

High-current terminal block - PTPOWER 95-3L-F - 3260121

Please be informed that the data shown in this PDF Document is generated from our Online Catalog. Please find the complete data in the user's documentation. Our General Terms of Use for Downloads are valid (<http://phoenixcontact.com/download>)

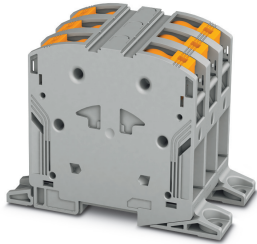

High-current terminal block, Blocked, nom. voltage: 1000 V, nominal current: 232 A, connection method: Power-Turn connection, 1 level, cross section: 25 mm² - 95 mm², mounting type: direct screw connection, color: gray

Your advantages

- ✓ Quick and easy connection is now also possible for large conductors with the high-current terminal block
- ✓ In addition to using the existing test connection, pick-off terminal blocks can be connected, each of which can also accommodate two test cables
- ✓ The Push-in connection terminal blocks are characterized by the system features of the CLIPLINE complete system and by easy and tool-free wiring of conductors with ferrules or solid conductors
- ✓ The compact design enables wiring in a confined space



Key Commercial Data

Packing unit	1 pc
Minimum order quantity	3 pc
GTIN	 4 046356 778992
GTIN	4046356778992
Weight per Piece (excluding packing)	620.000 g
Custom tariff number	85369010
Country of origin	Poland

Technical data

General

Number of positions	3
Number of rows	1
Number of connections	6
Potentials	3

High-current terminal block - PTPOWER 95-3L-F - 3260121

Technical data

General

Nominal cross section	95 mm ²
Color	gray
Insulating material	PA
Flammability rating according to UL 94	V0
Mounting type	direct screw connection
Rated surge voltage	8 kV
Degree of pollution	3
Overvoltage category	III
Insulating material group	I
Maximum power dissipation for nominal condition	7.54 W
Maximum load current	232 A (with 95 mm ² conductor cross section)
Nominal current I _N	232 A
Nominal voltage U _N	1000 V
Open side panel	No
Relative insulation material temperature index (Elec., UL 746 B)	130 °C
Temperature index of insulation material (DIN EN 60216-1 (VDE 0304-21))	125 °C
Static insulating material application in cold	-60 °C
Surface flammability NFPA 130 (ASTM E 162)	passed
Specific optical density of smoke NFPA 130 (ASTM E 662)	passed
Calorimetric heat release NFPA 130 (ASTM E 1354)	27,5 MJ/kg
Smoke gas toxicity NFPA 130 (SMP 800C)	passed
Fire protection for rail vehicles (DIN EN 45545-2) R22	HL 1 - HL 3
Fire protection for rail vehicles (DIN EN 45545-2) R23	HL 1 - HL 3
Fire protection for rail vehicles (DIN EN 45545-2) R24	HL 1 - HL 3
Fire protection for rail vehicles (DIN EN 45545-2) R26	HL 1 - HL 3

Dimensions

Width	75 mm
Length	139.1 mm
Height	99.8 mm
Hole diameter	6.5 mm
Drill hole spacing	126.4 mm
Pitch	25 mm

Connection data

Connection	1 level
Connection method	Power-Turn connection
Stripping length	40 mm

High-current terminal block - PTPOWER 95-3L-F - 3260121

Technical data

Connection data

Connection in acc. with standard	IEC 60947-7-1
Conductor cross section solid min.	25 mm ²
Conductor cross section solid max.	95 mm ²
Conductor cross section AWG min.	4
Conductor cross section AWG max.	4/0
Conductor cross section flexible min.	25 mm ²
Conductor cross section flexible max.	95 mm ²
Min. AWG conductor cross section, flexible	4
Max. AWG conductor cross section, flexible	4/0
Conductor cross section flexible, with ferrule without plastic sleeve min.	25 mm ²
Conductor cross section flexible, with ferrule without plastic sleeve max.	95 mm ²
Conductor cross section flexible, with ferrule with plastic sleeve min.	25 mm ²
Conductor cross section flexible, with ferrule with plastic sleeve max.	95 mm ²
Cross section with insertion bridge, solid max.	95 mm ²
Cross section with insertion bridge, stranded max.	70 mm ²
Connection cross sections directly pluggable	25 mm ² 95 mm ²
Conductor cross section solid min.	25 mm ²
Conductor cross section solid max.	95 mm ²
Conductor cross section flexible, with ferrule without plastic sleeve min.	25 mm ²
Conductor cross section flexible, with ferrule without plastic sleeve max.	95 mm ²
Conductor cross section flexible, with ferrule with plastic sleeve min.	25 mm ²
Conductor cross section flexible, with ferrule with plastic sleeve max.	95 mm ²

Ambient conditions

Operating temperature	-60 °C ... 105 °C (max. short-term operating temperature RTI Elec.)
Ambient temperature (storage/transport)	-25 °C ... 60 °C (for a short time, not exceeding 24 h, -60 °C to +70 °C)
Permissible humidity (storage/transport)	30 % ... 70 %
Ambient temperature (assembly)	-5 °C ... 70 °C
Ambient temperature (actuation)	-5 °C ... 70 °C

Standards and Regulations

Connection in acc. with standard	IEC 60947-7-1
----------------------------------	---------------

Environmental Product Compliance

China RoHS	Environmentally friendly use period: unlimited = EFUP-e
	No hazardous substances above threshold values

Drawings

High-current terminal block - PTPOWER 95-3L-F - 3260121

Circuit diagram



Schematic diagram

PTPOWER

AGK 10-PTPOWER	0,5 mm ² ... 16 mm ²	18 mm
PTPOWER 35	2,5 mm ² ... 35 mm ²	25 mm
PTPOWER 50	10 mm ² ... 50 mm ²	32 mm
PTPOWER 95	25 mm ² ... 95 mm ²	40 mm
PTPOWER 185	95 mm ² ... 185 mm ²	40 mm

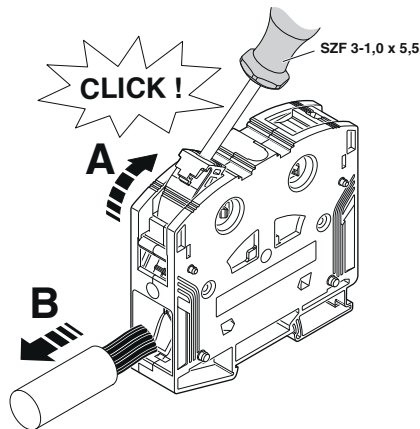

Dimensional drawing

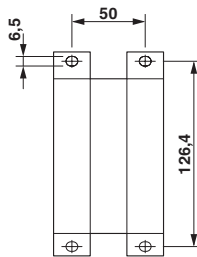

Classifications

eCl@ss

eCl@ss 10.0.1	27141120
eCl@ss 11.0	27141120
eCl@ss 4.0	27141100
eCl@ss 4.1	27141100
eCl@ss 5.0	27141100
eCl@ss 5.1	27141100
eCl@ss 6.0	27141100

High-current terminal block - PTPOWER 95-3L-F - 3260121

Classifications

eCl@ss

eCl@ss 7.0	27141120
eCl@ss 9.0	27141120

ETIM

ETIM 3.0	EC000897
ETIM 4.0	EC000897
ETIM 6.0	EC000897
ETIM 7.0	EC000897

UNSPSC

UNSPSC 6.01	30211811
UNSPSC 7.0901	39121410
UNSPSC 11	39121410
UNSPSC 12.01	39121410
UNSPSC 13.2	39121410
UNSPSC 18.0	39121410
UNSPSC 19.0	39121410
UNSPSC 20.0	39121410
UNSPSC 21.0	39121410

Approvals

Approvals

Approvals

DNV GL / CSA / UL Recognized / cUL Recognized / EAC / EAC / cULus Recognized

Ex Approvals

Approval details

DNV GL		https://approvalfinder.dnvgl.com/	TAE00000Z9
--------	--	---	------------

High-current terminal block - PTPOWER 95-3L-F - 3260121

Approvals

CSA		http://www.csagroup.org/services-industries/product-listing/	13631
	B	C	
Nominal voltage UN	600 V	1000 V	
Nominal current IN	230 A	230 A	
mm ² /AWG/kcmil	4	4	

UL Recognized		http://database.ul.com/cgi-bin/XYV/template/LISEXT/1FRAME/index.htm	FILE E 60425
---------------	---	---	--------------

cUL Recognized		http://database.ul.com/cgi-bin/XYV/template/LISEXT/1FRAME/index.htm	FILE E 60425
	C		
Nominal voltage UN	1000 V		
Nominal current IN	230 A		
mm ² /AWG/kcmil	4		

EAC			RU C- DE.AI30.B.01102
-----	---	--	--------------------------

EAC			RU C- DE.BL08.B.00644
-----	---	--	--------------------------

cULus Recognized			
------------------	---	--	--

Accessories

Accessories

Crimping tool

High-current terminal block - PTPOWER 95-3L-F - 3260121

Accessories

Crimping pliers - CRIMPFOX 25R - 1212039



Crimping pliers, for ferrules without insulating collar according to DIN 46228 Part 1 and ferrules with insulating collar according to DIN 46228 Part 4, 10 mm² ... 25 mm², lateral entry, WM crimp

Crimping pliers - CRIMPFOX 50R - 1212041



Crimping pliers, for ferrules without insulating collar according to DIN 46228 Part 1 and ferrules with insulating collar according to DIN 46228 Part 4, 35 mm² ... 50 mm², lateral entry, WM crimp

Crimping pliers - CRIMPFOX-M - 1212072



Basic pliers, for accommodating dies for a wide range of type of contacts

Crimping pliers - CRIMPFOX-C120 - 1212318



Basic pliers, for accommodating dies for a wide range of type of contacts up to 120 mm²

Documentation

Mounting material - PTPOWER-IL - 1180891



Operating decal for the PTPOWER

High-current terminal block - PTPOWER 95-3L-F - 3260121

Accessories

Ferrule

Ferrule - A 25 -40 - 3241238



Ferrule, length: 40 mm, color: silver

Ferrule - A 35 -40 - 3241239



Ferrule, length: 40 mm, color: silver

Ferrule - A 50 -40 - 3241240



Ferrule, length: 40 mm, color: silver

Ferrule - A 70 -40 - 3241241



Ferrule, length: 40 mm, color: silver

Ferrule - A 95 -40 - 3241242



Ferrule, length: 40 mm, color: silver

High-current terminal block - PTPOWER 95-3L-F - 3260121

Accessories

Insertion bridge

Insertion bridge - EB 2-25/PT - 3260157



Insertion bridge, pitch: 25 mm, color: red

Insertion bridge - EB 3-25/PT - 3260160



Insertion bridge, pitch: 25 mm, color: red

Insertion bridge - EB 4-25/PT - 3260161



Insertion bridge, pitch: 25 mm, color: red

Insertion bridge - EBK 4-25/PT - 3260162



Short-circuit jumper for grounding and short-circuiting, short-circuit currents of 800 A/15 s, 1300 A/5 s, 2700 A/10 ms, length: 74.5 mm, width: 140.5 mm, number of positions: 3, color: green-yellow

Insulating sleeve

Insulating sleeve - MPS-IH WH - 0201663



Insulating sleeve, color: white

High-current terminal block - PTPOWER 95-3L-F - 3260121

Accessories

Insulating sleeve - MPS-IH RD - 0201676

Insulating sleeve, color: red



Insulating sleeve - MPS-IH BU - 0201689

Insulating sleeve, color: blue



Insulating sleeve - MPS-IH YE - 0201692

Insulating sleeve, color: yellow



Insulating sleeve - MPS-IH GN - 0201702

Insulating sleeve, color: green



Insulating sleeve - MPS-IH GY - 0201728

Insulating sleeve, color: gray



High-current terminal block - PTPOWER 95-3L-F - 3260121

Accessories

Insulating sleeve - MPS-IH BK - 0201731

Insulating sleeve, color: black



Labeled terminal marker

Zack marker strip - ZB 10 CUS - 0824941



Zack marker strip, can be ordered: Strip, white, labeled according to customer specifications, mounting type: snap into tall marker groove, for terminal block width: 10.2 mm, lettering field size: 10.15 x 10.5 mm, Number of individual labels: 10

Zack marker strip - ZB10,LGS:FORTL.ZAHLEN - 1053014



Zack marker strip, Strip, white, labeled, can be labeled with: CMS-P1-PLOTTER, printed horizontally: consecutive numbers 1 ... 10, 11 ... 20, etc. up to 91 ... 100, mounting type: snap into tall marker groove, for terminal block width: 10.2 mm, lettering field size: 10.15 x 10.5 mm, Number of individual labels: 10

Zack marker strip - ZB10,QR:FORTL.ZAHLEN - 1053027



Zack marker strip, Strip, white, labeled, can be labeled with: CMS-P1-PLOTTER, Printed vertically: consecutive numbers 1 ... 10, 11 ... 20, etc. up to 91 ... 100, mounting type: snap into tall marker groove, for terminal block width: 10.2 mm, lettering field size: 10.15 x 10.5 mm, Number of individual labels: 10

Marker for terminal blocks - ZB10,LGS:L1-N,PE - 1053412



Marker for terminal blocks, Strip, white, labeled, can be labeled with: CMS-P1-PLOTTER, horizontal: L1, L2, L3, N, PE, L1, L2, L3, N, PE, mounting type: snap into tall marker groove, for terminal block width: 10.2 mm, lettering field size: 10.15 x 10.5 mm, Number of individual labels: 10

High-current terminal block - PTPOWER 95-3L-F - 3260121

Accessories

Marker for terminal blocks - ZB10,LGS:U-N - 1053438



Marker for terminal blocks. Strip, white, labeled, can be labeled with: CMS-P1-PLOTTER, horizontal: U, V, W, N, GND, U, V, W, N, GND, mounting type: snap into tall marker groove, for terminal block width: 10.2 mm, lettering field size: 10.15 x 10.5 mm, Number of individual labels: 10

Marker for terminal blocks - UC-TM 10 CUS - 0824605



Marker for terminal blocks, can be ordered: by sheet, white, labeled according to customer specifications, mounting type: snap into tall marker groove, for terminal block width: 10.2 mm, lettering field size: 9.6 x 10.5 mm, Number of individual labels: 48

Marker for terminal blocks - UCT-TM 10 CUS - 0829623



Marker for terminal blocks, can be ordered: by sheet, white, labeled according to customer specifications, mounting type: snap into tall marker groove, for terminal block width: 10.2 mm, lettering field size: 8.9 x 9.6 mm, Number of individual labels: 36

Zack Marker strip, flat - ZBF10 CUS - 0825031



Zack Marker strip, flat, can be ordered: Strip, white, labeled according to customer specifications, mounting type: snap into flat marker groove, for terminal block width: 10 mm, lettering field size: 5.15 x 10 mm, Number of individual labels: 10

Zack Marker strip, flat - ZBF10,LGS:FORTL.ZAHLEN - 0810009



Zack Marker strip, flat, Strip, white, labeled, printed horizontally: consecutive numbers 1 ... 10, 11 ... 20, etc. up to 91 ... 100, mounting type: snap into flat marker groove, for terminal block width: 10 mm, lettering field size: 5.15 x 10 mm, Number of individual labels: 10

High-current terminal block - PTPOWER 95-3L-F - 3260121

Accessories

Zack Marker strip, flat - ZBF10,QR:FORTL.ZAHLEN - 0810025



Zack Marker strip, flat, Strip, white, labeled, Printed vertically: consecutive numbers 1 ... 10, 11 ... 20, etc. up to 91 ... 100, mounting type: snap into flat marker groove, for terminal block width: 10 mm, lettering field size: 5.15 x 10 mm, Number of individual labels: 10

Marker for terminal blocks - UC-TMF 10 CUS - 0824662



Marker for terminal blocks, can be ordered: by sheet, white, labeled according to customer specifications, mounting type: snap into flat marker groove, for terminal block width: 10.2 mm, lettering field size: 9.6 x 5.1 mm, Number of individual labels: 48

Marker for terminal blocks - UCT-TMF 10 CUS - 0829679



Marker for terminal blocks, can be ordered: by sheet, white, labeled according to customer specifications, mounting type: snap into flat marker groove, for terminal block width: 10.2 mm, lettering field size: 9.4 x 4.7 mm, Number of individual labels: 36

Pick-off terminal block

Pick-off terminal block - AGK 10-PTPOWER - 3260145



Pick-off terminal block, For use with PTPOWER 50, 95, 150, and 185 Power-Turn high-current terminal blocks, nom. voltage: 1500 V, nominal current: 57 A, connection method: Push-in connection, 1 level, Rated cross section: 10 mm², cross section: 0.5 mm² - 16 mm², mounting type: on base element, color: gray

Pick-off terminal block - AGK 10-PTPOWER BU - 3260148



Pick-off terminal block, For use with PTPOWER 50, 95, 150, and 185 Power-Turn high-current terminal blocks, nom. voltage: 1500 V, nominal current: 57 A, connection method: Push-in connection, 1 level, Rated cross section: 10 mm², cross section: 0.5 mm² - 16 mm², mounting type: on base element, color: blue

High-current terminal block - PTPOWER 95-3L-F - 3260121

Accessories

Pick-off terminal block - AGK 10-PTPOWER GN/YE - 3260151



Pick-off terminal block, For use with PTPOWER 50, 95, 150, and 185 Power-Turn high-current terminal blocks, nom. voltage: 1500 V, nominal current: 57 A, connection method: Push-in connection, 1 level, Rated cross section: 10 mm², cross section: 0.5 mm² - 16 mm², mounting type: on base element, color: green/yellow

Pick-off terminal block - AGK 10-PTPOWER BK/YE - 3260154



Pick-off terminal block, For use with PTPOWER 50, 95, 150, and 185 Power-Turn high-current terminal blocks, nom. voltage: 1500 V, nominal current: 57 A, connection method: Push-in connection, 1 level, Rated cross section: 10 mm², cross section: 0.5 mm² - 16 mm², mounting type: on base element, color: black/yellow

Planning and marking software

Software - PROJECT COMPLETE - 1050453



Intuitive planning and marking software for configuring terminal strips and for professional marking of marking materials for terminal blocks, conductors, cables, devices, and systems. The software is available for download

Screwdriver tools

Screwdriver - SZF 3-1,0X5,5 - 1206612



Actuation tool, for ST terminal blocks, also suitable for use as a bladed screwdriver, size: 1.0 x 5.5 x 150 mm, 2-component grip, with non-slip grip

Terminal marking

High-current terminal block - PTPOWER 95-3L-F - 3260121

Accessories

Zack marker strip - ZB 10:UNBEDRUCKT - 1053001



Zack marker strip, Strip, white, unlabeled, can be labeled with: PLOTMARK, CMS-P1-PLOTTER, mounting type: snap into tall marker groove, for terminal block width: 10.2 mm, lettering field size: 10.5 x 10.15 mm, Number of individual labels: 10

Marker for terminal blocks - UC-TM 10 - 0818069



Marker for terminal blocks, Sheet, white, unlabeled, can be labeled with: BLUEMARK ID COLOR, BLUEMARK ID, BLUEMARK CLED, PLOTMARK, CMS-P1-PLOTTER, mounting type: snap into tall marker groove, for terminal block width: 10.2 mm, lettering field size: 9.6 x 10.5 mm, Number of individual labels: 48

Marker for terminal blocks - UCT-TM 10 - 0829142



Marker for terminal blocks, Sheet, white, unlabeled, can be labeled with: TOPMARK NEO, TOPMARK LASER, BLUEMARK ID COLOR, BLUEMARK ID, BLUEMARK CLED, THERMOMARK PRIME, THERMOMARK CARD 2.0, THERMOMARK CARD, mounting type: snap into tall marker groove, for terminal block width: 10.2 mm, lettering field size: 8.9 x 9.6 mm, Number of individual labels: 36

Zack Marker strip, flat - ZBF10:UNBEDRUCKT - 0809997



Zack Marker strip, flat, Strip, white, unlabeled, can be labeled with: CMS-P1-PLOTTER, PLOTMARK, mounting type: snap into flat marker groove, for terminal block width: 10 mm, lettering field size: 5.15 x 10 mm, Number of individual labels: 10

Marker for terminal blocks - UC-TMF 10 - 0818124



Marker for terminal blocks, Sheet, white, unlabeled, can be labeled with: BLUEMARK ID COLOR, BLUEMARK ID, BLUEMARK CLED, PLOTMARK, CMS-P1-PLOTTER, mounting type: snap into flat marker groove, for terminal block width: 10.2 mm, lettering field size: 9.6 x 5.1 mm, Number of individual labels: 48

High-current terminal block - PTPOWER 95-3L-F - 3260121

Accessories

Marker for terminal blocks - UCT-TMF 10 - 0829204



Marker for terminal blocks, Sheet, white, unlabeled, can be labeled with: TOPMARK NEO, TOPMARK LASER, BLUEMARK ID COLOR, BLUEMARK ID, BLUEMARK CLED, THERMOMARK PRIME, THERMOMARK CARD 2.0, THERMOMARK CARD, mounting type: snap into flat marker groove, for terminal block width: 10.2 mm, lettering field size: 9.4 x 4.7 mm, Number of individual labels: 36

Test plug terminal block

Test plugs - MPS-MT - 0201744



Test plugs, with solder connection up to 1 mm² conductor cross section, color: gray

Warning label printed

Cover - CEC PTPOWER 95/185 - 1056087



Cover, yellow, labeled: Lightning flash, mounting type: plug in