

Photovoltaic MOSFET Driver

Product Catalog

**IN Your
Future**

Photovoltaic MOSFET Driver

Photovoltaic MOSFET drivers of wide variation

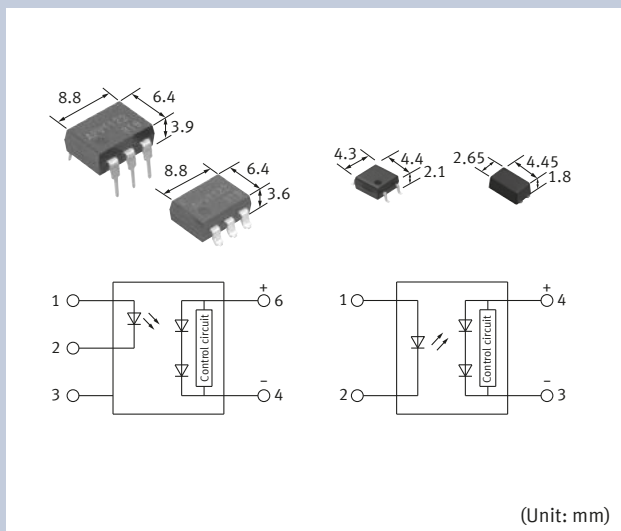

FEATURES

- High-speed switching
- High insulation
DIP type: 5,000 Vrms, SOP type: 2,500 Vrms, SSOP type: 1,500 Vrms
- Extensive product lineup
Products include SSOP, SOP4-pin and DIP6-pin.

TYPICAL APPLICATIONS

- Power supply (Vcc) for electronic circuits
- Driving MOSFET

Note) This product is not for automotive use.
Please contact our sales representative for automotive applications.

TYPES

Package	Output rating		Part No.				Packing quantity	
	Drop-out voltage (Typ.)	Short circuit current (Typ.)	Through hole terminal	Surface mount terminal			Tube	Tape and reel
			Tube packing style	Tube packing style	Tape and reel packing style X, Y*1	Tape and reel packing style 1Y		
DIP6-pin	8.7 V	14 μ A	APV1122	APV1122A	APV1122AX	—	1-tube : 50 pcs. Outer carton: 500 pcs.	1-reel : 1,000 pcs. Outer carton: 1,000 pcs.
SOP4-pin*2	8.7 V	14 μ A	—	APV1121S	APV1121SX	—	1-tube : 100 pcs. Outer carton: 2,000 pcs.	1-reel : 1,000 pcs. Outer carton: 1,000 pcs.
	8.2 V	8 μ A	—	APV2121S	APV2121SX	—		
SSOP*3	8.2 V	8 μ A	—	—	APV2111VY	APV2111V1Y	—	Packing style Y 1-reel : 3,500 pcs. Outer carton: 3,500 pcs. Packing style 1Y 1-reel : 1,000 pcs. Outer carton: 1,000 pcs.

*1: DIP type is picked from 1/2/3-pin side, SOP type is picked from 1/2-pin side, SSOP type is picked from 1/4-pin side.

For DIP type picked from the 4/6-pin side, for the SOP type picked from the 3/4-pin side and for the SSOP type picked from the 2/3-pin side, please change the part number "X" at the end to "Z" or "Y" to "W" when ordering.

*2: For space reasons, the two initial letters of the part number "AP", package (SOP) indicator "S" and the packing style indicator "X" are not marked on the device. (Ex. the label for product number APV1121SX is V1121.)

*3: For space reasons, the two initial letters of the part number "AP", package (SSOP) indicator "V" and the packing style are not marked on the device. (Ex. the label for product number APV2111VY is V2111.)

Photovoltaic MOSFET Driver

RATING

Absolute maximum ratings (Ambient temperature: 25 °C)

Item	Symbol	APV1122 (A)	APV1121S	APV2121S	APV2111V	Remarks
Input	LED forward current	I_F	50 mA			
	LED reverse voltage	V_R	5 V			
	Peak forward current	I_{FP}	1 A			f = 100 Hz, Duty Ratio = 0.1 %
	Power dissipation	P_{in}	75 mW			
I/O isolation voltage	V_{iso}	5,000 Vrms	2,500 Vrms	2,500 Vrms	1,500 Vrms	
Ambient temperature (Operating)	T_{opr}	-40 to + 85 °C				(Avoid icing and condensation)
Ambient temperature (Storage)	T_{stg}	-40 to +100 °C				
Junction temperature	T_j	125 °C				

Electrical characteristics (Ambient temperature: 25 °C)

Item	Symbol	APV1122 (A)	APV1121S	APV2121S	APV2111V	Condition
Input	LED operate current	Typical	0.6 mA		0.85 mA	$V_{oc} = 5 V$
		Maximum	3.0 mA			
	LED turn off current	Minimum	0.2 mA			$V_{oc} = 1 V$
		Typical	0.5 mA	0.75 mA		
LED dropout voltage	Typical	1.15 V			$I_F = 10 mA$	
	Maximum	1.5 V				
Output	Drop-out voltage*1	Minimum	6 V	5 V		$I_F = 10 mA$
		Typical	8.7 V	8.2 V		
	Short circuit current*2	Minimum	5 μA	3 μA		$I_F = 10 mA$
Typical	14 μA	8 μA				
Transfer characteristics	Turn on time*3	Typical	0.4 ms	0.8 ms		$I_F = 10 mA$ $C_L = 1,000 pF$
	Turn off time*3	Typical	0.1 ms			$I_F = 10 mA$ $C_L = 1,000 pF$
	I/O capacitance	Typical	0.8 pF			f = 1 MHz $V_b = 0 V$
		Maximum	1.5 pF			
Initial I/O isolation resistance	Minimum	1,000 M Ω			500 V DC	

*1: Drop-out voltage measurement circuit

APV1122 (A)

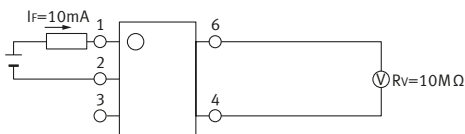

APV1121S, APV2121S, APV2111V

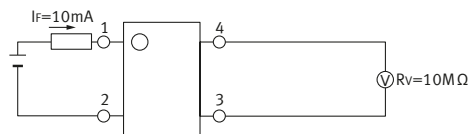

*2: Short circuit current measurement circuit

APV1122 (A)

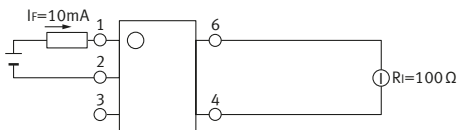

APV1121S, APV2121S, APV2111V

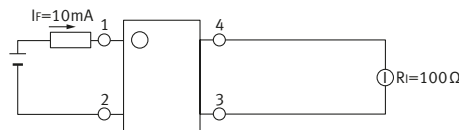

*3: Turn on/Turn off time measurement circuit

APV1122 (A)

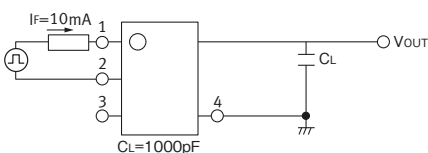

APV1121S, APV2121S, APV2111V

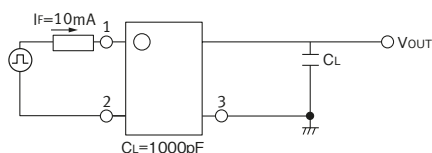

*3: Turn off time

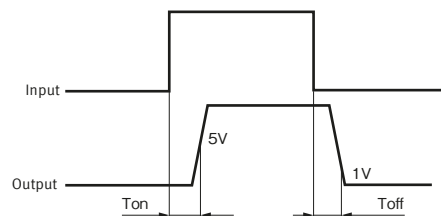

Photovoltaic MOSFET Driver

Recommended operating conditions (Ambient temperature: 25°C)

Please use under recommended operating conditions to obtain expected characteristics.

Item	Symbol	Min.	Max.	Unit
LED current	I_f	10	30	mA

REFERENCE DATA

1. Drop-out voltage vs. ambient temperature characteristics

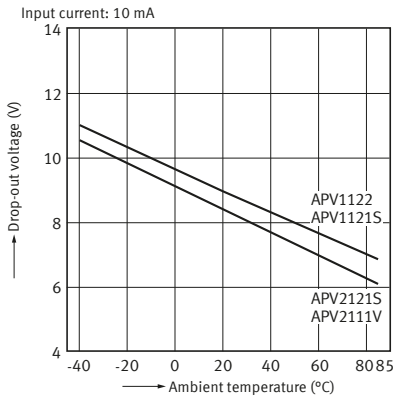

2. Short circuit current vs. ambient temperature characteristics

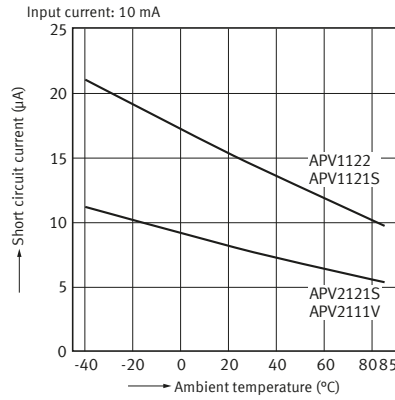

3. LED operate current vs. ambient temperature characteristics

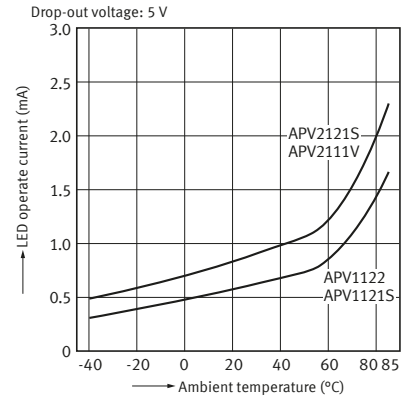

4. LED turn off current vs. ambient temperature characteristics

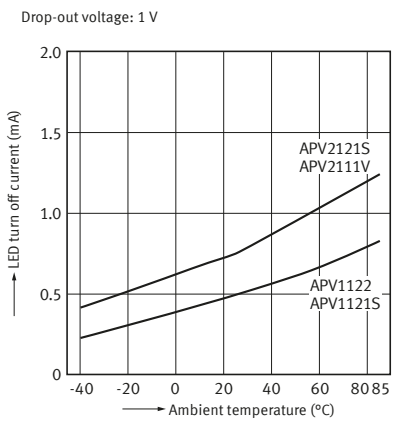

5. LED dropout voltage vs. ambient temperature characteristics

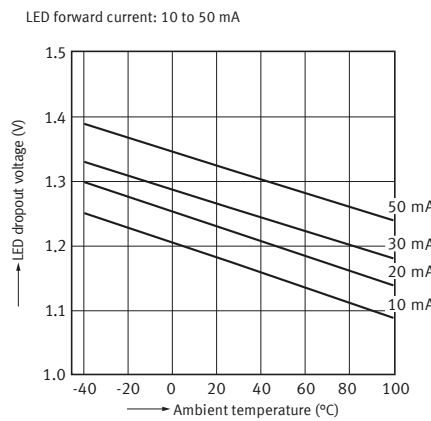

6. Turn on time vs. ambient temperature characteristics

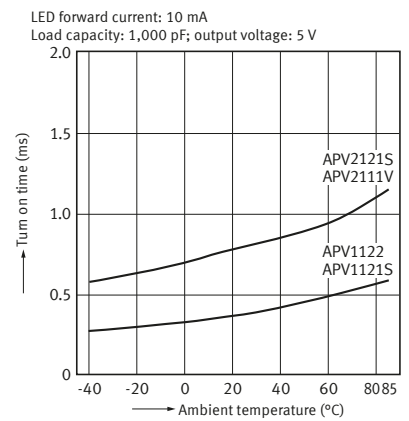

7. Turn off time vs. ambient temperature characteristics

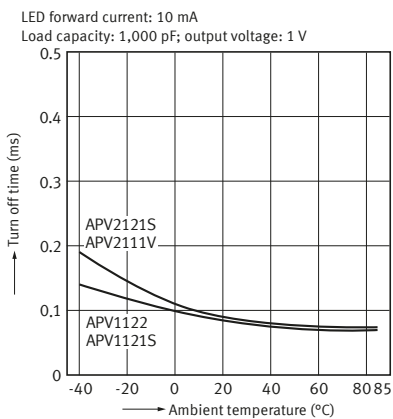

8. Turn on time vs. LED forward current characteristics

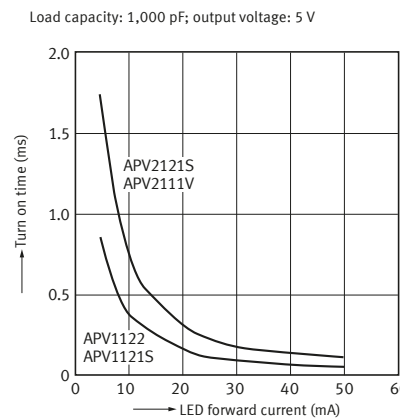

9. Turn off time vs. LED forward current characteristics

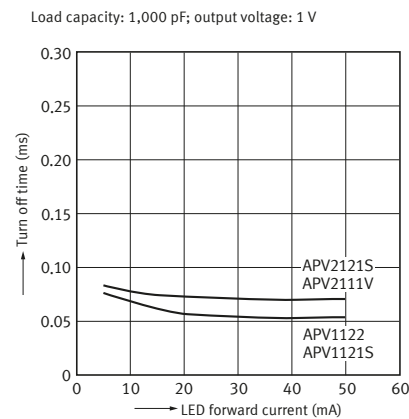

Photovoltaic MOSFET Driver

10. Drop-out voltage vs. LED forward current characteristics

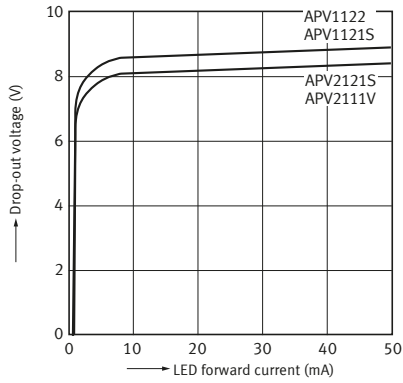

11. Short circuit current vs. LED forward current characteristics

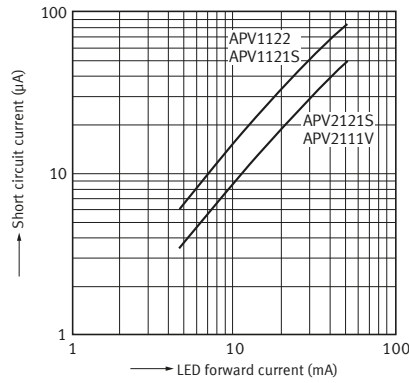

DIMENSIONS (Unit: mm)

CAD The CAD data of the products with a "CAD" mark can be downloaded from our Website.

DIP6-pin

CAD Through hole terminal type External dimensions

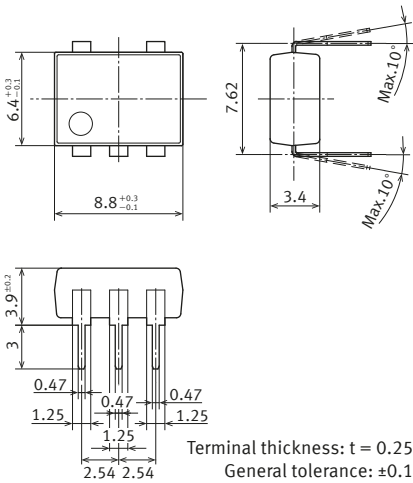

CAD Surface mount terminal type External dimensions

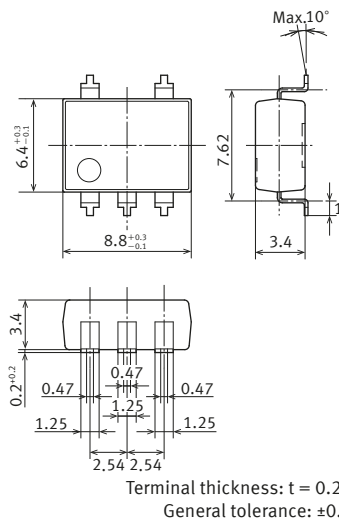

PC board pattern (BOTTOM VIEW)

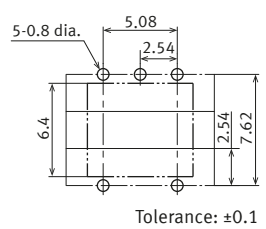

Recommended mounting pad (TOP VIEW)

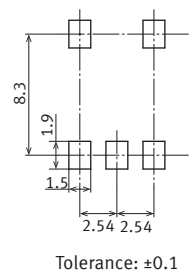

SOP4-pin

CAD



External dimensions

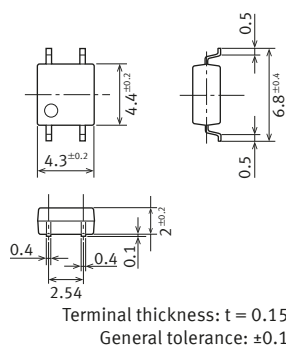

Recommended mounting pad (TOP VIEW)

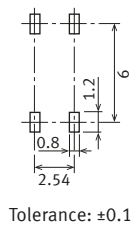

Photovoltaic MOSFET Driver

■ SSOP

CAD



External dimensions

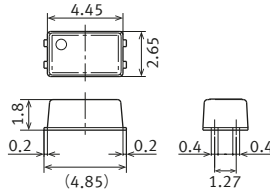

Terminal thickness: $t = 0.15$
General tolerance: ± 0.1

Recommended mounting pad
(TOP VIEW)

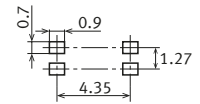

Tolerance: ± 0.1

SCHEMATIC AND WIRING DIAGRAMS

Schematic	Output configuration	Load type	Connection	Wiring diagram
	1 Form A	—	—	

* Terminal 3 cannot be used, since it is in the internal circuit of the device.

SAFETY STANDARDS

Each standard may be updated at any time, so please check our Website for the latest information.

Part No.		UL (Recognized)		VDE (Certified)	
		File No. (Standard No.)	Contact rating	File No. (Standard No.)	Contact rating
Photovoltaic MOSFET driver	APV2111V (SSOP)	E191218 (UL1577)	—	Nr. 40051981 (EN62368-1)	—
	APV2121S (SOP)		—		—
	APV1121S (SOP)		—		—
	APV1122 (DIP6)		—		—

Please refer to " the latest product specifications " when designing your product.

- Requests to customers:
<https://industry.panasonic.com/global/en/salespolicies>

⚠ SAFETY WARNINGS

- Do not use the product under conditions that exceed the range of its specifications. It may cause overheating, smoke, or fire.
- Do not touch the recharging unit while the power is on. There is a danger of electrical shock. Be sure to turn off the power when performing mounting, maintenance, or repair operations on the device (including connecting parts such as the terminal board and socket).
- Check the wiring diagrams in the catalog and be sure to connect the terminals correctly. If the device is energized with short circuit or any wrong connection, it may cause unexpected malfunction, abnormal heat or fire.

PhotoMOS[®] Cautions for Use

■ Derating design

Derating is a significant factor for reliable design and product life. Even if the conditions of use (temperature, current, voltage, etc.) of the product are within the absolute maximum ratings, reliability may be lowered remarkably when continuously used in high load conditions (high temperature, high humidity, high current, high voltage, etc.) Therefore, please derate sufficiently below the absolute maximum ratings and evaluate the device in the actual condition.

Moreover, regardless of the application, if malfunctioning can be expected to pose high risk to human life or to property, or if products are used in equipment otherwise requiring high operational safety, in addition to designing double circuits, that is, incorporating features such as a protection circuit or a redundant circuit, safety testing should also be carried out.

■ Applying stress that exceeds the absolute maximum rating

If the voltage or current value for any of the terminals exceeds the absolute maximum rating, internal elements will deteriorate because of the overvoltage or overcurrent. In extreme cases, wiring may melt, or silicon P/N junctions may be destroyed.

Therefore, the circuit should be designed in such a way that the load never exceed the absolute maximum ratings, even momentarily.

■ Input voltage (for Voltage-sensitive type)

For rising and dropping ratio of input voltage (dv/dt), maintain Min. 100 mV/ms.

■ Oscillation circuit and control circuit (for CC Type)

The oscillation circuit and control circuit of product may be destroyed by external noise, surge, static electricity and so on.

For noise effect to peripheral circuits when oscillation circuit operates, please implement safety measures on the system before use by verifying operation under the actual design.

■ Deterioration and destruction caused by discharge of static electricity

This phenomenon is generally called static electricity destruction, and occurs when static electricity generated by various factors is discharged while the PhotoMOS terminals are in contact, producing internal destruction of the element.

To prevent problems from static electricity, the following precautions and measures should be taken when using your device.

- 1) Employees handling PhotoMOS should wear anti-static clothing and should be grounded through protective resistance of 500 k Ω to 1 M Ω .
- 2) A conductive metal sheet should be placed over the worktable. Measuring instruments and jigs should be grounded.
- 3) When using soldering irons, either use irons with low leakage current, or ground the tip of the soldering iron. (Use of low-voltage soldering irons is also recommended.)
- 4) Devices and equipment used in assembly should also be grounded.
- 5) When packing printed circuit boards and equipment, avoid using high-polymer materials such as foam styrene, plastic, and other materials which carry an electrostatic charge.
- 6) When storing or transporting PhotoMOS, the environment should not be conducive to generating static electricity (for instance, the humidity should be between 45 % and 60 %), and PhotoMOS should be protected using conductive packing materials.

■ Unused terminals

The No. 3 terminal is used with the circuit inside the device. Therefore, do not connect it to the external circuitry with either connection method A, B or C. (1 Form A 6-pin type)

■ Short across terminals

Do not short circuit between terminals when device is energized, since there is possibility of breaking of the internal IC.

PhotoMOS® Cautions for Use

Surge voltages at the input

If reverse surge voltages are present at the input terminals, connect a diode in reverse parallel across the input terminals and keep the reverse voltages below the reverse breakdown voltage.

Typical circuits are below shown.

1) 6-pin

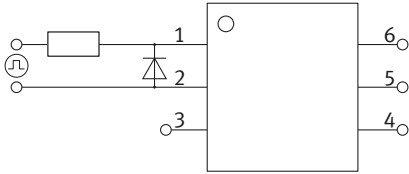

2) Power type

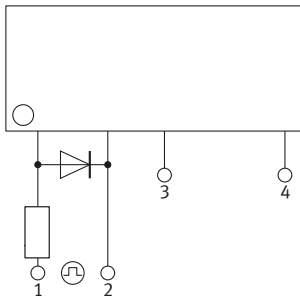

Reverse voltages at the input (for CC Type)

If reverse voltages are present at the input terminals, for example, connect a schottky barrier diode in reverse parallel across the input terminals and keep the reverse voltages below the reverse breakdown voltage. Typical circuit is shown below.

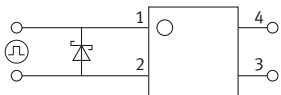

Recommended LED forward current or recommended input voltage

Design in accordance with the recommended operating conditions for each product.

Since these conditions are affected by the operating environment, ensure conformance with all relevant specifications.

LED forward current vs. Ambient temperature characteristics

Please keep the LED forward current to within the range given below.

(*Please check the reference data in each catalog for products with maximum ambient temperature (operating) over 85 °C.)

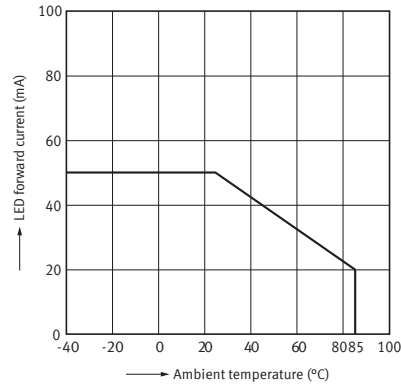

For AQP209G, APV1111GV, APV3111GV

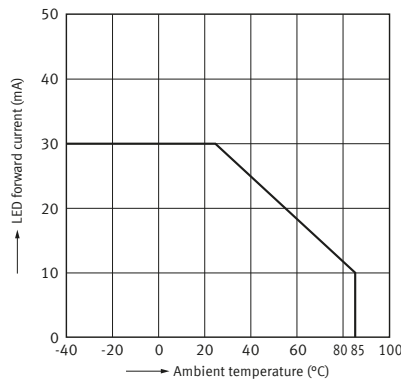

PhotoMOS® Cautions for Use

■ Ripple in the input power supply

If ripple is present in the input power supply, observe the following:

- 1) For LED forward current at Emin, please maintain the value mentioned at " ■Recommended LED forward current. "
- 2) Please make sure for the LED forward current at Emax. is less than the current value of the " ■Absolute maximum ratings " .
- 3) Please maintain the input voltage at least 4 V for Emin. (GU, RF and Power voltage-sensitive type) .
- 4) Please make sure the input voltage for Emax. is no higher than 6 V (GU and RF voltage-sensitive type) .
- 5) Please make sure the input voltage for Emax. is no higher than 30 V (Power voltage-sensitive type) .
- 6) Please maintain the input voltage at least 3 V for Emin. (for CC Type)
- 7) Please make sure the input voltage for Emax. is no higher than 5.5 V. (for CC Type)

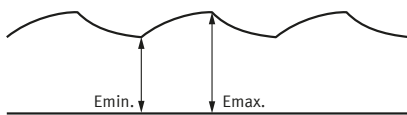

- 8) Please keep amplitude voltage of ripple within ± 0.5 V. (for CC Type)

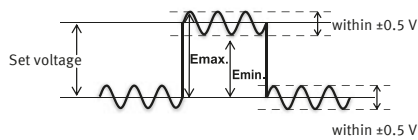

■ Output spike voltages

- 1) If an inductive load generates spike voltages which exceed the absolute maximum rating, the spike voltage shall be limited. Representative circuit examples of AC/DC dual use type are shown below. There are the same with DC only type.

(1) 6-pin

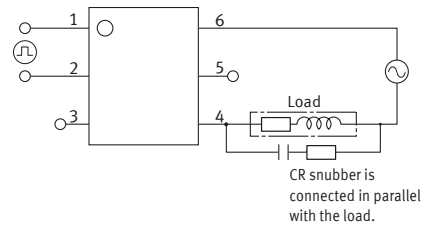
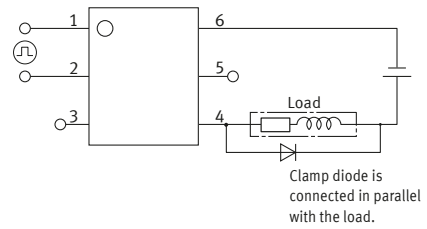

(2) Power type

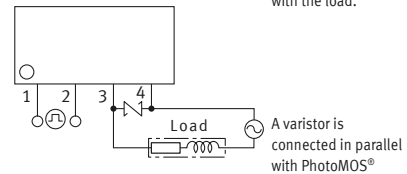
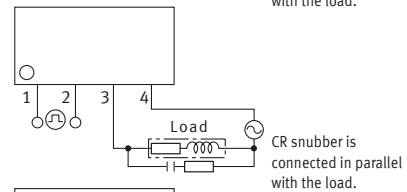
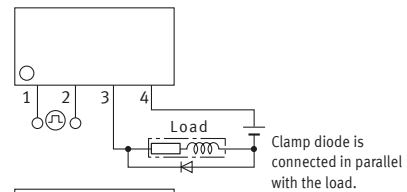

(3) CC Type

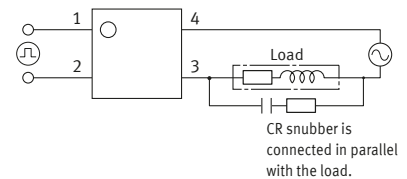
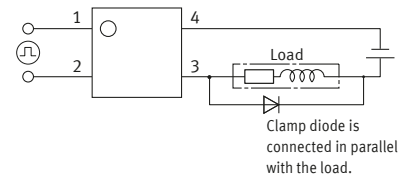

- 2) When Clamp diode or CR Snubber is used in the circuit, the spike voltages from the load are limited. But the longer wire may become the inductance and cause the spike voltage. Keep the wire as short as possible.

■ Output Waveform (CC Type)

This product has the capacitor coupled isolation. Therefore, if output waveform fluctuates along the time axis (e.g. AC waveform or pulsating waveform), it may affect the operation of this product and peripheral circuit. Please evaluate the device in the actual condition.

■ Continual DC bias (AQP259 and AQP258)

If a continual DC bias will be applied between the input and output, the breakdown voltage of the switching element MOSFET on the output side may degrade. Therefore, be sure to test the product under actual conditions. Example of circuits that will cause degradation of breakdown voltage of MOSFET is given below.

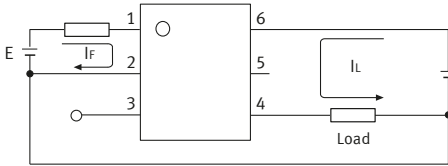

■ Connections Between Input and Output (CC Type)

If you wish to use the product with a connection between input and output, you may not obtain expected performance. Therefore, please be sure to evaluate the device in the actual usage. A circuit example is shown below that may negatively affect PhotoMOS characteristics.

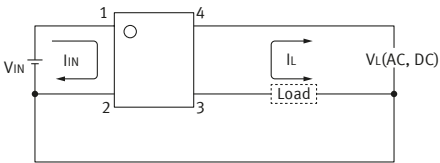

■ Cleaning solvents compatibility

Cleaning the solder flux should use the immersion washing with an organic solvent. If you have to use ultrasonic cleaning, please adopt the following conditions and check that there are no problems in the actual usage.

- Frequency: 27 to 29 kHz
- Ultrasonic output: No greater than 0.25 W/cm²*
- Cleaning time: 30 s or less
- Others: Float PC board and the device in the cleaning solvent to prevent from contacting the ultrasonic vibrator

* Applies to unit area ultrasonic output for ultrasonic baths

■ Notes for mounting

- 1) When different kinds of packages are mounted on PC board, temperature rise at soldering lead is highly dependent on package size. Therefore, please set the lower temperature soldering condition than the conditions of item " ■Soldering " , and confirm the temperature condition of actual usage before soldering.
- 2) When soldering condition exceeds our recommendation, the PhotoMOS characteristics may be adversely affected. It may occur package crack or bonding wire breaking because of thermal expansion nonconformity and resin strength reduction. Please contact our sales office about the propriety of the condition.
- 3) Please confirm the heat stress by using actual board because it may be changed by board condition or manufacturing process condition.
- 4) Solder creepage, wettability, or soldering strength will be affected by the soldering condition or used soldering type. Please check them under the actual production condition in detail.
- 5) Please apply coating when the device returns to a room temperature.

■ Input wiring pattern

- 1) With AQY* or AQW* series avoid installing the input (LED side) wiring pattern to the bottom side of the package if you require the specified I/O isolation voltage (Viso) after mounting the PC board. Since part of the frame on the output side is exposed, it may cause fluctuations in the I/O isolation voltage.

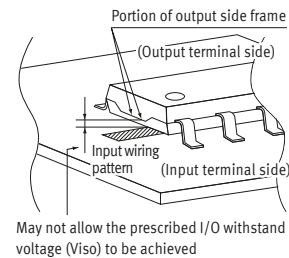

* Excluding high I/O isolation voltage products and SSOP, SON, and TSON packages

- 2) Exposed terminals are electrically connected to internal elements. Be aware that contact with external circuits may cause deterioration of insulation between input and output, leading to destruction of internal elements.
- 3) If installed in proximity to other device, take care to avoid short circuits between device, which may occur if exposed frames of adjacent device come too close.

■ Soldering

1) Example of surface-mount terminal recommended conditions

(1) IR (Infrared reflow) soldering method

In case of automatic soldering, following conditions should be observed. (recommended condition reflow: Max. 2 times, measurement point: soldering lead)

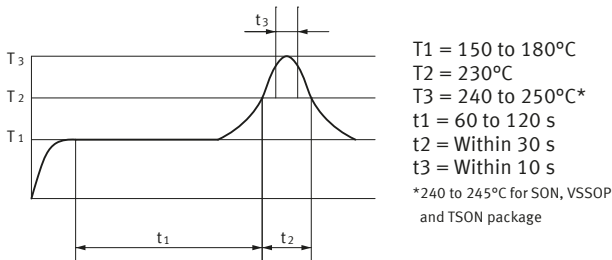

(*Some products have different recommended conditions. Please check " the latest product specifications " .)

(2) Other soldering methods

Other soldering methods (VPS, hot-air, hot plate, laser heating, pulse heater, etc.) affect the PhotoMOS characteristics differently, please evaluate the device under the actual usage.

(3) Manual soldering method

Temperature: 350 to 400 °C, within 3 s, electrical power 30 to 60 W

2) Example of through hole terminal recommended conditions

(1) DWS soldering method

In case of automatic soldering, following conditions should be observed.

(recommended condition number of times: Max. 1 time, measurement point: soldering lead *1)

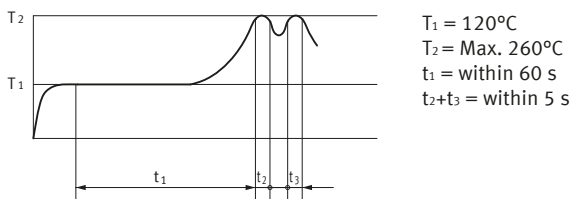

*1: Solder temperature: Max. 260 °C

(2) Other soldering method

(recommended condition: 1 time)

Preheating: Max. 120 °C, within 120 s, measurement point: soldering lead

Soldering: Max. 260 °C, within 10 s, measurement area: soldering temperature

(3) Manual soldering method

Temperature: 350 to 400 °C, within 3 s, electrical power 30 to 60 W

■ About the exposed terminals on the sides of the package (for VSSOP, WSSOP)

For VSSOP and WSSOP type, as shown in the following figure, part of the input and output frames are exposed on the sides of the package. Due to this, please be keep in mind the cautions listed below.

- 1) Take care to avoid short circuits between exposed terminals, which may cause insulation deterioration between input and output, leading to destruction of internal elements.
- 2) Since the exposed terminals are connected electrically to the internal element, please refer to the item " ■Deterioration and destruction caused by discharge of static electricity " , and implement sufficient measures to control static electricity.
- 3) When installing the devices in the vicinity, please keep in mind that if the exposed frames of adjacent devices get too close, a short between devices may occur.

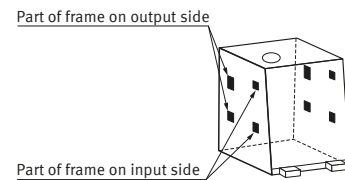

(Example: VSSOP type)

■ Adjacent mounting

When several PhotoMOS are mounted closely each other or heat-generating components are mounted close to the PhotoMOS, the abnormal heating may occur. This abnormal heat may be caused by the internal element when energized or thermal interference between the devices. The degree of temperature rise depends on the mounting layout of the devices and usage condition, therefore please be sure to use PhotoMOS with reduced load current after testing under the worst condition of the actual usage.

■ Transportation and storage

- 1) Extreme vibration during transport may deform the lead or damage the PhotoMOS characteristics. Please handle the outer and inner boxes with care.
- 2) Inadequate storage condition may degrade soldering, appearance, and characteristics. The following storage conditions are recommended:
 - Temperature: 0 to 45 °C
 - Humidity: Max. 70 % RH
 - Atmosphere: No harmful gasses such as sulfurous acid gas, minimal dust.
- 3) Storage before TSON, VSSOP, WSSOP, SON, SSOP, or SOP processing

In case the heat stress of soldering is applied to the PhotoMOS which absorbs moisture inside of its package, the evaporation of the moisture increases the pressure inside the package and it may cause the package blister or crack. This device is sensitive to moisture and it is packed in the sealed moisture-proof package. Please make sure the following condition after unsealing.

 - * Please use the device immediately after unsealing. (Within 30 days at 0 to 30 °C and Max. 70 % RH)
 - * If the device will be kept for a long time after unsealing, please store in another moisture-proof package containing silica gel. (Please use within 90 days.)

■ Water condensation

Water condensation occurs when the ambient temperature changes suddenly from a high temperature to low temperature at high humidity, or the device is suddenly transferred from a low ambient temperature to a high temperature and humidity. Condensation causes the failures such as insulation deterioration.

Panasonic Industry Co., Ltd. does not guarantee the failures caused by water condensation. The heat conduction by the equipment the PhotoMOS is mounted may accelerate the water condensation. Please confirm that there is no condensation in the worst condition of the actual usage. (Special attention should be paid when high temperature heating parts are close to the PhotoMOS.)

■ About foreign matter between the output terminals (AQY206GV)

The distance between the output terminals of this device is short. If foreign matter is caught between the output terminals after mounting on the PC board, it will result in a leakage path. This leakage path increases the leakage current, which results in your products to malfunction. Additionally, the leakage path causes abnormal heat generation and short circuiting, which results in the destruction of your products.

Although the absolute maximum load voltage rating is guaranteed for this device, please ensure the prevention of foreign matter on the area between the output terminals and evaluate this device in the most extreme conditions of actual usage.

PhotoMOS® Cautions for Use

■ Packing format

1) Tape and reel

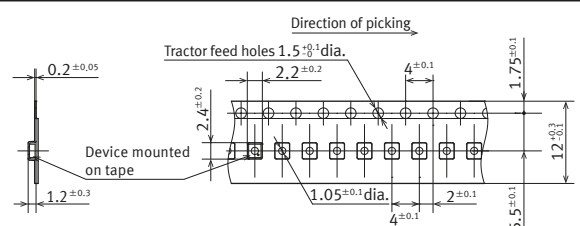
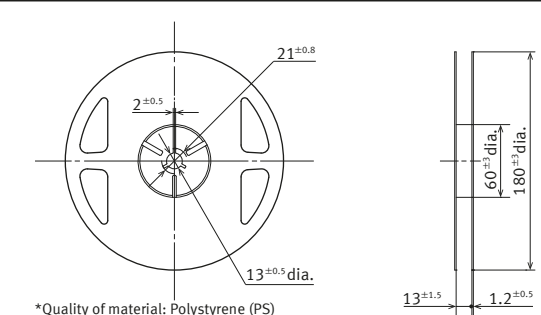
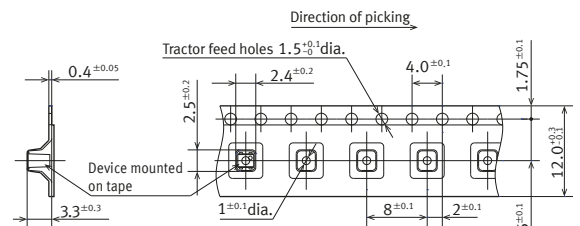
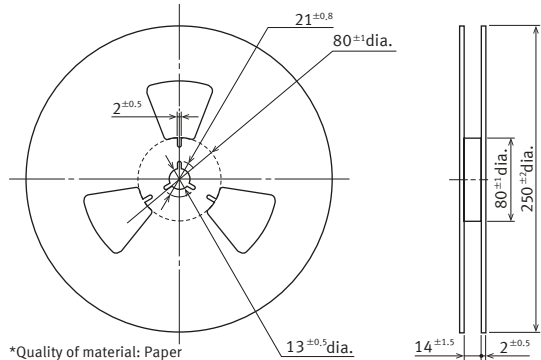
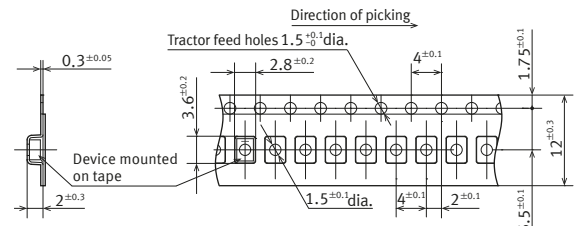
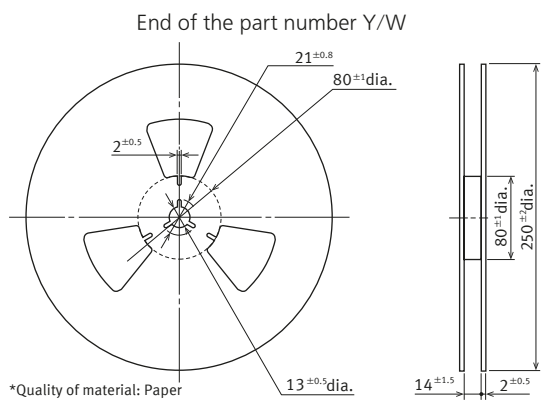
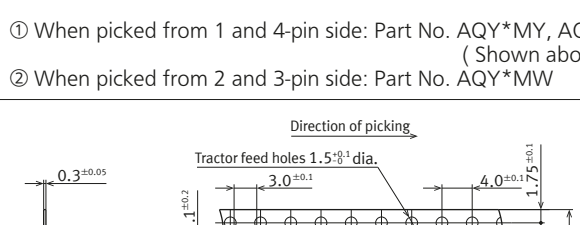
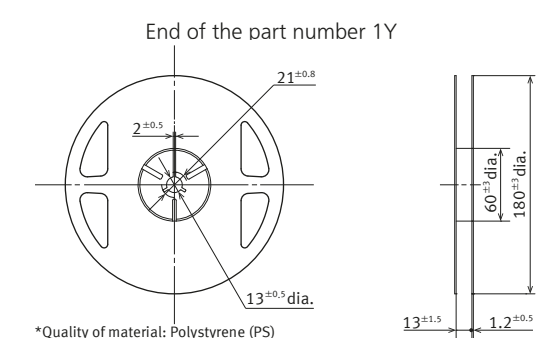
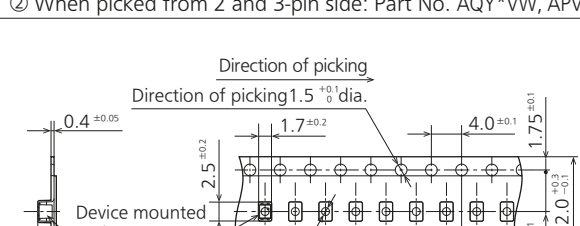
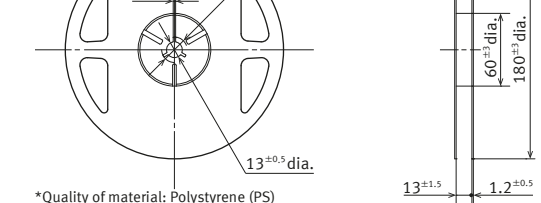
	Tape dimensions	Dimensions of tape reel
TSOP 4-pin	 <p>Direction of picking</p> <p>Tractor feed holes 1.5^{+0.1} dia.</p> <p>0.2^{±0.05}</p> <p>2.2^{±0.2}</p> <p>4^{±0.1}</p> <p>1.75^{±0.1}</p> <p>1.2^{±0.3}</p> <p>2.4^{±0.2}</p> <p>1.05^{±0.1} dia.</p> <p>2^{±0.1}</p> <p>4^{±0.1}</p> <p>5.5^{±0.1}</p> <p>12.0^{+0.3}</p> <p>Device mounted on tape</p>	 <p>21^{±0.8}</p> <p>2^{±0.5}</p> <p>13^{±0.5} dia.</p> <p>60⁺¹ dia.</p> <p>180⁺¹ dia.</p> <p>13^{±1.5}</p> <p>1.2^{±0.5}</p> <p>*Quality of material: Polystyrene (PS)</p>
VSSOP 4-pin	 <p>Direction of picking</p> <p>Tractor feed holes 1.5^{+0.1} dia.</p> <p>0.4^{±0.05}</p> <p>2.5^{±0.2}</p> <p>2.4^{±0.2}</p> <p>4.0^{±0.1}</p> <p>1.75^{±0.1}</p> <p>3.3^{±0.3}</p> <p>1^{±0.1} dia.</p> <p>8^{±0.1}</p> <p>2^{±0.1}</p> <p>5.5^{±0.1}</p> <p>12.0^{+0.3}</p> <p>Device mounted on tape</p>	 <p>21^{±0.8}</p> <p>80^{±1} dia.</p> <p>2^{±0.5}</p> <p>13^{±0.5} dia.</p> <p>80⁺¹ dia.</p> <p>250⁺² dia.</p> <p>14^{±1.5}</p> <p>2^{±0.5}</p> <p>*Quality of material: Paper</p>
SON 4-pin	 <p>Direction of picking</p> <p>Tractor feed holes 1.5^{+0.1} dia.</p> <p>0.3^{±0.05}</p> <p>2.8^{±0.2}</p> <p>4^{±0.1}</p> <p>1.75^{±0.1}</p> <p>2^{±0.3}</p> <p>3.6^{±0.2}</p> <p>1.5^{±0.1} dia.</p> <p>4^{±0.1}</p> <p>2^{±0.1}</p> <p>5.5^{±0.1}</p> <p>12.0^{+0.3}</p> <p>Device mounted on tape</p>	 <p>End of the part number Y/W</p> <p>21^{±0.8}</p> <p>80^{±1} dia.</p> <p>2^{±0.5}</p> <p>13^{±0.5} dia.</p> <p>80⁺¹ dia.</p> <p>250⁺² dia.</p> <p>14^{±1.5}</p> <p>2^{±0.5}</p> <p>*Quality of material: Paper</p>
SSOP 4-pin	 <p>Direction of picking</p> <p>Tractor feed holes 1.5^{+0.1} dia.</p> <p>0.3^{±0.05}</p> <p>3.0^{±0.1}</p> <p>4.0^{±0.1}</p> <p>1.75^{±0.1}</p> <p>2.7^{±0.3}</p> <p>5.1^{±0.2}</p> <p>1.5^{±0.1} dia.</p> <p>4.0^{±0.1}</p> <p>1.5^{±0.1} dia.</p> <p>5.5^{±0.1}</p> <p>12.0^{+0.3}</p> <p>Device mounted on tape</p>	 <p>End of the part number 1Y</p> <p>21^{±0.8}</p> <p>2^{±0.5}</p> <p>13^{±0.5} dia.</p> <p>80⁺¹ dia.</p> <p>250⁺² dia.</p> <p>14^{±1.5}</p> <p>2^{±0.5}</p> <p>*Quality of material: Paper</p>
WSSOP 4-pin	 <p>Direction of picking</p> <p>Direction of picking 1.5^{+0.1} dia.</p> <p>0.4^{±0.05}</p> <p>1.7^{±0.2}</p> <p>4.0^{±0.1}</p> <p>1.75^{±0.1}</p> <p>2.15^{±0.3}</p> <p>2.5^{±0.2}</p> <p>Φ1.0^{±0.1}</p> <p>4.0^{±0.1}</p> <p>2.0^{±0.1}</p> <p>5.5^{±0.1}</p> <p>12.0^{+0.3}</p> <p>Device mounted on tape</p>	 <p>21^{±0.8}</p> <p>2^{±0.5}</p> <p>13^{±0.5} dia.</p> <p>60⁺¹ dia.</p> <p>180⁺¹ dia.</p> <p>13^{±1.5}</p> <p>1.2^{±0.5}</p> <p>*Quality of material: Polystyrene (PS)</p>
	<p>① When picked from 1/2-pin side: Part No. AQY2C*R*PX, AQY2C*R*P1X (Shown above)</p> <p>② When picked from 3/4-pin side: Part No. AQY2C*R*PZ</p>	
	<p>① When picked from 1 and 4-pin side: Part No. AQY*TY (Shown above)</p> <p>② When picked from 2 and 3-pin side: Part No. AQY*TW</p>	
	<p>① When picked from 1 and 4-pin side: Part No. AQY*MY, AQY*M1Y (Shown above)</p> <p>② When picked from 2 and 3-pin side: Part No. AQY*MW</p>	
	<p>① When picked from 1 and 4-pin side: Part No. AQY*VY, AQY221*V1Y, APV*111*VY, APV*111*V1Y (Shown above)</p> <p>② When picked from 2 and 3-pin side: Part No. AQY*VW, APV*111*VW</p>	
	<p>When picked from 1 and 4-pin side: Part No. AQY*WY, AQY*W1Y</p>	

Note: " * " indicates characters of number or alphabet.

PhotoMOS® Cautions for Use

	Tape dimensions	Dimensions of tape reel
SOP 4-pin	<p>① When picked from 1/2-pin side: Part No. AQY*SX, APV**21SX (Shown above) ② When picked from 3/4-pin side: Part No. AQY*SZ, APV**21SZ</p>	<p>*Quality of material: Paper</p>
SOP 6-pin	<p>① When picked from 1/2/3-pin side: Part No. AQV*SX (Shown above) ② When picked from 4/5/6-pin side: Part No. AQV*SZ</p>	<p>*Quality of material: Paper</p>
SOP 8-pin	<p>① When picked from 1/2/3/4-pin side: Part No. AQW*SX (Shown above) ② When picked from 5/6/7/8-pin side: Part No. AQW*SZ</p>	<p>*Quality of material: Paper</p>
SOP 16-pin	<p>① When picked from 1/2/3/4/5/6/7/8-pin side: Part No. AQS*SX (Shown above) ② When picked from 9/10/11/12/13/14/15/16-pin side: Part No. AQS*SZ</p>	<p>*Quality of material: Paper</p>
DIP 4-pin Surface mount terminal	<p>① When picked from 1/2-pin side: Part No. AQY*HAX, AQY210HLAX (Shown above) ② When picked from 3/4-pin side: Part No. AQY*HAZ, AQY210HLAZ</p>	<p>*Quality of material: Paper</p>

Note: " * " indicates characters of number or alphabet.

PhotoMOS® Cautions for Use

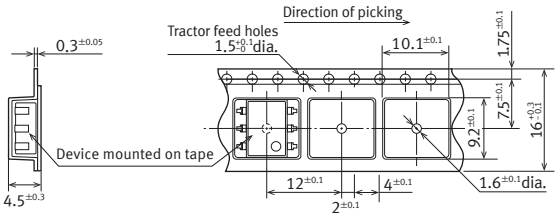
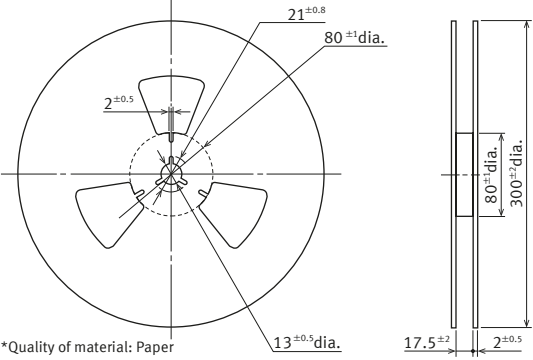
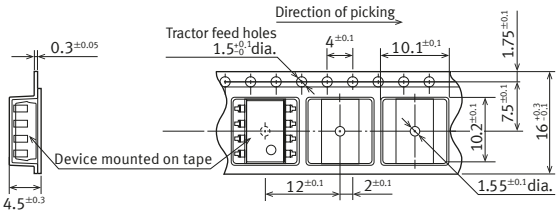
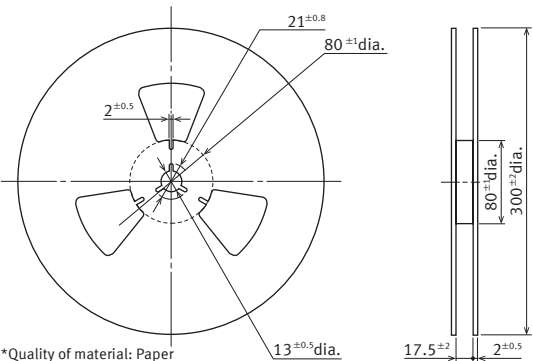
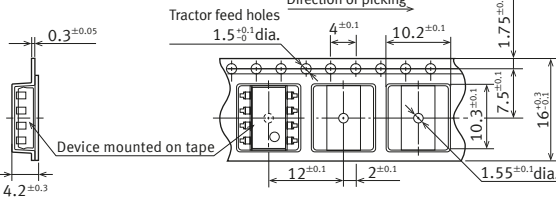
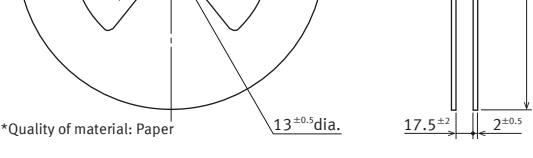
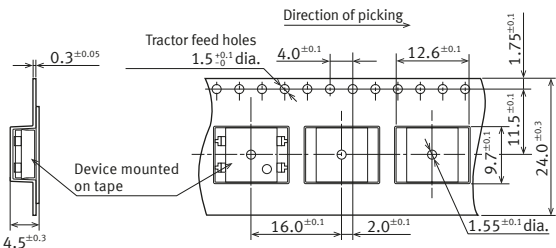
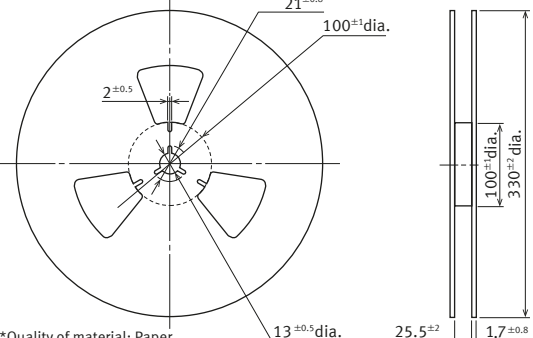
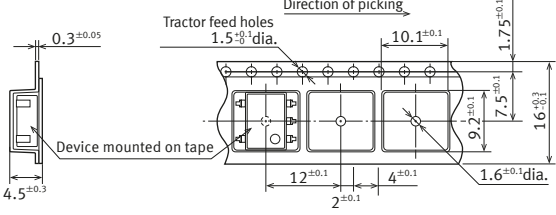
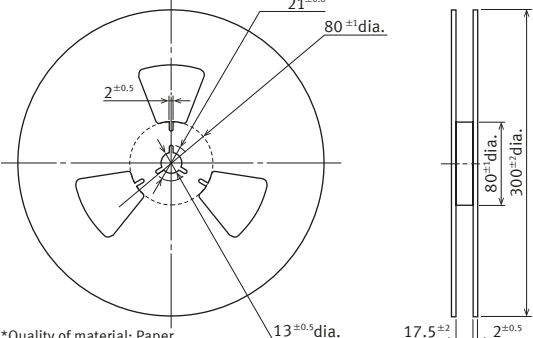
	Tape dimensions	Dimensions of tape reel
<p>DIP 6-pin Surface mount terminal</p>	 <p>① When picked from 1/2/3-pin side: Part No. AQV*AX (Shown above) ② When picked from 4/5/6-pin side: Part No. AQV*AZ</p>	 <p>*Quality of material: Paper</p>
<p>DIP 8-pin Surface mount terminal</p>	 <p>① When picked from 1/2/3/4-pin side: Part No. AQW*AX (Shown above) ② When picked from 5/6/7/8-pin side: Part No. AQW*AZ</p>	 <p>*Quality of material: Paper</p>
<p>DIP 8-pin Surface mount terminal High I/O isolation voltage type</p>	 <p>① When picked from 1/2/3/4-pin side: Part No. AQW*EHAX, AQW210HLAX (Shown above) ② When picked from 5/6/7/8-pin side: Part No. AQW*EHAZ, AQW210HLAZ</p>	 <p>*Quality of material: Paper</p>
<p>Power-DIP 4-pin Surface mount terminal</p>	 <p>① When picked from 1/2-pin side: Part No. AQY*AX (Shown above) ② When picked from 3/4-pin side: Part No. AQY*AZ</p>	 <p>*Quality of material: Paper</p>
<p>DIP 6-pin Surface mount terminal (Photovoltaic MOSFET driver)</p>	 <p>① When picked from 1/2/3-pin side: Part No. APV1122AX (Shown above) ② When picked from 4/6-pin side: Part No. APV1122AZ</p>	 <p>*Quality of material: Paper</p>

Note: " * " indicates characters of number or alphabet.

PhotoMOS® Cautions for Use

2) Tube

Devices are packaged in a tube so that 1-pin is on the stopper B side. Observe correct orientation when mounting them on PC boards.

(PD type)

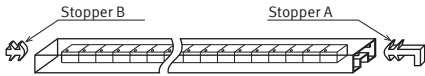

(DIP type)

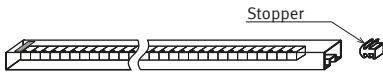

(SOP type)



(Power type)

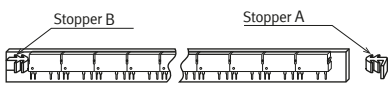

■ Current limit function (output current control)

1) Current limit function aims to increase resistance to surges when the switch is turned on. Before using this function, connect the varistor to the output as shown in the figure below.

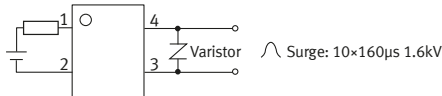

* Set the varistor voltage to 150 V or less.

2) The current limit function capability can be lost if used longer than the specified time. Be sure to set the output loss to the Max. rate.

■ Short circuit protection circuit

The short circuit protection circuit is designed to protect circuits from excess current. Therefore, surge current may be detected as current overload in which case the output current will be cut and the off state maintained. For this reason, please include the inrush current in the load current and keep it below the maximum load current.

Also, in order to maintain stability of internal IC operation, maintain an input current of at least 5 mA (Latch type) , 10 mA (Non Latch type) .

■ Photovoltaic MOSFET driver cautions for use

When two external MOSFETs are connected with a common source terminal, oscillation may occur when operation is restored. Therefore, please insert a 100 to 1,000 Ω resistor between the gate terminal of the first MOSFET and the gate terminal of the second MOSFET.

A typical example of this is given in the circuit below.

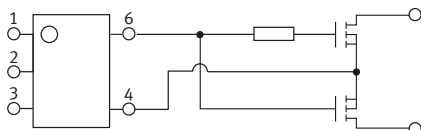

■ Input LED current

(For High Capacity type: with part number G)

When making PhotoMOS turn on and turn off, please make sure that the LED forward current increases and decreases instantly.

■ Input voltage

(for Power voltage-sensitive type)

For rising and dropping ratio of input voltage (dv/dt) , maintain Min. 100 mV/s.

■ Adjacent mounting (for Power type)

1) When devices are mounted close together with the heat-generated devices, ambient temperature may rise abnormally. Mounting layout and ventilation should be considered.

2) When many devices are mounted close together, load current should be reduced.
(Refer to the data of " Load current in adjacent mounting vs. Ambient temperature characteristics.")

PhotoMOS® Cautions for Use

■ Recommended load voltage

As a guide in selecting PhotoMOS, please refer to the following table.

1) Power PhotoMOS (1 Form A)

		Absolute maximum rating		Recommended load voltage
		Load voltage	Load current	
DC type	AQZ102	60 V DC	4.0 A DC	5, 12, 24 V DC
	AQZ105	100 V DC	2.6 A DC	48 V DC
	AQZ107	200 V DC	1.3 A DC	100 V DC
	AQZ104	400 V DC	0.7 A DC	200 V DC
AC/DC type	AQZ202	Peak AC, DC 60 V	Peak AC, DC 3.0 A	12 V AC 5, 12, 24 V DC
	AQZ205	Peak AC, DC 100 V	Peak AC, DC 2.0 A	24 V AC 48 V DC
	AQZ207	Peak AC, DC 200 V	Peak AC, DC 1.0 A	48 V AC 100 V DC
	AQZ204	Peak AC, DC 400 V	Peak AC, DC 0.5 A	120 V AC 200 V DC

2) Power PhotoMOS (1 Form B)

		Absolute maximum rating		Recommended load voltage
		Load voltage	Load current	
AC/DC type	AQZ404	Peak AC, DC 400 V	Peak AC, DC 0.5 A	100 V AC 200 V DC

3) Power PhotoMOS Voltage-sensitive type (1 Form A)

		Absolute maximum rating		Recommended load voltage
		Load voltage	Load current	
DC type	AQZ102D	60 V DC	3.6 A DC	5, 12, 24 V DC
	AQZ105D	100 V DC	2.3 A DC	48 V DC
	AQZ107D	200 V DC	1.1 A DC	100 V DC
	AQZ104D	400 V DC	0.6 A DC	200 V DC
AC/DC type	AQZ202D	Peak AC, DC 60 V	Peak AC, DC 2.7 A	12 V AC 5, 12, 24 V DC
	AQZ205D	Peak AC, DC 100 V	Peak AC, DC 1.8 A	24 V AC 48 V DC
	AQZ207D	Peak AC, DC 200 V	Peak AC, DC 0.9 A	48 V AC 100 V DC
	AQZ204D	Peak AC, DC 400 V	Peak AC, DC 0.45 A	120 V AC 200 V DC

4) Power PhotoMOS High Capacity type (1 Form A)

		Absolute maximum rating		Recommended load voltage
		Load voltage	Load current	
DC type	AQZ192	60 V DC	10 A DC	5, 12, 24 V DC
	AQZ197	200 V DC	5 A DC	100 V DC
AC/DC type	AQZ202G	Peak AC, DC 60 V	Peak AC, DC 6 A	12 V AC 5, 12, 24 V DC
	AQZ205G	Peak AC, DC 100 V	Peak AC, DC 4 A	24 V AC 48 V DC
	AQZ207G	Peak AC, DC 200 V	Peak AC, DC 2 A	48 V AC 100 V DC
	AQZ206G2	Peak AC, DC 600 V	Peak AC, DC 1 A	120, 240 V AC 200, 400 V DC

■ Global Sales Network Information: industry.panasonic.com/global/en/salesnetwork/globalnetwork

Panasonic
INDUSTRY

Panasonic Industry Co., Ltd.

Electromechanical Control Business Division

■ 1006, Oaza Kadoma, Kadoma-shi, Osaka 571-8506, Japan
industry.panasonic.com