

LED Driver ICs

ICL8001G / ICLS8082G

Design Guidelines

Phase-Cut-Dimmable Single-Stage LED Driver with PFC
using Quasi-Resonant Primary Power Control

Version 2.0

Application Note

Version 2.0, 2011-04-14

Industrial & Multimarket

Edition 2011-04-14

**Published by
Infineon Technologies AG
81726 Munich, Germany**

**© 2011 Infineon Technologies AG
All Rights Reserved.**

Legal Disclaimer

The information given in this document shall in no event be regarded as a guarantee of conditions or characteristics. With respect to any examples or hints given herein, any typical values stated herein and/or any information regarding the application of the device, Infineon Technologies hereby disclaims any and all warranties and liabilities of any kind, including without limitation, warranties of non-infringement of intellectual property rights of any third party.

Information

For further information on technology, delivery terms and conditions and prices, please contact the nearest Infineon Technologies Office (www.infineon.com).

Warnings

Due to technical requirements, components may contain dangerous substances. For information on the types in question, please contact the nearest Infineon Technologies Office.

Infineon Technologies components may be used in life-support devices or systems only with the express written approval of Infineon Technologies, if a failure of such components can reasonably be expected to cause the failure of that life-support device or system or to affect the safety or effectiveness of that device or system. Life support devices or systems are intended to be implanted in the human body or to support and/or maintain and sustain and/or protect human life. If they fail, it is reasonable to assume that the health of the user or other persons may be endangered.

ICL8001G / ICLS8082G Design Guidelines

werner.ludorf@infineon.com

Revision History: 2011-04-14, Version 2.0

Previous Revision:

Page	Subjects (major changes since last revision)
	First edition

Table of Contents

	Table of Contents	4
1	Introduction	5
2	Pin Configuration and Functionality	6
2.1	Pin Configuration with PG-DSO-8	6
2.2	Package PG-DSO-8	7
2.3	Pin Functionality	7
3	Control Principle	8
4	Design Parameters	9
4.1	Transformer Parameters	9
4.2	Power Switch	10
4.3	Primary Peak Current Control	11
4.4	Foldback Correction	12
4.5	Switch-on Determination for Quasi-resonant Operation	13
4.6	Power Factor Correction	14
4.7	VCC for Dimming	14
5	Design Optimizations	15
5.1	Dimming	15
5.1.1	Dimming Principle	15
5.1.2	Dimmer Compatibility	17
5.1.3	Dimmer List	18
5.1.4	Dimmer Selection	19
5.2	Power Stabilization for Line Voltage Variations	19
5.2.1	Stabilization using IC Foldback Correction	19
5.2.2	Discrete Power Stabilization Circuit for ICL8001G	20
5.3	Optimized Power Factor Correction Performance	22
6	Protection Functions	23
6.1	Output OVP	23
6.2	Output Short Circuit Protection	23
6.3	Input Overvoltage Protection (OVP)	23
7	Explicit Questions and Answers	24
7.1	Application	24
7.2	Control Principle	24
8	References	25

1 Introduction

Objective

The objective of this application note is to describe how a dimmable, highly efficient single-stage LED driver based on the ICL8001G / ICLS8082G primary control developed by Infineon Technologies AG can be designed and how different design targets can be considered. For this purpose, quantitative design tools for dimensioning of the flyback transformer for QR (quasi-resonant) operation and further discrete components relevant to the power factor correction (PFC) and dimming control functions are provided. The design process refers to a concrete application example of a phase cut dimmable LED driver. Explicit questions and answers are treated in conclusion.

Features of ICL8001G / ICLS8082G control

- High, stable efficiency over a wide operating range
- Optimized for trailing and leading-edge dimmers
- Precise PWM for primary PFC and dimming control
- HV power cell for VCC precharging with a constant current
- Built-in digital soft start
- Foldback correction and cycle-by-cycle peak current limitation
- VCC over/undervoltage lockout
- Auto restart mode for short circuit protection
- Adjustable latch-off mode for output overvoltage protection (OVP)

Description

The ICL8001G / ICLS8082G employs a quasi-resonant (QR) operation mode and, due to the availability of outstanding PFC performance, is optimized for off-line LED lighting applications such as dimmable LED bulbs for incandescent lamp replacement, LED downlights and LED tubes in a power range from typically 5 W to 50 W. Precise PWM generation enables primary control for phase cut dimming and potential for high power factors of $PF > 99\%$. Depending on the power class, significantly improved driver efficiency of up to 91 % is feasible. The product has a wide operation range of IC voltage supply and low power consumption. Multiple safety functions ensure full system protection in failure situations. With its full feature set and simple application, the ICL8001G / ICLS8082G represents an outstanding choice for QR flyback designs combining feature set and performance at a minimum BOM cost.

2.2 Package PG-DSO-8

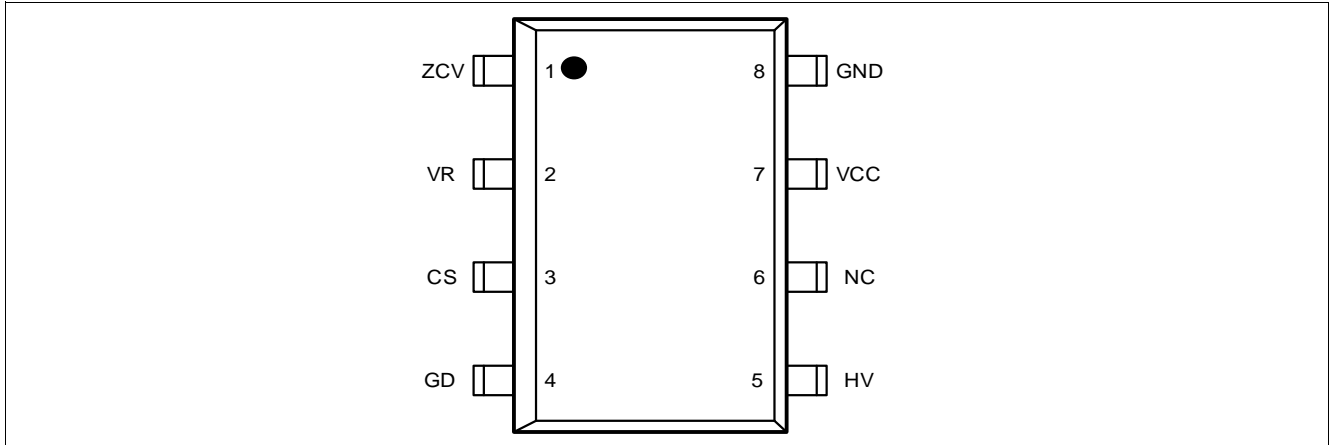

Figure 2 Pin Configuration of PG-DSO-8 (top view)

2.3 Pin Functionality

ZCV (Zero Crossing)

The voltage from the auxiliary winding after a time delay circuit is applied at this pin. Internally, the pin is connected to the zero-crossing detector for switch-on determination. Additionally, the output overvoltage detection is realized by comparing the voltage V_{zc} with an internal preset threshold.

VR (Voltage Sense)

The rectified input mains voltage is sensed at this pin. The signal is used to set the peak current of the peak-current control and therefore enable the PFC and phase-cut dimming functionality.

CS (Current Sense)

This pin is connected to the shunt resistor for the primary current sensing, externally, and to the PWM signal generator for switch-off determination (together with the feedback voltage), internally. Moreover, short-winding protection is realized by monitoring the voltage V_{cs} during on-time of the main power switch.

GD (Gate Drive Output)

This output signal drives the external main power switch, which is a power MOSFET in most cases.

HV (High Voltage)

The HV pin is connected to the bus voltage, externally, and to the power cell, internally. The current through this pin precharges the VCC capacitor with a constant current once the supply bus voltage is applied.

VCC (Power supply)

The VCC pin is the positive supply of the IC. The operating range is between V_{VCCoff} and V_{VCCOVp} .

GND (Ground)

This is the common ground of the controller.

3 Control Principle

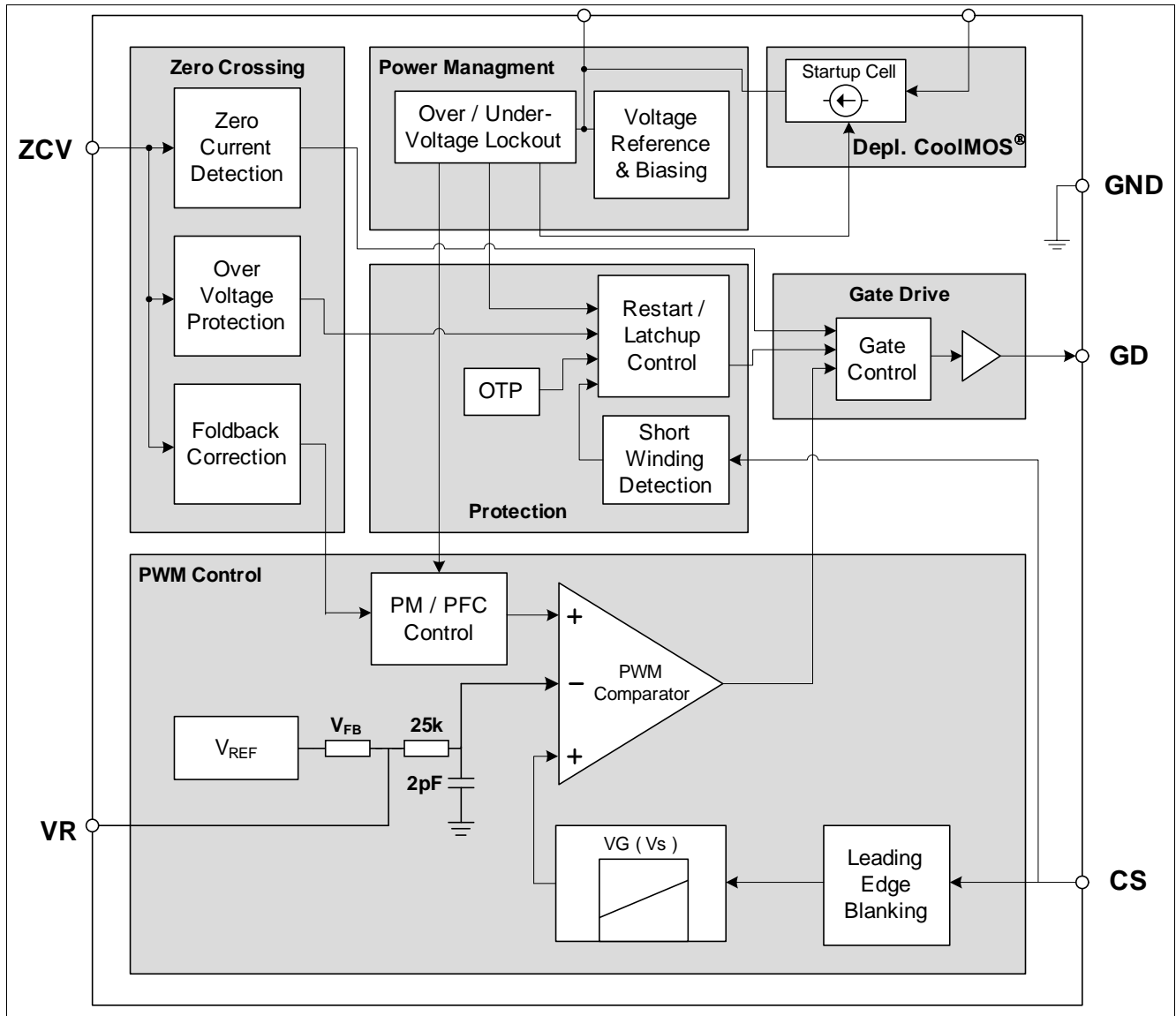

Figure 3 Block diagram of the ICL8001G

An inspection of the ICL8001G block diagram shows that the voltage measured at the shunt resistor R_s (see also the application circuit in [Figure 1](#)), which varies according to the instant transformer primary current $I_p(t)$, determines the gain voltage V_G as

$$V_G(I_p(t)) = G_{PWM} I_p(t) R_s + V_{PWM} \quad (1)$$

With the PWM OP gain G_{PWM} and the offset voltage V_{PWM} V_G is compared to the voltage VR , which is derived from the input voltage divider (R_o , R_u). This means that the peak current through the power switch Q1 and the primary inductance L varies according to the instant input voltage $V_{in}(t)$ as expressed by

$$I_p(t) \approx \frac{R_u}{R_o + R_u} \frac{V_{in}(t)}{G_{PWM} R_s} \quad (2)$$

It can be seen in the non-dimming case that a sinusoidal waveform of the primary peak current is dominant, which defines the almost sinusoidal shape of the input current $i_{in}(t)$. Beside the PFC function [Equation \(2\)](#) above shows that during phase cut dimming the input current will follow the phase cut-modified input voltage, which assures the dependence of the driver output power on the RMS input voltage V_{rms} according to the law described by [Equation \(24\)](#) on page [15](#).

4 Design Parameters

This chapter presents the essential design process and illustrates it in parallel with concrete values which are considered for a sample design with the main target magnitudes $V_{LED} = 27\text{ V}$, $I_{LED} = 360\text{ mA}$, $PF = 98\%$, $\eta = 90\%$, $f < f_{max} = 100\text{ kHz}$ for the input parameters $V_{in} = 230\text{ V}$, $f_{in} = 50\text{ Hz}$ and $P_{in} = V_{LED} I_{LED} / (\eta PF)$. The values chosen for the 10 W/230 V LED driver demo board are close to the following calculation results.

4.1 Transformer Parameters

For QR operation, a sufficiently large reflected voltage from the secondary to the primary side present during the flyback time t_f has to be provided. After discharge of the transformer by means of the secondary winding current the energy coupled to the reflected voltage is needed to reduce the input voltage at switch-on instantly in the VDS valley to $V_{dsmin} = V_{in} - V_r$. With the selection of $V_{dsmin} = 0$ a value $V_r = V_{inp}$, where

$$V_{inp} = \sqrt{2}V_{in} \quad (3)$$

is received according to

$$V_r = V_{inp} - V_{ds\ min} \quad (4)$$

The ratio $q = V_r / V_{inp}$ with $q \leq 1$ determines the maximum input voltage V_{inp} to be processed with zero-voltage switching. The winding ratio $r_n = n_p / n_s$ is then calculated as $r_n = 12$.

$$r_n = \frac{V_r}{V_{LED} + V_{do}} \quad (5)$$

The driver operation frequency f varies over the line voltage phase and reaches its maximum values in the line voltage phase close to the voltage peak V_{inp} . Consideration of a QR mode condition defines the primary inductance $L = 6.1\text{ mH}$ (6.3 mH chosen) based on

$$L = \frac{V_{in}^2}{2P_{in}f} \left[1 + \frac{V_{inp}}{V_r} \right]^{-2} \quad (6)$$

With the selection $f = f_{max}$, the equation for the minimum on-time

$$t_{on} = \sqrt{\frac{2LP_{in}}{f}} \frac{1}{V_{in}} \quad (7)$$

yields $t_{on} = 5.0\text{ }\mu\text{s}$ and so the minimum duty cycle becomes $D_{min} = 0.5$ as

$$D_{min} = \frac{\sqrt{2LP_{in}f}}{V_{in}} \quad (8)$$

Now the maximum primary peak current arising in the line phase with $V_{in} = V_{inp}$ can be fixed as $I_{pmaxp} = 0.27$ A according to

$$I_{pmaxp} = 2\sqrt{\frac{Pin}{Lf}} \quad (9)$$

Assuming a saturation inductance of $B_m = 0.4$ T and $A_e = 20.1$ mm² a minimum number of primary turns of $np \approx 200$ ($np = 190$ chosen) would be obtained.

$$np_{min} = \frac{LI_{pmaxp}}{A_e B_m} \quad (10)$$

The maximum magnetic permeance $AL_{max} = 170$ nH is obtained using

$$AL_{max} = \frac{L}{np^2} \quad (11)$$

which determines the air gap using the k -factors in

$$s = \left[\frac{AL_{max} 10^9}{k_1} \right]^{\frac{1}{k_2}} \quad (12)$$

For the often relevant E16-core, the k -factors are $k_1 = 42.2$ and $k_2 = -0.701$ resulting in $s \approx 0.15$ mm. The secondary number of turns is then given by

$$ns = \frac{np}{r_n} \quad (13)$$

By choosing $ns = 14$ and the centered IC supply voltage $V_{cc} = (V_{ccmax} + V_{ccmin}) / 2 = 19$ the auxiliary winding number will be $na = 10$ according to

$$na = ns \frac{V_{ccmax}}{V_{LED} + V_{do}} \quad (14)$$

4.2 Power Switch

The maximum voltage V_{DSmax} along the drain-source path of the MOSFET arises during the line phase with $V_{in} = V_{inp}$ at the instant just subsequent to switching off the primary current. In this phase the high-frequency oscillation amplitude

$$V_{osc} \cong I_{pmaxp} \sqrt{\frac{L_s}{C_{ds}}} \quad (15)$$

adds to the superposition given by the input voltage and reflected voltage to

$$V_{DSmax} = V_{inp} (1 + q) + V_{osc} \quad (16)$$

The V_{DSmax} value can be limited by either reducing the QR effect (with q) at the cost of driver efficiency or by damping the oscillation by means of a snubber circuit. These limiting approaches can be compared in terms of

cost and efficiency reduction with the option of choosing MOSFETs with higher breakdown voltages. For high efficiency it is recommended to make the adjustment $V_{DSmax} = 2 V_{inp} + V_{osc} < 800 \text{ V}$ or 900 V respectively. If necessary, a transformer design with $q < 1$ (meaning reduced QR operation effect) should be favored over high snubber losses.

4.3 Primary Peak Current Control

The peak current charging the primary inductance of the transformer reaches its maximum value at the input voltage V_{inp} . By choosing the maximum threshold $V_{csmax} = 0.75 \text{ V}$ for the shunt voltage generated at the instant of V_{inp} , the shunt resistance is $R_s = 2.7 \Omega$ based on

$$R_s = \frac{V_{cs \max}}{I_{p \max p}} \quad (17)$$

The upper resistor, R_o , in the input voltage divider is dimensioned in consideration of losses and PFC. For efficiency optimization, high ohmic values are preferred. A low ohmic input voltage divider enables a maximum power factor adjustment.

The resistance of the lower input voltage divider resistor is expressed as

$$R_u = \frac{R_o R_s G_{PWM} I_{p \max p}}{V_{inp} - G_{PWM} I_{p \max p} R_s} \quad (18)$$

For the selection $V_{csmax} \approx 0.75 \text{ V}$ and $R_s = 2.7 \Omega$ the R_u equation above helps to define (with the specification of $R_o = 560 \text{ k}\Omega$) a resistance of $R_u = 4.3 \text{ k}\Omega$ (choose $R_u = 3.9 \text{ k}\Omega$).

4.4 Foldback Correction

When the line input voltage increases, the comparator threshold for switching off the power switch is reached in a shorter time and the resulting increase in operation frequency would lead to a strong increase in the LED driver power. To limit the input voltage dependence above a certain limit V_{inth} , the foldback correction reduces the threshold $V_{csmax}(I_{cz})$ in accordance with the current detected at the ZCD pin as expressed here:

$$I_{cz}(V_{in}) = \frac{V_{in} \cdot n_a}{R_{cz1} \cdot n_p} \quad (19)$$

The characteristic curve $V_{csmax}(I_{cz})$ implemented in the IC shows the following steps:

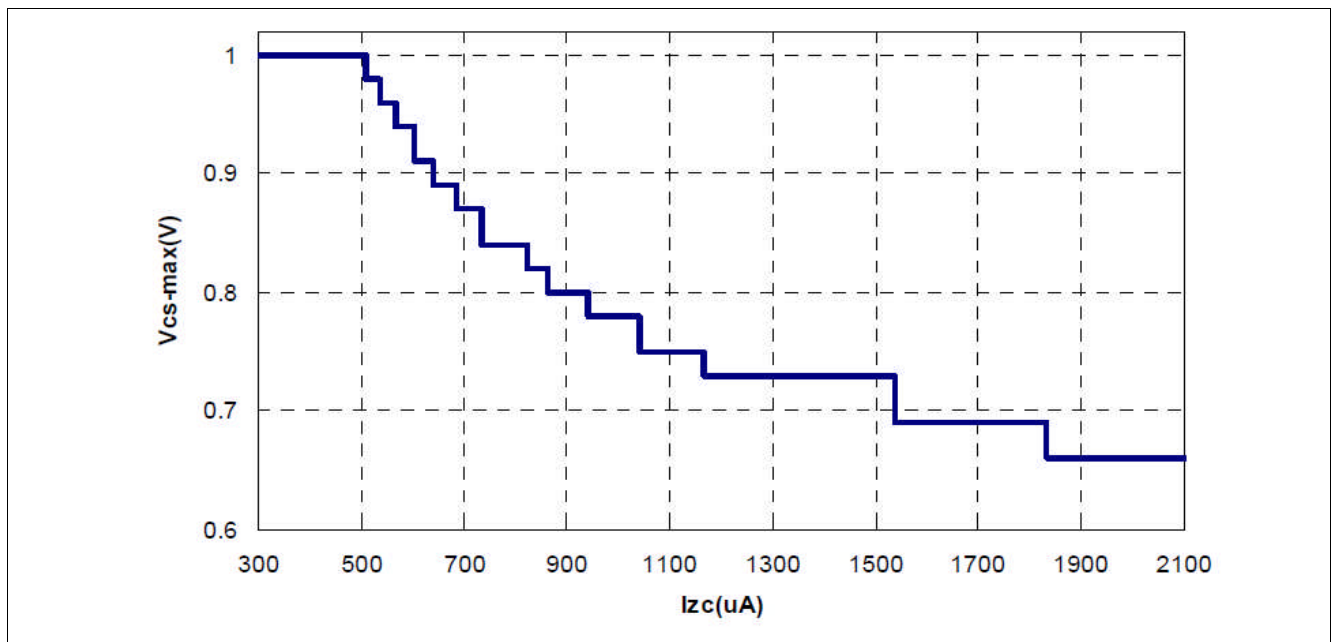

Figure 4 $V_{csmax}(I_{zc})$ characteristic curve

For the adjusted setting $V_{inth} = V_{inp}$ and selection of the foldback operation point $V_{cs-max} = 0.75 \text{ V} / I_{cz} = 1 \text{ mA}$, using the characteristic curve the detection resistance is calculated to be $R_{cz1} \approx 15 \text{ k}\Omega$ according to

$$R_{cz1} = \frac{V_{inth} \cdot n_a}{I_{cz} \cdot n_p} \quad (20)$$

From the characteristic curve it can be seen that the V_{in} dependence of V_{csmax} is stronger in the range of higher threshold values. This means that if a strong impact of the foldback correction is desired, the V_{cs} should reach rather high values at V_{inp} . For increased power constancy under input voltage variations, higher values of R4 and R19 should be chosen.

4.5 Switch-on Determination for Quasi-resonant Operation

For ideal quasi-resonant operation the switch-on of the power switch should occur when the transformer current in the output circuit reaches zero and half of the oscillation period (oscillation 2 in [Figure 5](#)) defined by the leakage inductance and the drain-source capacitance of the power switch has elapsed.

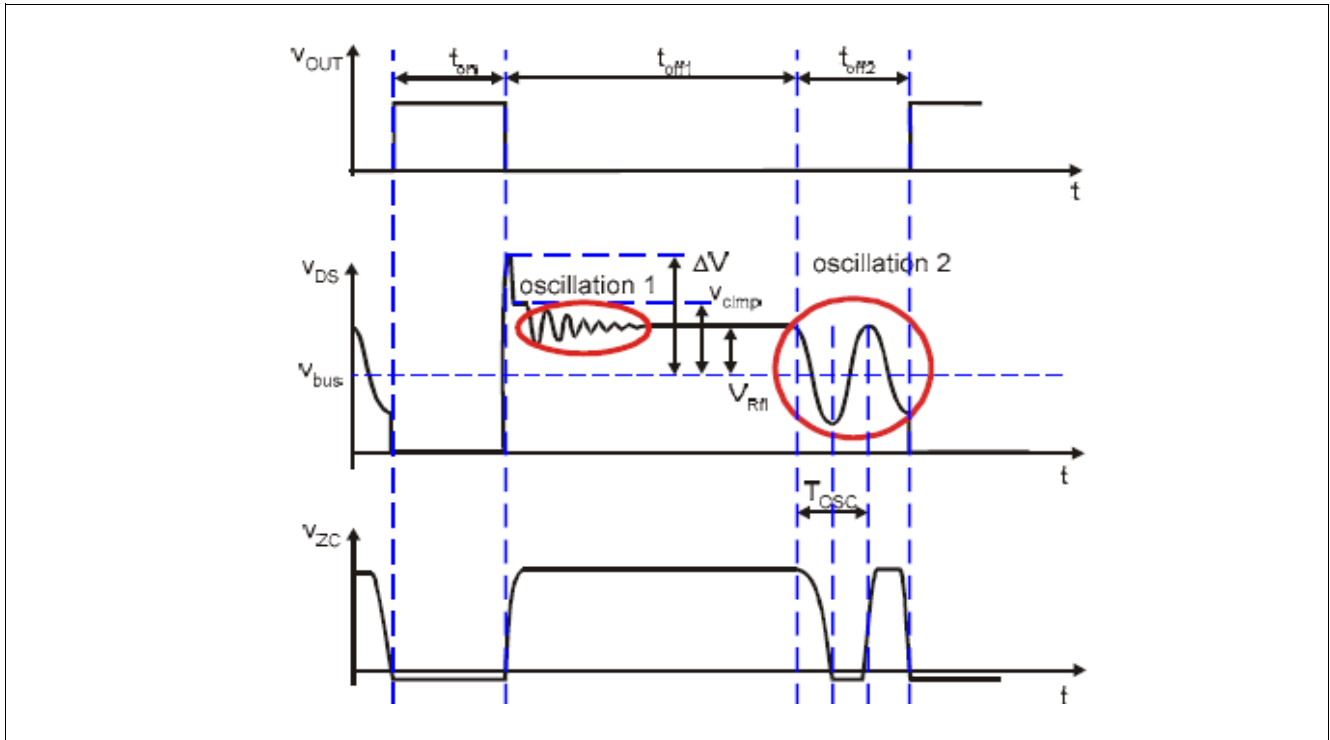

Figure 5 Determination of the switch-on instant

The delay t_d elapses from the instant of discharging the transformer to when the first V_{DS} valley is reached. For initial dimensioning of the delay circuit the relationship

$$t_d \cong \pi \sqrt{LCds} \quad (21)$$

can be used. For the 230 V / 10 W demo board an initial value of $t_d \approx 1 \mu\text{s}$ is appropriate. For output overvoltage protection with final shutdown at $V_o > 45 \text{ V}$ it turns out to be useful to choose $R_{zc2} \approx 2 \text{ k}\Omega$. Consequently, the capacitance of the delay circuit $C_{zc} = 580 \text{ pF}$ (choose $C_{zc} = 470 \text{ pF}$) will be obtained according to

$$C_{zc} \cong t_d \frac{R_{zc1} + R_{zc2}}{R_{zc1}R_{zc2}} \quad (22)$$

5 Design Optimizations

5.1 Dimming

5.1.1 Dimming Principle

The LED driver input voltage at phase cut dimming with the switching instant t_s will generate an effective voltage of $V_{ineff}(t_s)$. From the applied dimming principle it can be seen that the LED power will depend on $V_{ineff}(t_s)$ according to the proportionality law

$$P_{LED}(V_{rms}(t_s)) \approx (V_{rms}(t_s))^x \quad (24)$$

where $1.5 < x < 2.0$. Consequently, the light level depends on the RMS input voltage $V_{rms}(t_s)$ provided by the phase cut dimmer and the dimming range is therefore given by the phase-cut limits of the wall dimmer. For the example of a trailing edge dimmer, the following diagrams show the time dependence of the modified input voltage $V(t, t_s)$ with the fixed parameter switching instant $t_s = T/4$ and the RMS input voltage $V_{rms}(t_s)$ during a theoretical full variation of switching instants t_s for visualization of the mathematical function $V_{rms}(t_s)$.

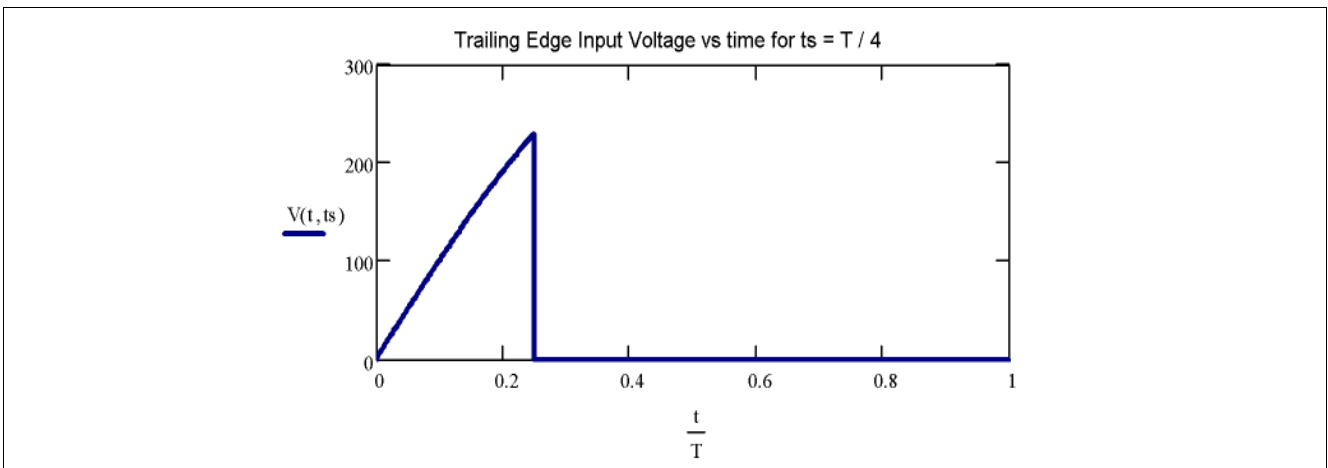

Figure 7 Timing dependency on input voltage

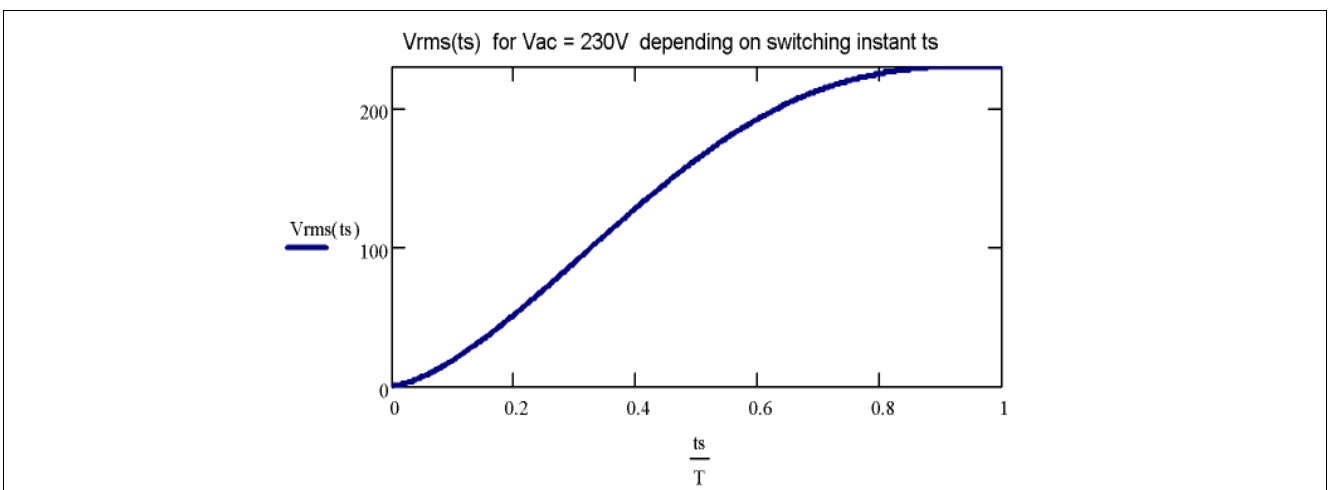

Figure 8 Timing dependency on RMS input voltage

Phase cut dimming arrangement

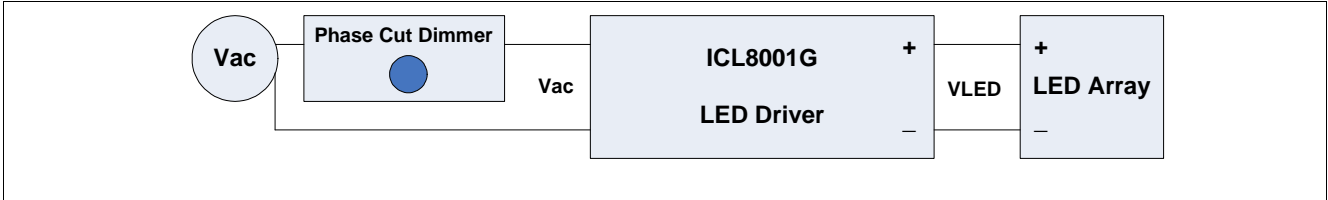

Figure 9 Phase cut dimming arrangement

The experimental dependence PLED(Vrms) is illustrated using a 40 Weq LED bulb driver controlled with a trailing edge phase cut dimmer.

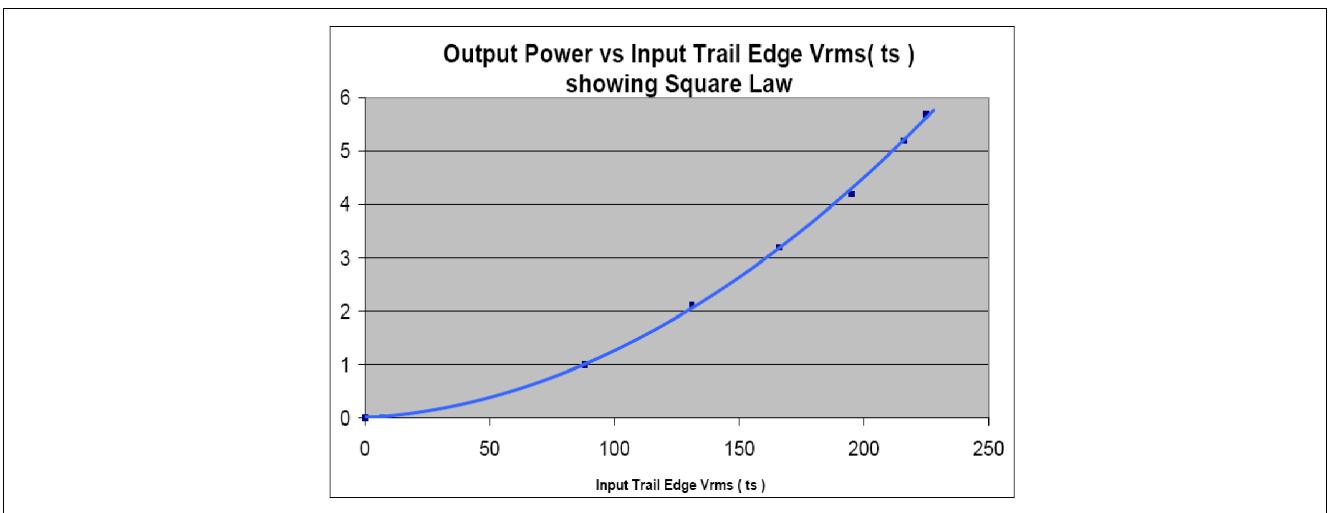

Figure 10 Output power versus input trail edge Vrms

Effective for the application is the dependence of the LED driver power on the switching instant t_s / switching angle. The following experimental diagram obtained with an Ehmann trailing edge dimmer shows the dependence of the switching instant t_s on the driver input power (upper curve) and LED power (lower curve) respectively.

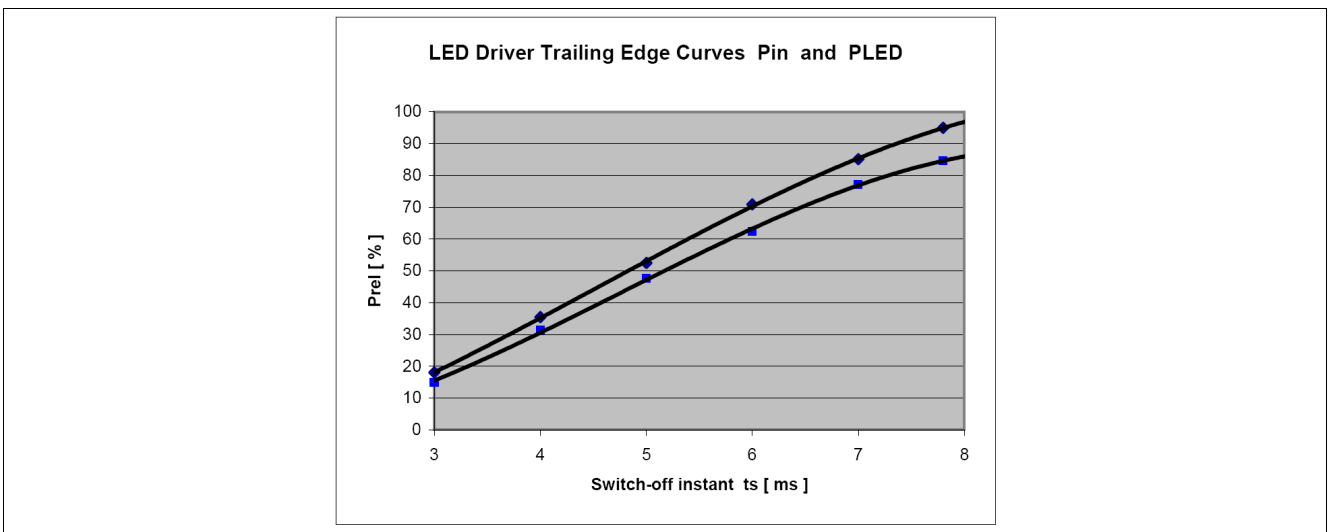

Figure 11 Relationship between switch-off instant t_s and power

The lower curve corresponds closely to the lumen flux of the LED array supplied by the driver and illustrates a continuous increase for the switching angle variation at the wall dimmer.

5.1.2 Dimmer Compatibility

The driver operation with TRIAC dimmers makes it necessary to observe the requirements regarding their hold-up currents. In addition, the steep rising voltage slopes can excite disturbing interactions with the parasitics of the EMI filter of the driver. To dampen these interactions it is useful to implement a low-pass filter close to the EMI filter. As placement of the filter in front of the input rectifier would decrease the EMI filter performance it is recommendable to choose a position parallel to the input voltage divider. In the circuit diagram further below, an R-C circuit is implemented. Dimensioning of $R8 = 220 \Omega$ and $C8 = 68 \text{ nF}$ (not integrated in the standard demo board layout) provides stabilization for leading-edge dimmer operation. The non-dimming driver efficiency is reduced by only typically 1 %.

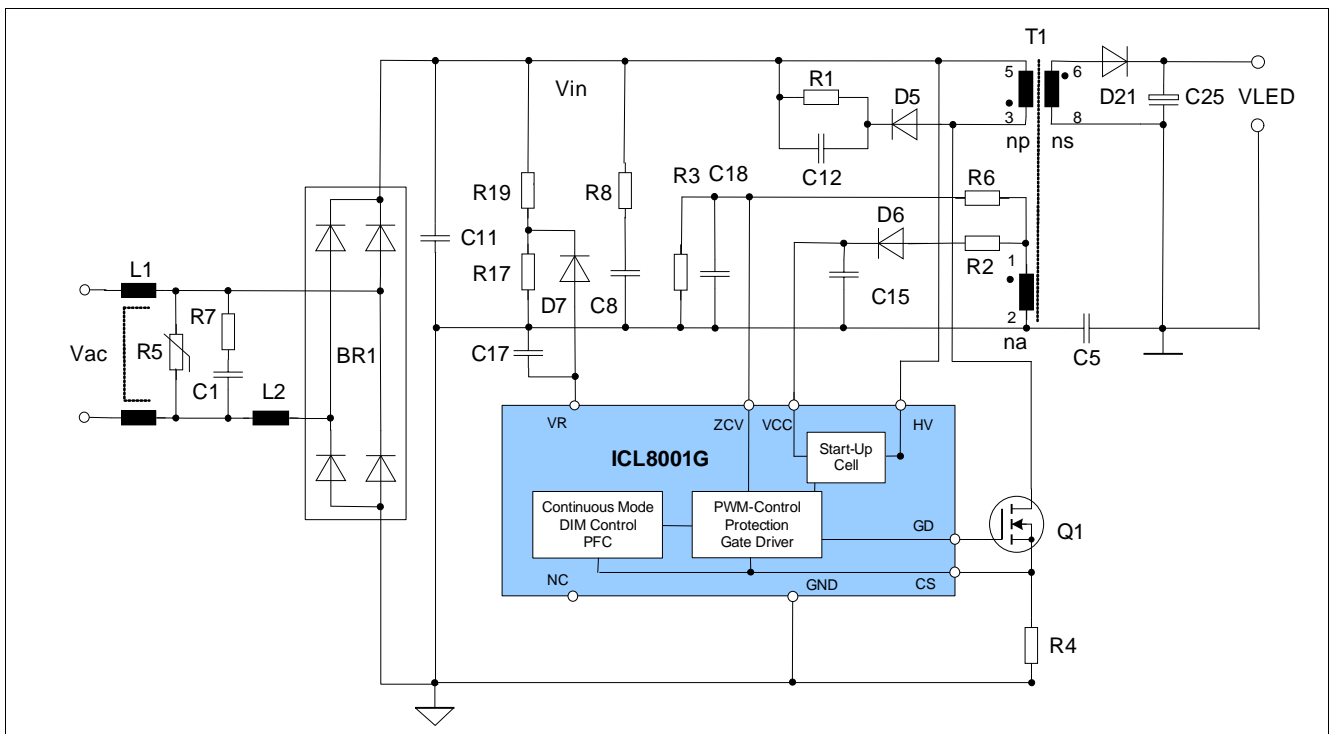

Figure 12 Extended application circuit for dimming

Especially for applications with low input voltage and resulting higher input currents, shaping of the input current waveforms has been shown to be effective in achieving dimming stability. For this, an increase in the ratio $R17 / (R17 + R19)$ and increase in $R4$ for keeping the LED power constant is suggested. The principal modification of the modification on the different waveforms is indicated in [Figure 13](#) below.

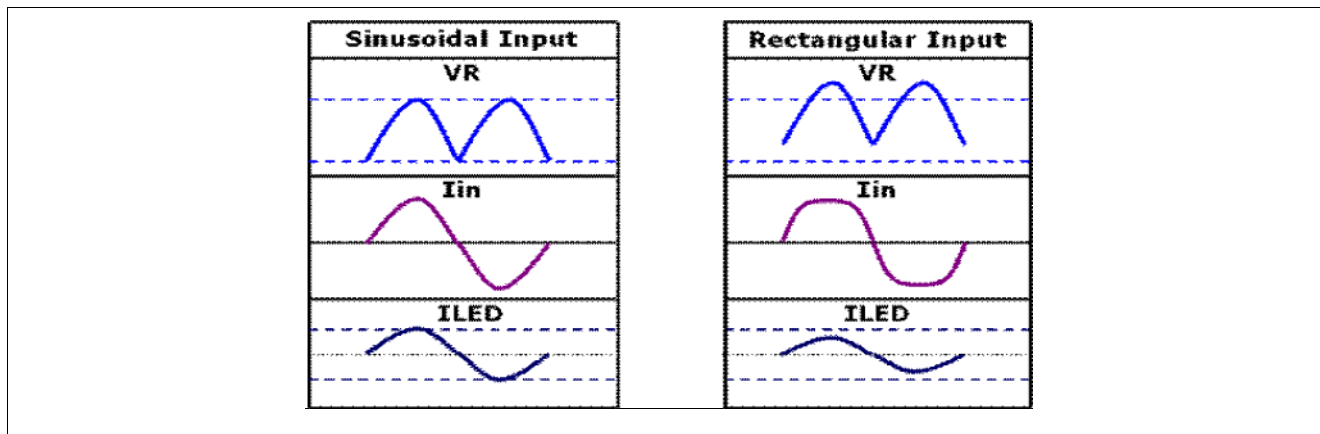

Figure 13 Input current waveforms

For an input supply voltage of 100 V the resistors have been changed accordingly: R19 from 3.9 k Ω to 10 k Ω , R19 from 150 k Ω to 300 k Ω and R4 from 2.2 Ω to 2.7 Ω . The increased dimmer compatibility decreases the power factor from 99 % to 86 %. This modification can be combined with dimensioning for a stronger effect of the foldback correction. Designs with an increased VR voltage level will lead to a reduction in driver efficiency.

5.1.3 Dimmer List

Table 2 Input voltage 230 V / 10 W

Manufacturer	Type/designation	Power limit	Dimming range
PDL	Leading Edge CAT634LM	450 W	20 – 100 %
Busch	Leading Edge 2200	400 W	16 – 100 %
Ehmann	Leading Edge T10	300 W	3 – 100 %
Ehmann	Trailing Edge T46	315 W	23 – 100 %
HPM	Trailing Edge Cat400T	400 W	6 – 100 %
PDL	Trailing Edge CAT624TM	450 W	10 – 100 %

Table 3 Input voltage 100 V / 10 W

Manufacturer	Type/designation	Power limit	Dimming range
LEVITON	Leading Edge decora RPI06	600 W	11 – 100 %
LEVITON	Leading Edge TRIMATRON 6684	600 W	5 – 100 %
LUTRON	Leading Edge SKYLARK S-600H-WH	600 W	3 – 100 %
LUTRON	Leading Edge SKYLARK S-600P	600 W	4 – 100 %
LUTRON	Leading Edge TOGGLER TG-600PH-IV	600 W	9 – 100 %

5.1.4 Dimmer Selection

With ICL8001G / ICLS8082G control the LED driver can be operated without a wall dimmer as well as using trailing- and leading-edge dimmers. With the phase-cut dimmers applied above, a satisfying light quality and variation in the LED lumen flux over the dimming range has been achieved. For both technologies the phase-cut range should be sufficiently large to provide the dimming range required. The dimming range available with a particular dimmer for incandescent lamps is directly transferred to the LED driver with ICL8001G / ICLS8082G, but the lumen output of the LEDs at the minimum dimming position will be higher than with incandescent lamps as they need a high amount of thermal power to enable the visible light radiation process. Particularly for operation with 230 V input voltage, leading-edge wall dimmers with a lower rated power range – and hence lower hold-up current requirements – should be selected in order to prevent the occurrence of repetitive TRIAC ignition. Operation with lower input voltages, such as 110 V, provides a higher input current, which in principle supports more stable TRIAC operation.

Touch dimmers with internal IC control, which depends exclusively on a resistive load for sufficient digital IC supply, should not be selected for LED driver control.

5.2 Power Stabilization for Line Voltage Variations

For stable lumen output and limitation of LED power during mains voltage variations it may be useful to consider power stabilization for the LED driver design. This can be achieved by appropriate use of IC foldback correction without additional external components.

5.2.1 Stabilization using IC Foldback Correction

Driver design can be dimensioned in such a way that PLED variation becomes smaller in the range $V_{in,min} < V_{in} < V_{in,max}$ than would be expected from the approximate quadratic power law. The effect of the foldback correction on LED power and LED current variations can be enhanced by means of an increased R17 value with a constant R19. This will modify the input current waveform from sinusoidal to a more rectangular curve. The LED power can be readjusted by means of the shunt resistor R4. The effect of the foldback correction on the LED power and on LED current variation can be further increased by additionally lowering the Vcs limit. For this second step the R6 value is decreased.

PLED is readjusted using the shunt resistor R4. The R6 value can be decreased until the latch-off threshold of the output overvoltage detection is reached. The principal experimental LED current increase for a 10 % input voltage increase is shown in the following diagram. For input voltage drops, similar behavior is obtained for the LED current decrease.

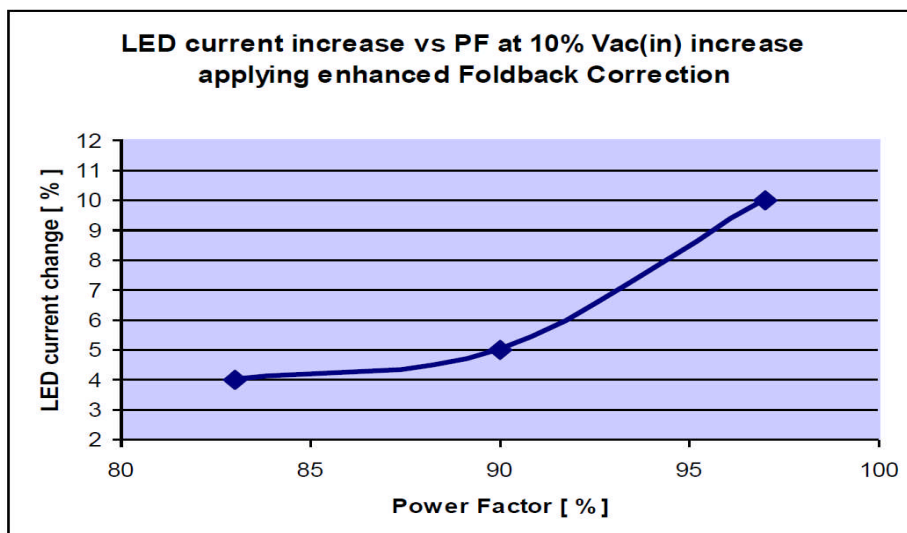

Figure 14 LED current behavior according to power factor using foldback correction

The table below shows the relevant design parameters. Consideration of EMI and driver efficiency designs with PF > 90 % are recommended.

Table 4 Design parameters for stabilization using foldback correction

R17	R19	R6	R4	Pin, rel [%]	ILEDrel, dec [%]	ILEDrel, inc [%]
10k	560k	10k	3R3	4.9	3.8	4
10k	560k	6k8	3R3	6	5	5
3k9	560k	10k	2R7	12	11.6	10

The LED driver should be designed for operation at the maximum voltage arising in the input voltage range.

5.2.2 Discrete Power Stabilization Circuit for ICL8001G

For especially high requirements regarding input power or LED current stability for line voltage variations, such as $\Delta I_{LED} \leq \pm 2\%$ at $\Delta V_{ac} = \pm 10\%$, and for low harmonic distortion, a solution using a discrete differential amplifier can be proposed. Here the V_{in} signal is sensed by means of a voltage divider consisting of R21 and R22, and smoothed by C21. The Zener diode D21 is used for the reference voltage. When the smoothed voltage is much smaller than the reference voltage, the current through R23 will flow only through R24 and there is no influence on the output power of the demo board. When the value of the smoothed voltage is near the reference voltage, part of the current flowing through R23 will begin flowing through R25, R26 and R4 to GND to generate an additional voltage drop. Subsequently, its waveform shows the same slope at pin CS as the rectified input voltage $V_{in}(t)$.

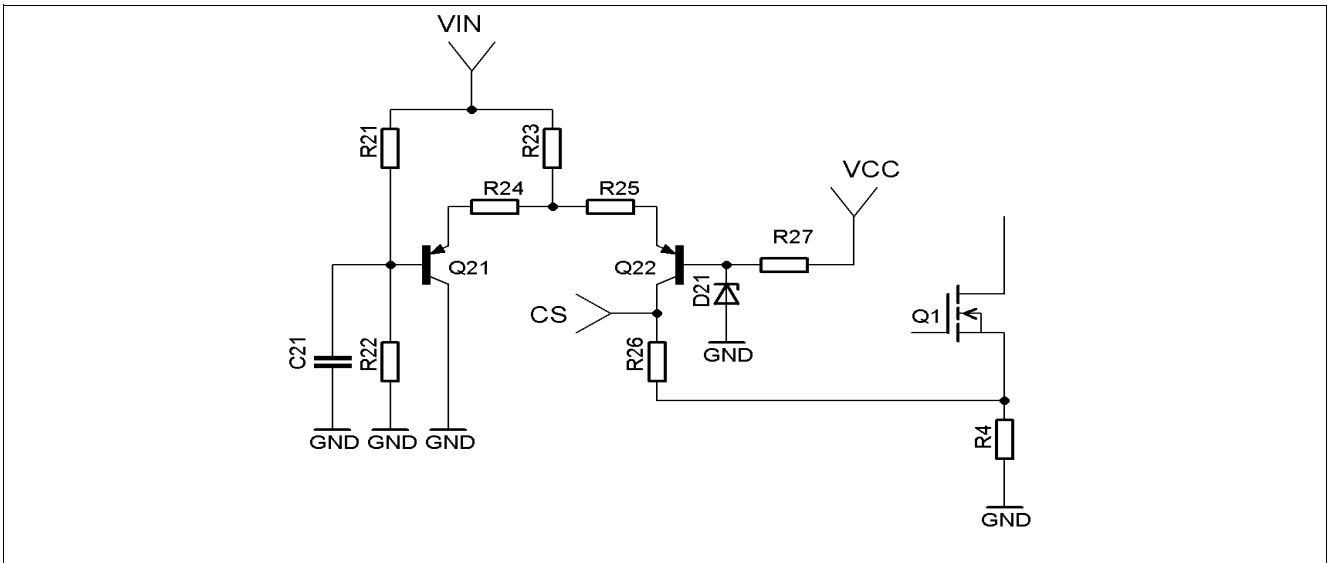

Figure 15 Discrete power stabilization circuit

As the on-time of the power MOSFET Q1 is reduced the LED driver power is also reduced. The parameters should be adjusted so that the smoothed voltage at the base of Q21 is equal to the reference voltage at the base of Q22 at the nominal input voltage. The maximal additional voltage drop on the CS pin should be approximately 10 % to 20 % of the original CS limit at the maximum input voltage. As the waveform of the additional voltage drop at the CS pin has the same slope as $V_{in}(t)$, the input current will not change significantly, but still enable designs with a high power factor and low harmonic distortion. Careful optimization of the discrete stabilization circuit containing the components stated in the BOM below when connected to the 230 V / 10 W driver delivers variations of $\Delta I_{LED} \leq +0.3\%$ and $\Delta I_{LED} \leq -1.3\%$ at $\Delta V_{ac} = +10\%$ and $\Delta V_{ac} = -10\%$ respectively. There is no influence on output short circuit and output open loop detection.

BOM of Discrete Power Stabilization Circuit for 230V / 10W ICL8001G LED Driver Demoboard		
Component	Value	Package
Q21	BC860B (PNP)	SOT23
Q22	BC860B (PNP)	SOT23
C21	470nF/50V	0805
R21	2.2M Ω	0805
R22	75k Ω	0805
R23	1M Ω	0805
R24	10k	0805
R25	10k	0805
R26	1k5	0805
R27	68k	0805
D21	ZMM6V8	Minimelf

Figure 16 Bill of Materials (BOM) for power stabilization circuit

5.3 Optimized Power Factor Correction Performance

Driver optimization for high power factor correction can deliver very high PF > 99 % and THD ≈ 10 %. Corresponding measurements for a 100 V / 10 W LED driver result in the timing diagrams for the setpoint voltage VR(t) and driver input current Iin(t).

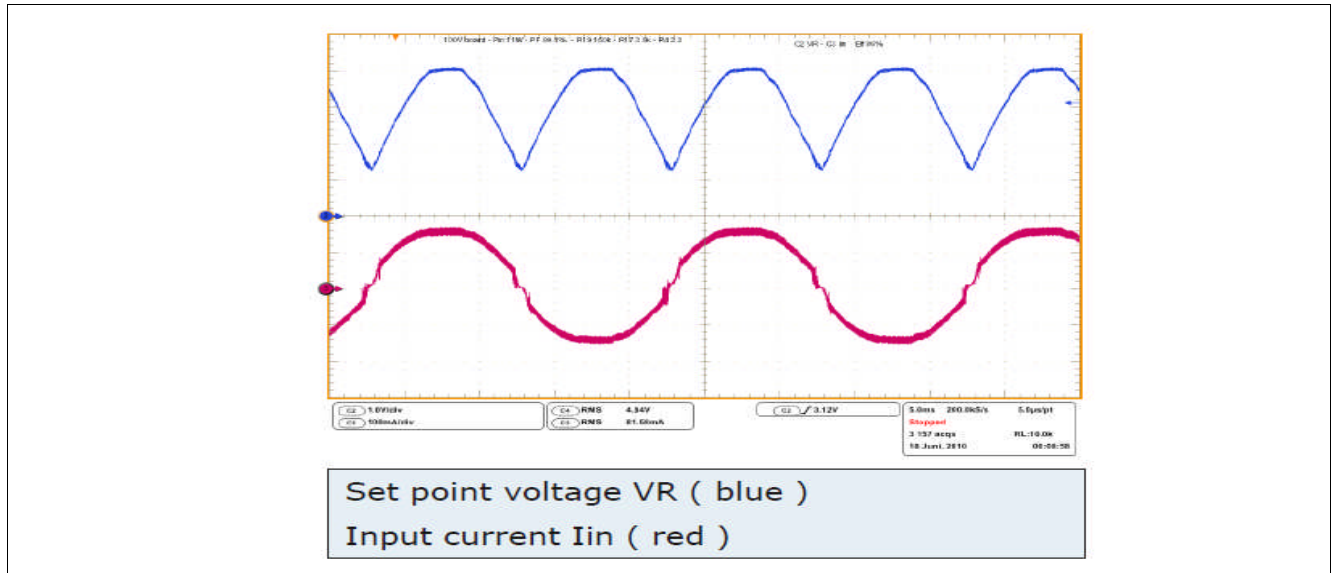

Figure 17 Optimized power factor correction

Dimmable QR LED Driver Board BOM for ICL8001G – Primary Control 100V / 10W / high PF & Efficiency		
Component	Value	Package
U1	ICL8001G	P-DSO-8
BR	RMB6S	SMD
D5	not assembled	fast, 1.5A, MELF-B
D6	LL4148	Mini-MELF
D7	LL4148	Mini-MELF
D21	60V, 2A, Schottky Diode	SMB
Q1	SPD02N80C3	D-PAK
C1	68nF/250VAC MKP-X2	RM10
C5	1n/250VAC-Y1	RM10
C8	not assembled	
C11	33nF / 630V	RM15 EPCOS B32529/520/521/522
C12	not assembled	RM7.5
C15	22uF+10uF / 25V	1210
C17	2.2nF / 25V	0805
C18	470pF / 25V	0805
C22, C24	not assembled	1206
C25	220uF / 35V / Elko	RM 5, diameter 10, height 12
L1	2x15mH / 0.4A	B82730 U3401A 020
L2	1mH / 130mA	axial / EPCOS B78108S1105J
T1	EF16/9 - L35 = 4.0mH	Würth 750813141 N35 = 190 / N68 = 14 / N12 = 10
R1	not assembled	axial
R2	22R0	0805
R3	2k0	0805
R4	2R2	1206
R5	Varistor / 275Vac	RM10 EPCOS S10K275
R6	15k	0805
R7	0R0	axial
R8	not assembled	
R17	3k9	0805
R19	150k	0805

Figure 18 Bill of Materials (BOM) for 100 V / 10 W LED driver with high PF

6 Protection Functions

The following ICL8001G / ICLS8082G protection functions are provided.

Table 5 ICL8001G / ICLS8082G protection functions

VCC Overvoltage	Auto Restart Mode
VCC Undervoltage	Auto Restart Mode
Output Overvoltage	Latched Off Mode
Output Short Circuit	Auto Restart Mode
Short Winding	Latched Off Mode
Over temperature	Auto Restart Mode

6.1 Output OVP

By means of VCC overvoltage detection it is possible to switch to Auto Restart Mode, which causes a blinking effect of the LED. The output voltage threshold V_{oovp_vcc} can be adjusted by means of the resistor R_{vcc} in the VCC supply circuit.

A second output overvoltage threshold V_{oovpth} can be adjusted to set Latched Off Mode using the IC threshold $V_{zcovp} = 3.7$ V. For a decreased output OV threshold $V_{oovpth} = 35$ V the R_{zc2} resistance value is increased to $R_{zc2} = 2.7$ k Ω based on the equation

$$R_{zc2} = \frac{ns R_{zc1} V_{zcovp}}{na V_{oovpth} - ns V_{zcovp}} \quad (25)$$

6.2 Output Short Circuit Protection

In the case of an output short circuit, the IC will switch to Auto Restart Mode by means of VCC undervoltage detection. No special dimensioning is required for this purpose.

6.3 Input Overvoltage Protection (OVP)

Upon input overvoltage the foldback point correction becomes active and limits the LED driver input power at the thresholds stated above.

7 Explicit Questions and Answers

7.1 Application

What are the main applications of ICL8001G / ICLS8082G Control?

ICL8001G / ICLS8082G is optimized for offline LED lighting like dimmable LED bulbs for incandescent lamp replacement, LED downlights and LED tubes. The PFC function enables a power range of typically 5 W to 50 W to be applied.

Should LED drivers for universal input voltage be designed?

Universal input designs lead to essential efficiency reduction in the LED driver and are therefore not supported by special IC features.

Is it possible to supply different LED modules with strong variations in total forward voltages?

The LED driver requirements under strongly varying conditions of phase-cut dimming are tough. The VCC concept compatible with these requirements and proposed here does not allow for strong variations in the DC output voltage but only for limited output voltage variation. Only in this case is a constant transformer winding ratio or a design with single transformer connecting points at the auxiliary winding sufficient.

How can driver efficiencies exceeding 90 % be realized?

Generally at higher power applications with $p_{in} \approx 15$ W, driver efficiencies $> 90\%$ can be realized using optimized QR control with ICL8001G / ICLS8082G.

Can we disable the dimming function and use it as a constant current LED driver with a good power factor?

TDA 4863-2 is recommended for this kind of application. For details, see the Application Note AN186.

What will happen under no-load conditions?

The application circuits based on ICL8001G / ICLS8082G are designed to work with LEDs only. Under no-load conditions it will go to either the auto restart mode due to Vcc OVP or latched off mode due to output OVP.

7.2 Control Principle

How does ICL8001G / ICLS8082G realize dimming control and power factor correction?

Both dimming control and PFC are achieved with the input mains voltage sensing at the VR pin. This signal is used to set the peak current of the primary winding and consequently allows both PFC and phase-cut dimming functionality by regulating the cycle energy.

What are the effects of constant power control compared to constant current?

Under constant power control, variations in the LED forward voltage may cause certain variations in the lumen output while, in contrast, the output remains approximately unchanged under constant LED current control. However, the power control concept also enables the LEDs to be operated thermally under stable conditions. Combination of output power control with power stabilization under input voltage variation as proposed above makes it possible to optimize the heat sink design of an LED bulb or LED lighting fixture and hence minimize system costs.

How does the ICL8001G / ICLS8082G achieve the regulation of the current through the LEDs?

ICL8001G / ICLS8082G controls the cycle energy stored in the primary inductance of the flyback transformer. When also considering the frequency behavior, the resulting LED power depends on quite a few parameters. The influence of input voltage variation can be reduced with the design means described above. The tolerances of the

current sense resistor R4, the voltage dividers formed by R17 and R19 as well as R6 & R3 have also to be considered. The ICL8001G / ICLS8082G PWM parameter GPWM and offset voltage needed for low driver tolerances possess especially high precision, as stated in the ICL8001G / ICLS8082G data sheet.

8 References

[Data Sheet ICL8001G / ICLS8082G](#)

[AN EVAL-LED-ICL8001G-Bulb02 for LED Drivers 230 V / 10 W](#)

[AN EVAL-LED-ICL8082G-Bulb01 for LED Drivers 230 V / 10 W](#)

[AN186 – 40 W LED Street and Indoor Lighting Reference Design](#)

www.infineon.com

Published by Infineon Technologies AG