

## Digital Transistors (Built-in Resistors)

DIGITAL TRANSISTOR (PNP)

**MARKING:** 13

### FEATURES

- Built-in bias resistors enable the configuration of an inverter circuit without connecting external input resistors(see equivalent circuit)
- The bias resistors consist of thin-film resistors with complete isolation to allow positive biasing of the input.They also have the advantage of almost completely eliminating parasitic effects
- Only the on/off conditions need to be set for operation, making device design easy

### • Equivalent Circuit

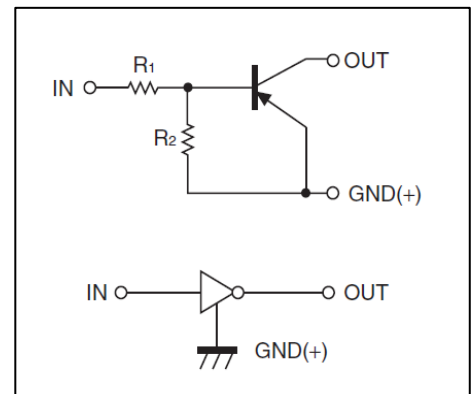

### PIN CONNENCTIONS and MARKING

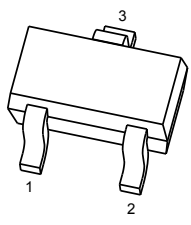
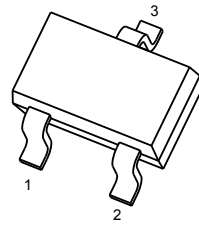
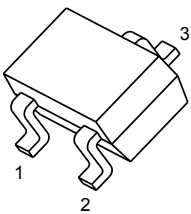
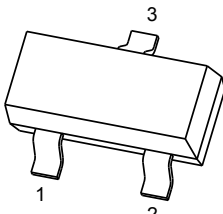
<p><b>DTA143EE</b></p>  <p><b>SOT-523</b></p> <p>1. IN 2. GND 3. OUT</p>	<p><b>DTA143EUA</b></p>  <p><b>SOT-323</b></p> <p>1. IN 2. GND 3. OUT</p>
<p><b>DTA143EKA</b></p>  <p><b>SOT-23-3L</b></p> <p>1. IN 2. GND 3. OUT</p>	<p><b>DTA143ECA</b></p>  <p><b>SOT-23</b></p> <p>1. IN 2. GND 3. OUT</p>

## MAXIMUM RATINGS(Ta=25°C unless otherwise noted)

Symbol	Parameter	Limits(DTA143E□)				Unit
		E	UA	KA	CA	
V <sub>CC</sub>	Supply Voltage	-50				V
V <sub>IN</sub>	Input Voltage	-30~+10				V
I <sub>O</sub>	Output Current	-100				mA
P <sub>D</sub>	Power Dissipation	150	200	200	200	mW
T <sub>J</sub>	Junction Temperature	150				°C
T <sub>stg</sub>	Storage Temperature	-55~+150				°C

## ELECTRICAL CHARACTERISTICS (Ta=25°C unless otherwise specified)

Parameter	Symbol	Conditions	Min	Typ	Max	Unit
Input voltage	V <sub>I(off)</sub>	V <sub>CC</sub> =-5V, I <sub>O</sub> =-100μA	-0.5			V
	V <sub>I(on)</sub>	V <sub>O</sub> =-0.3V, I <sub>O</sub> =-20 mA			-3	V
Output voltage	V <sub>O(on)</sub>	I <sub>O</sub> /I <sub>I</sub> =-10mA/-0.5mA			-0.3	V
Input current	I <sub>I</sub>	V <sub>I</sub> =-5V			-1.8	mA
Output current	I <sub>O(off)</sub>	V <sub>CC</sub> =-50V, V <sub>I</sub> =0			-0.5	μA
DC current gain	G <sub>I</sub>	V <sub>O</sub> =-5V, I <sub>O</sub> =-10mA	30			
Input resistance	R <sub>1</sub>		3.29	4.7	6.11	kΩ
Resistance ratio	R <sub>2</sub> /R <sub>1</sub>		0.8	1	1.2	
Transition frequency	f <sub>T</sub>	V <sub>O</sub> =-10V, I <sub>O</sub> =-5mA, f=100MHz		250		MHz

## Typical Characteristics

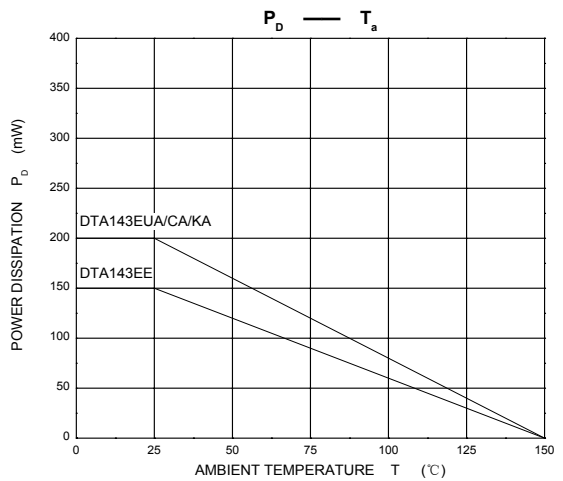
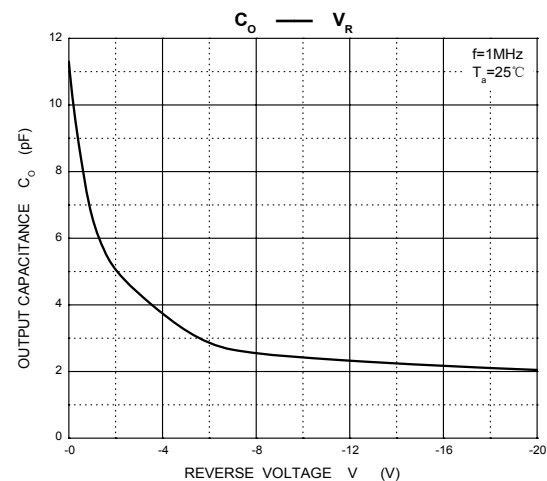
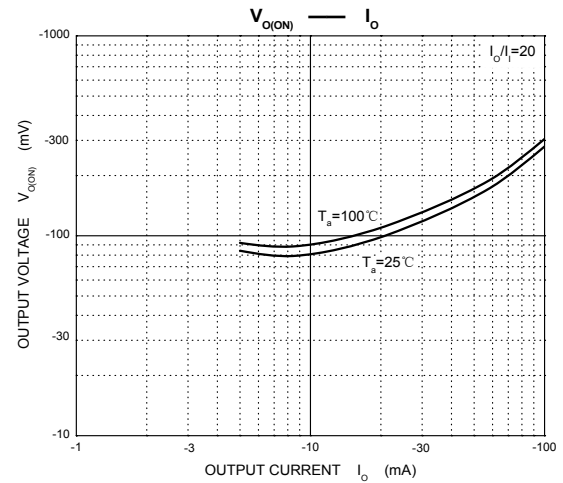
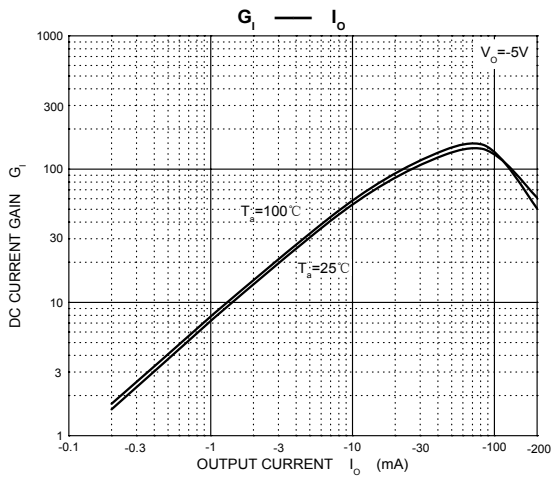
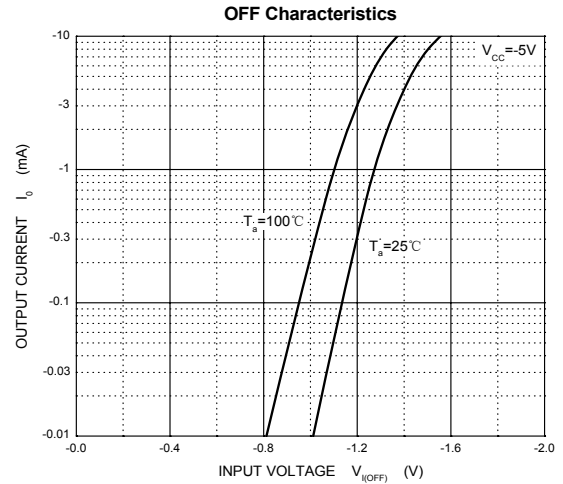
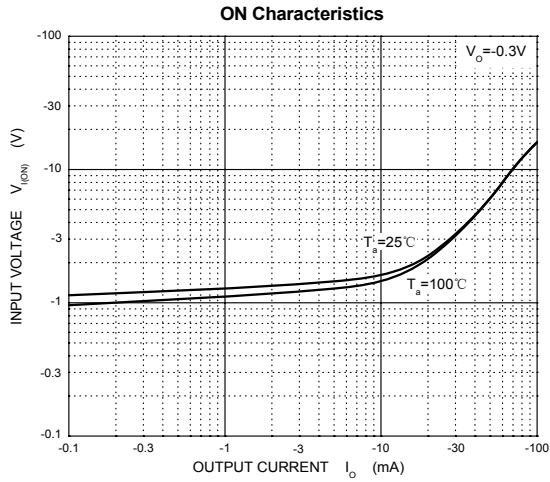

## PACKAGE OUTLINE

Plastic surface mounted package; 3 leads

SOT-523

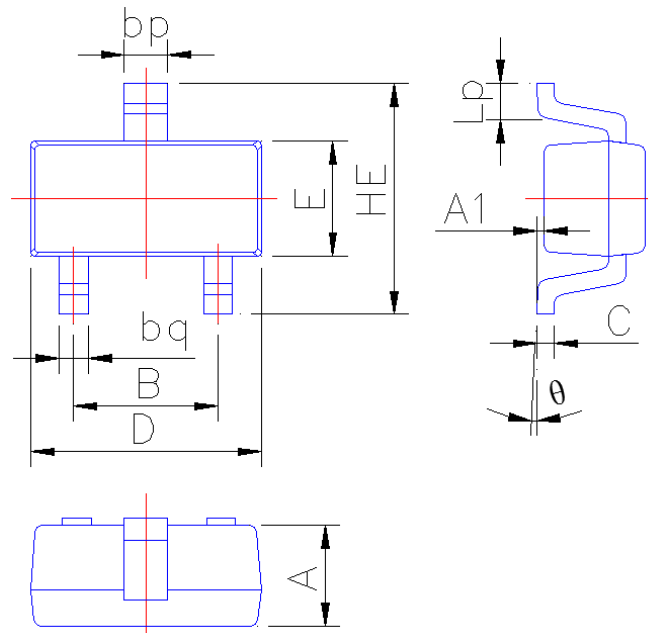

Symbol	Dimension in Millimeters	
	Min	Max
A	0.60	0.80
A1	0.010	0.100
B	0.95	1.05
bp	0.26	0.40
bq	0.16	0.30
C	0.09	0.15
D	1.50	1.70
E	0.70	0.85
HE	1.45	1.75
Lp	0.16	0.36
θ	0°	5°

## SOT-323 Package Outline Dimensions

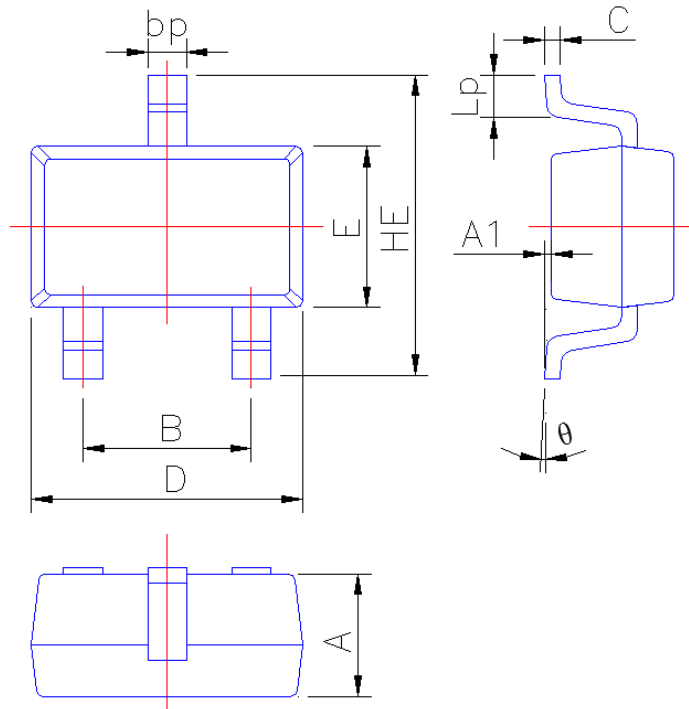

Symbol	Dimension in Millimeters	
	Min	Max
A	0.90	1.00
A1	0.010	0.100
B	1.20	1.40
bp	0.25	0.45
C	0.09	0.15
D	2.00	2.20
E	1.15	1.35
HE	2.15	2.55
Lp	0.25	0.46
$\theta$	0°	6°

## SOT-23-3L Package Outline Dimensions

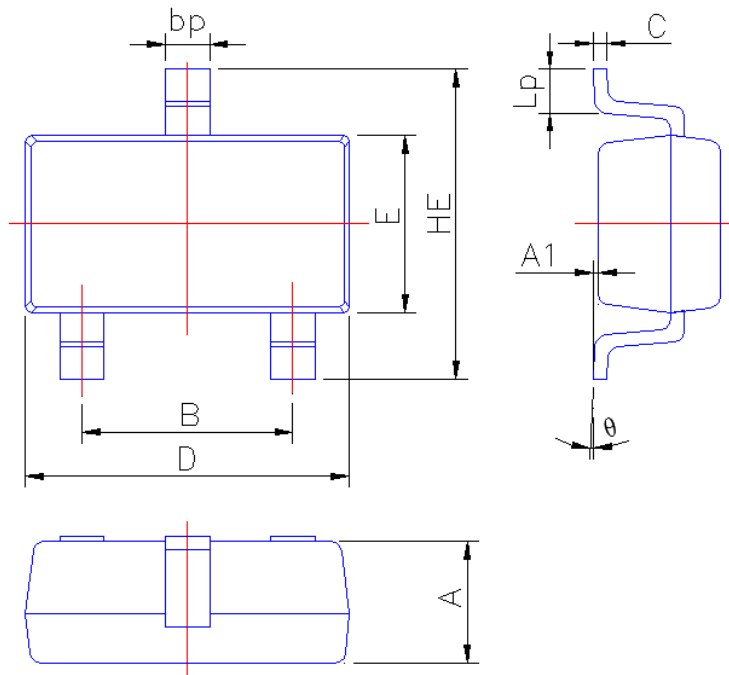

Symbol	Dimension in Millimeters	
	Min	Max
A	1.05	1.20
A1	0.010	0.100
B	1.80	2.00
bp	0.35	0.50
C	0.09	0.15
D	2.80	3.00
E	1.50	1.70
HE	2.60	3.00
Lp	0.25	0.55
θ	2°	6°

## PACKAGE OUTLINE

Plastic surface mounted package; 3 leads

SOT-23

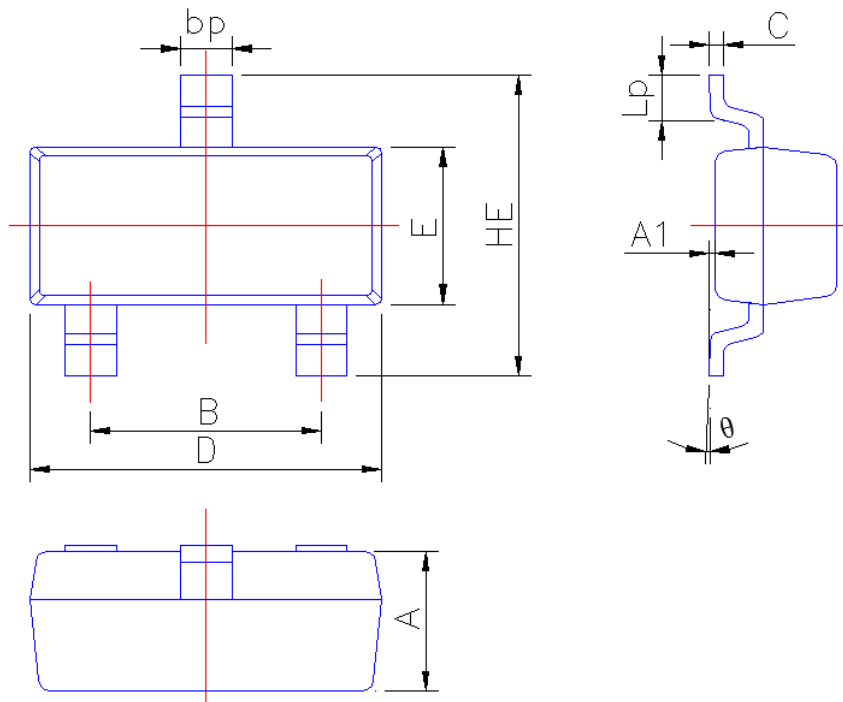

Symbol	Dimension in Millimeters	
	Min	Max
A	0.90	1.10
A1	0.013	0.100
B	1.80	2.00
bp	0.35	0.50
C	0.09	0.150
D	2.80	3.00
E	1.20	1.40
HE	2.20	2.80
Lp	0.20	0.50
theta	0°	5°