

IXYK220N65A5

650 V, 220 A Gen5 XPT™ IGBT

Extreme Light Punch Through IGBT for up to 5 kHz Switching

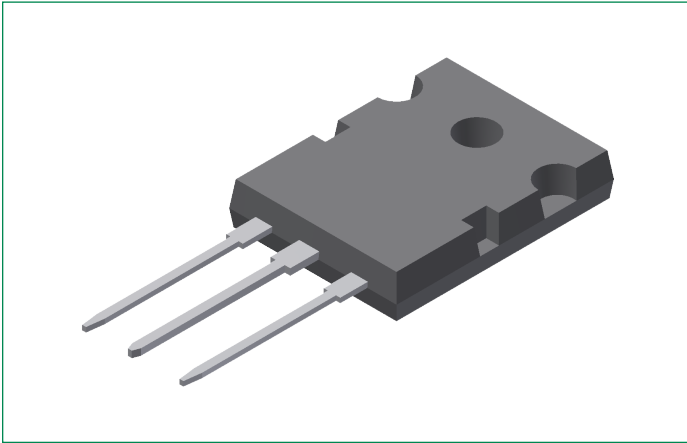

Pinout Diagram TO-264 (IXYK)

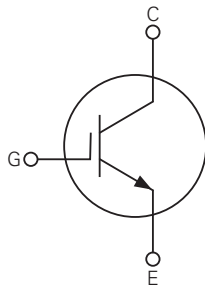
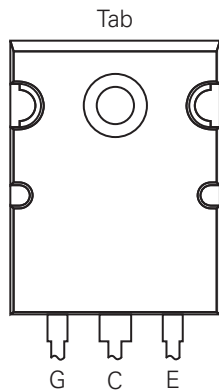

G: Gate; **C:** Collector; **E:** Emitter; **Tab:** Collector

Description:

Developed using our proprietary XPT™ thin-wafer technology and state-of-the-art Trench IGBT process, these devices feature reduced thermal resistance, low conduction losses, and low gate driver requirements.

Features & Benefits:

- Optimized for Low Conduction Losses
- High Surge Current Capability
- Square RBSOA
- International Standard Package
- Low Gate Charge Q_G
- Low Gate Drive Requirement

Applications:

- Power Inverters
- UPS
- PFC Circuits
- Battery Chargers
- Welding Machines
- Lamp Ballasts
- Inrush Current Protection Circuits

Product Summary

Characteristic	Value	Unit
V_{CES}	650	V
I_{C110}	220	A
$V_{CE(sat)}$	1.35	V
$t_{fi(typ)}$	225	ns

Maximum Ratings

Symbol	Characteristic	Conditions	Value	Unit
V_{CES}	Collector-Emitter Voltage	$T_J = 25\text{ °C to }175\text{ °C}$	650	V
V_{CGR}	Collector-Gate Voltage	$T_J = 25\text{ °C to }175\text{ °C}, R_{GE} = 1\text{ M}\Omega$	650	V
V_{GES}	Gate-Emitter Voltage	Continuous	± 20	V
V_{GEM}	Transient Gate-Emitter Voltage	Transient	± 30	V
I_{C25}	Continuous Collector Current	$T_C = 25\text{ °C (Chip Capability)}$	510	A
I_{LRMS}	Terminal Current Limit	–	160	A
I_{C110}	Continuous Collector Current	$T_C = 110\text{ °C}$	220	A
I_{CM}	Pulsed Collector Current	$T_C = 25\text{ °C}, 1\text{ ms}$	1180	A
SSOA (RBSOA)	Switching Safe Operating Area (Reverse Biased Safe Operating Area)	$V_{GE} = 15\text{ V}, T_{VJ} = 150\text{ °C}, R_G = 3\ \Omega,$ Clamped Inductive Load, $I_{CM} = V_{CE} \leq V_{CES}$	300	A
P_C	Collector Power Dissipation	$T_C = 25\text{ °C}$	1610	W
T_J	Junction Temperature	–	–55 to 175	°C
T_{JM}	Maximum Junction Temperature	–	175	°C
T_{stg}	Storage Temperature	–	–55 to 175	°C
T_L	Maximum Lead Temperature for Soldering	1.6 mm (0.062 in.) from Case for 10 s	300	°C
M_d	Mounting Torque	–	1.13 / 10	Nm/lb.in
W	Weight	–	10	g

Thermal Characteristics

Symbol	Characteristic	Value			Unit
		Min.	Typ.	Max.	
$R_{th, JC}$	Thermal Resistance, Junction-to-Case	–	–	0.093	°C/W
$R_{th, CS}$	Thermal Resistance, Case-to-Heatsink	–	0.15	–	°C/W

Electrical Characteristics – Static ($T_J = 25\text{ °C}$ unless otherwise specified)

Symbol	Characteristic	Conditions	Value			Unit
			Min.	Typ.	Max.	
BV_{CES}	Collector-Emitter Breakdown Voltage	$I_C = 250\ \mu\text{A}, V_{GE} = 0\text{ V}$	650	–	–	V
$V_{GE(th)}$	Gate-Emitter Threshold Voltage	$I_C = 4\text{ mA}, V_{CE} = V_{GE}$	3.8	–	5.8	V
I_{GES}	Gate-Emitter Leakage Current	$V_{CE} = 0\text{ V}, V_{GE} = \pm 20\text{ V}$	–	–	± 100	nA
I_{CES}	Zero Gate Voltage Collector Current	$V_{CE} = V_{CES}, V_{GE} = 0\text{ V}$	–	–	25	μA
		$V_{CE} = V_{CES}, V_{GE} = 0\text{ V}, T_J = 150\text{ °C}$	–	–	2	mA
$V_{CE(sat)}$	Collector-Emitter Saturation Voltage ¹	$I_C = 100\text{ A}, V_{GE} = 15\text{ V}$	–	1.15	1.35	V
		$I_C = 100\text{ A}, V_{GE} = 15\text{ V}, T_J = 150\text{ °C}$	–	1.15	–	V

Note 1: Pulse test, $t \leq 300\ \mu\text{s}$, duty cycle, $d \leq 2\%$

Electrical Characteristics – Dynamic ($T_J = 25\text{ °C}$ unless otherwise specified)

Symbol	Characteristic	Conditions	Value			Unit	
			Min.	Typ.	Max.		
g_{fs}	Transconductance ¹	$I_C = 60\text{ A}, V_{CE} = 10\text{ V}$	72	120	–	S	
C_{ies}	Input Capacitance	$V_{GE} = 0\text{ V}, V_{CE} = 25\text{ V}, f = 1\text{ MHz}$	–	11.7	–	pF	
C_{oes}	Output Capacitance		–	570	–		
C_{res}	Reverse Transfer Capacitance		–	440	–		
$Q_{g(on)}$	Total Gate Charge	$V_{GE} = 15\text{ V}, V_{CE} = 0.5 \times V_{CES},$ $I_C = 220\text{ A}$	–	750	–	nC	
Q_{ge}	Gate-Emitter Charge		–	86	–		
Q_{gc}	Gate-Collector Charge		–	377	–		
$t_{d(on)}$	Turn-on Delay Time ²	Inductive Load, $V_{GE} = 15\text{ V}, V_{CE} = 300\text{ V},$ $I_C = 100\text{ A}, R_{G(ext)} = 1\ \Omega$	$T_J = 25\text{ °C}$	–	64	–	ns
			$T_J = 150\text{ °C}$	–	50	–	
t_{ri}	Turn-on Rise Time ²		$T_J = 25\text{ °C}$	–	78	–	ns
			$T_J = 150\text{ °C}$	–	70	–	
E_{on}	Turn-on Energy ²		$T_J = 25\text{ °C}$	–	1.30	–	mJ
			$T_J = 150\text{ °C}$	–	2.75	–	
$t_{d(off)}$	Turn-off Delay Time ²		$T_J = 25\text{ °C}$	–	540	–	ns
			$T_J = 150\text{ °C}$	–	480	–	
t_{fi}	Turn-off Fall Time ²		$T_J = 25\text{ °C}$	–	225	–	ns
			$T_J = 150\text{ °C}$	–	385	–	
E_{off}	Turn-off Energy ²	$T_J = 25\text{ °C}$	–	7.95	–	mJ	
		$T_J = 150\text{ °C}$	–	10.35	–		

Note 1: Pulse test, $t \leq 300\ \mu\text{s}$, duty cycle, $d \leq 2\%$

Note 2: Switching times and energy losses may increase for higher $V_{CE(clamp)}$, T_J , or R_G .

Characteristic Curves

Fig. 1. Output Characteristics @ $T_J = 25\text{ }^\circ\text{C}$

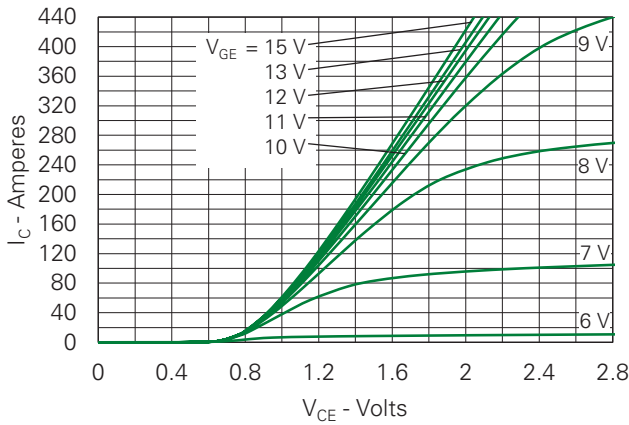

Fig. 2. Extended Output Characteristics @ $T_J = 25\text{ }^\circ\text{C}$

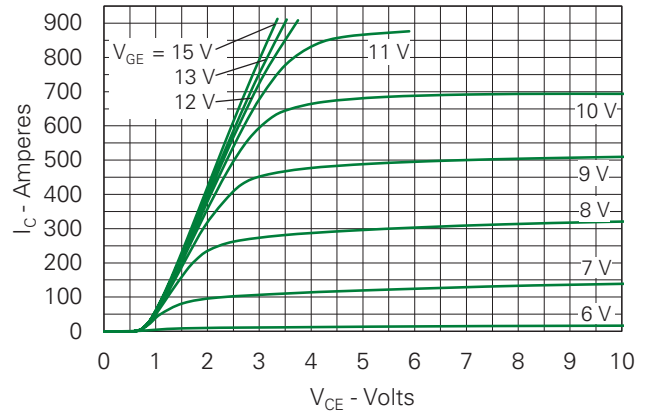

Fig. 3. Output Characteristics @ $T_J = 150\text{ }^\circ\text{C}$

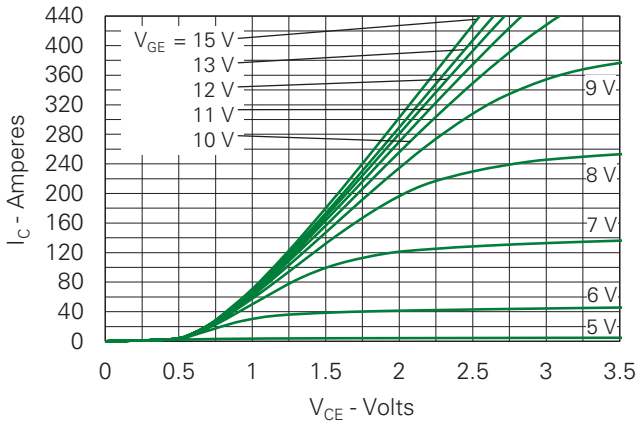

Fig. 4. Dependence of $V_{CE(sat)}$ on Junction Temperature

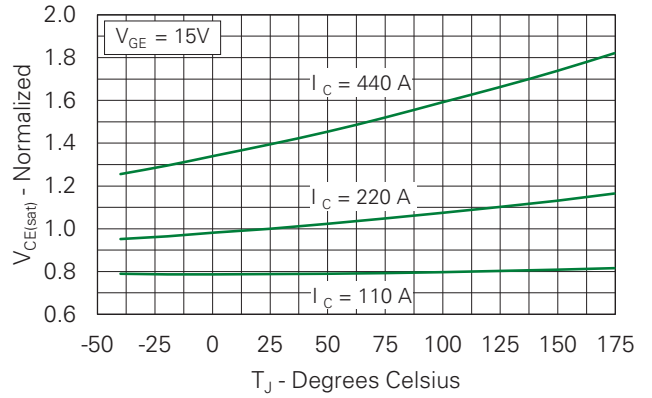

Fig. 5. Collector-to-Emitter Voltage vs. Gate-to-Emitter Voltage

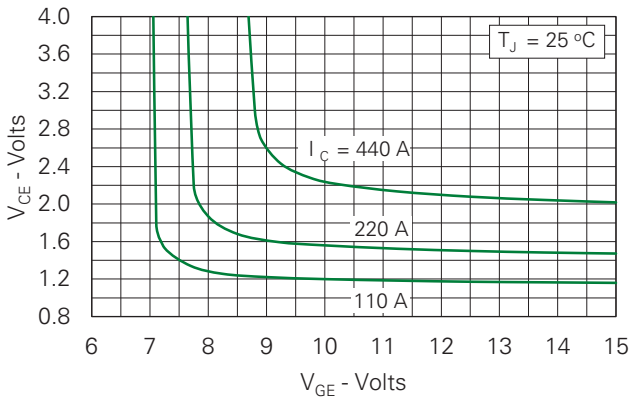

Fig. 6. Input Admittance

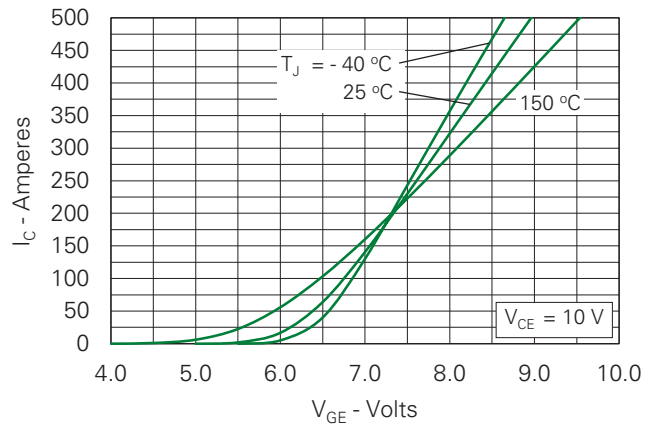

Fig. 7. Transconductance

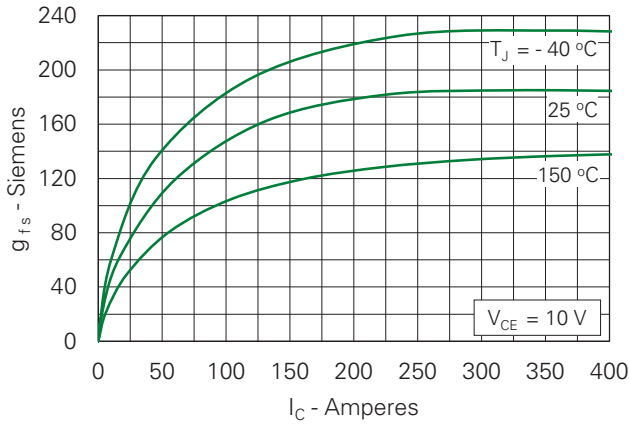

Fig. 8. Gate Charge

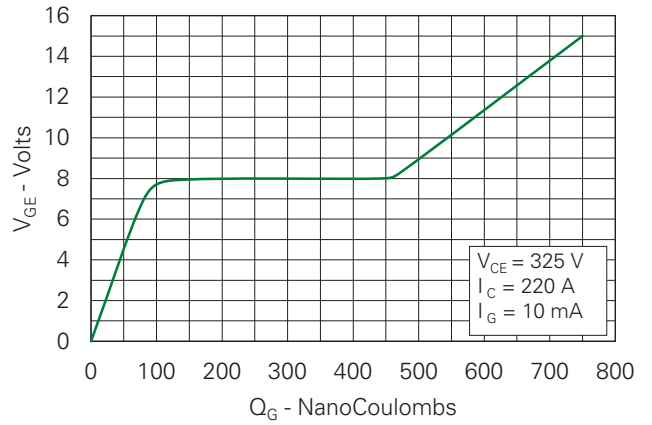

Fig. 9. Capacitance

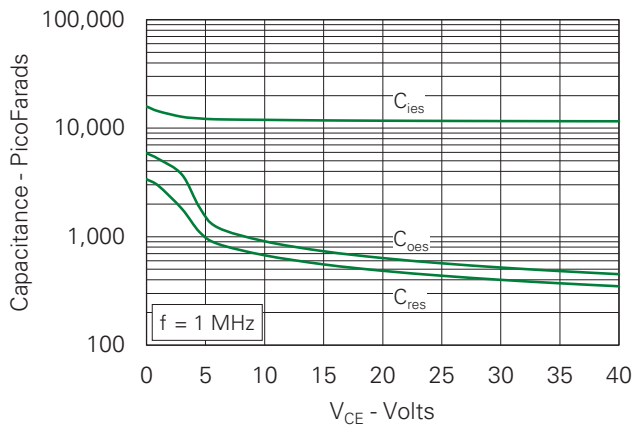

Fig. 10. Reverse-Bias Safe Operating Area

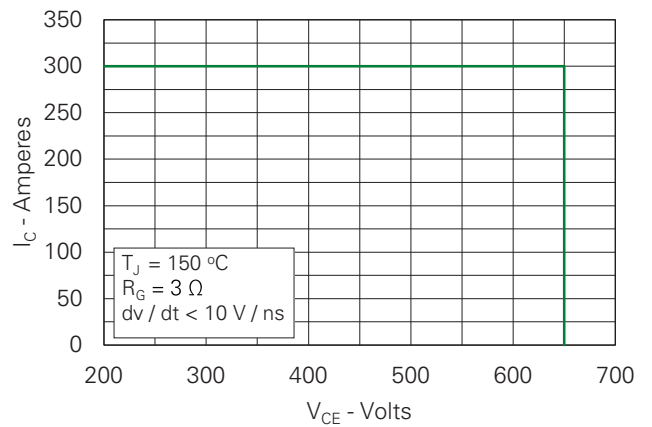

Fig. 11. Maximum Transient Thermal Impedance

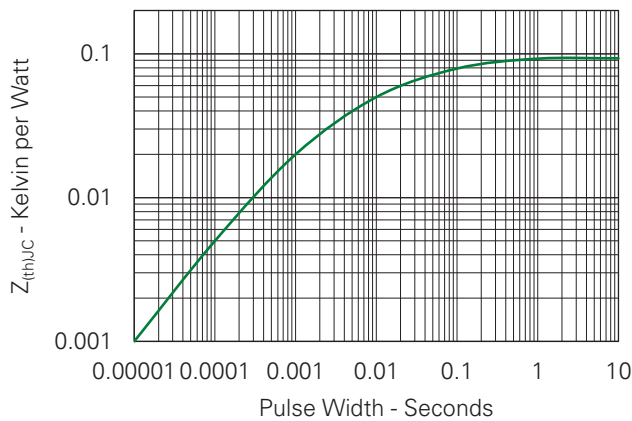

Fig. 12. Inductive Switching Energy Loss vs. Gate Resistance

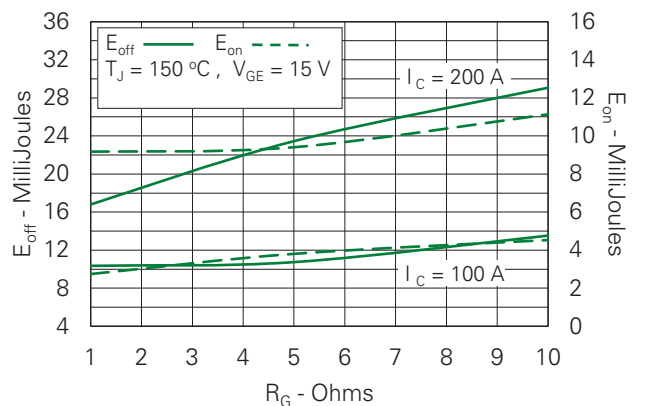

Fig. 13. Inductive Switching Energy Loss vs. Collector Current

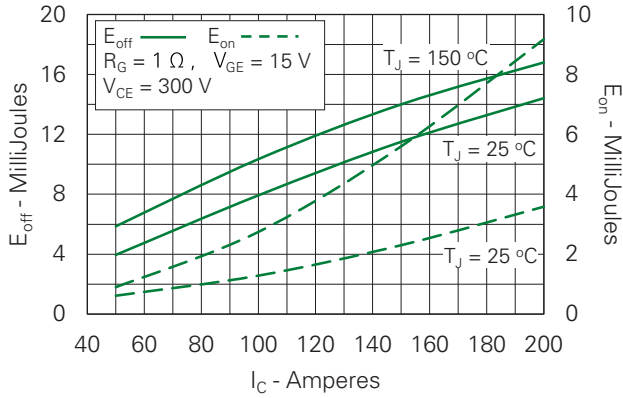

Fig. 14. Inductive Switching Energy Loss vs. Junction Temperature

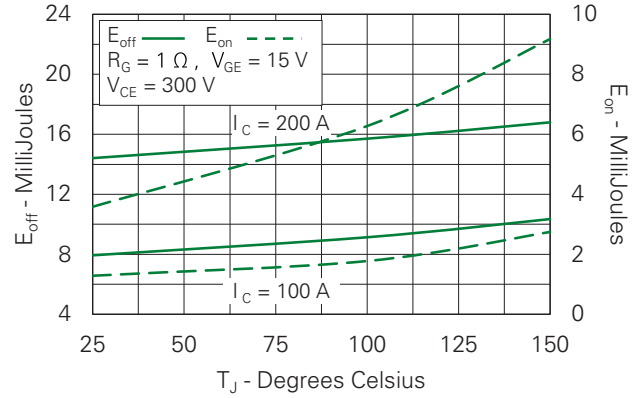

Fig. 15. Inductive Turn-off Switching Times vs. Gate Resistance

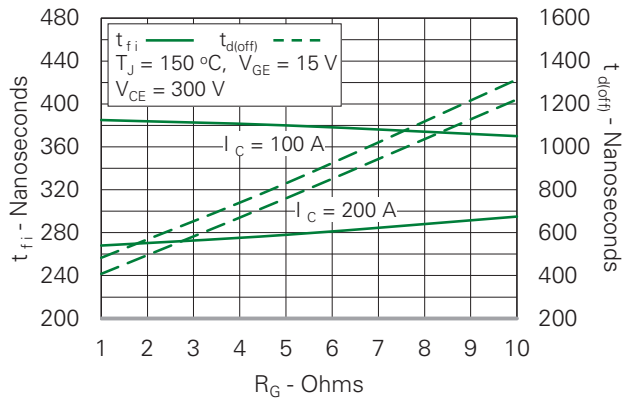

Fig. 16. Inductive Turn-off Switching Times vs. Collector Current

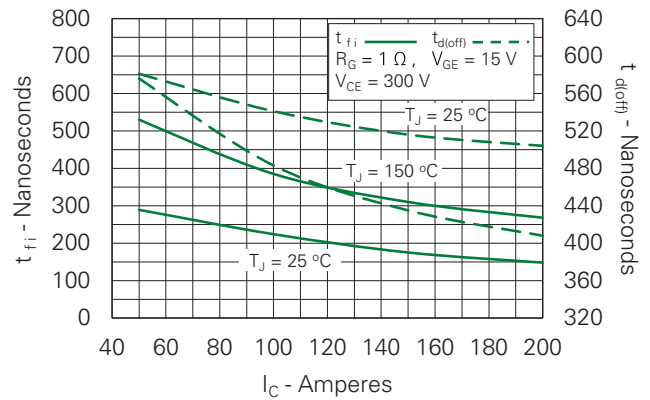

Fig. 17. Inductive Turn-off Switching Times vs. Junction Temperature

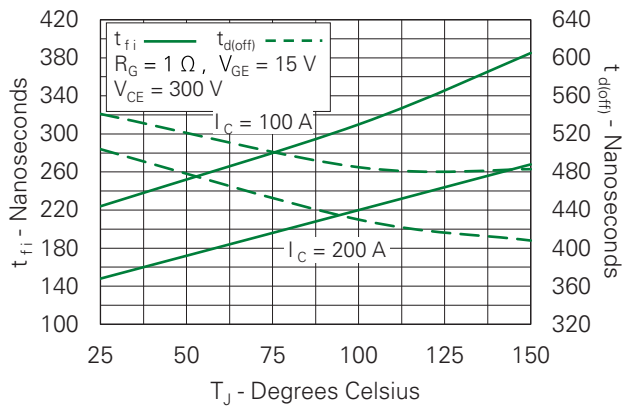

Fig. 18. Inductive Turn-on Switching Times vs. Gate Resistance

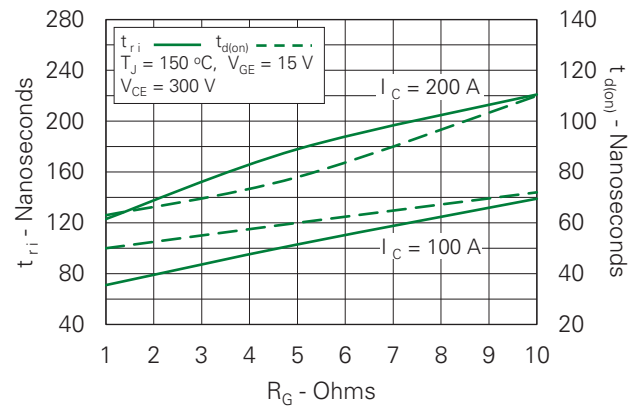

Fig. 19. Inductive Turn-on Switching Times vs. Collector Current

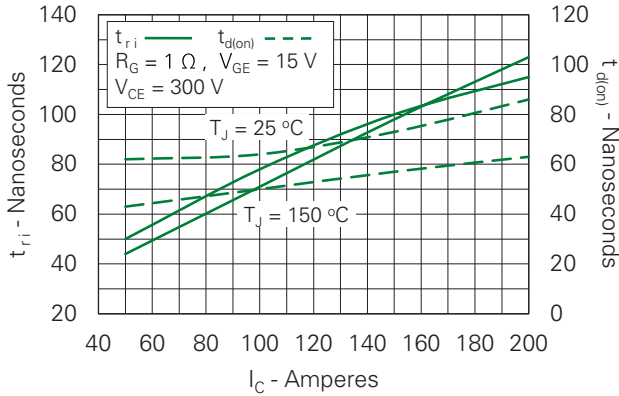
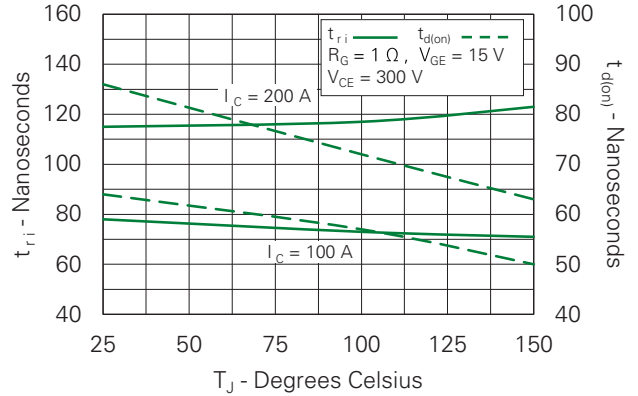
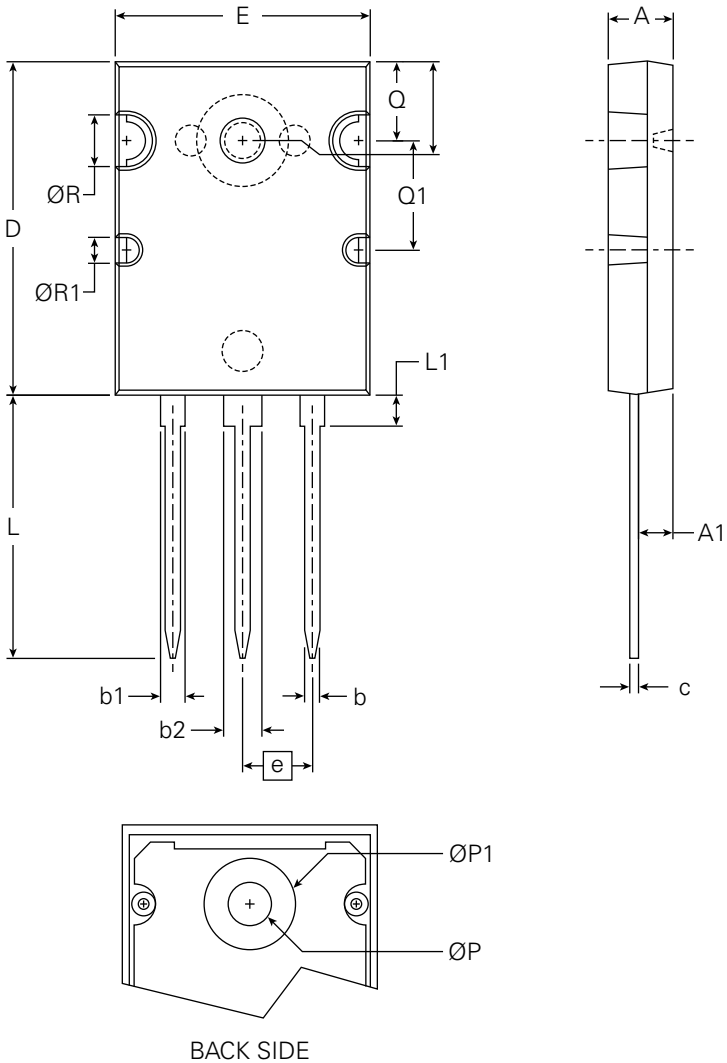

Fig. 20. Inductive Turn-on Switching Times vs. Junction Temperature



Part Outline Drawing TO-264 (IXYK)



Symbol	Inches			Millimeters		
	Min.	Typical	Max.	Min.	Typical	Max.
A	0.185	-	0.209	4.70	-	5.31
A1	0.102	-	0.118	2.59	-	3.00
b	0.037	-	0.55	0.94	-	1.40
b1	0.087	-	0.102	2.21	-	2.59
b2	0.110	-	0.126	2.79	-	3.20
c	0.017	-	0.029	0.43	-	0.74
D	1.007	-	1.047	25.58	-	26.59
E	0.760	-	0.799	19.30	-	20.29
e	0.215 BSC			5.46 BSC		
L1	0.087	-	0.102	2.21	-	2.59
ØP	0.122	-	0.138	3.10	-	3.51
ØP1	0.270	-	0.290	6.86	-	7.37
Q	0.240	-	0.256	6.10	-	6.50
Q1	0.330	-	0.346	8.38	-	8.79
ØR	0.155	-	0.187	3.94	-	4.75
ØR1	0.085	-	0.093	2.16	-	2.36
S	0.243	-	0.253	6.17	-	6.43

Disclaimer Notice

Information furnished is believed to be accurate and reliable. However, users should independently evaluate the suitability of and test each product selected for their own applications. Littelfuse products are not designed for, and may not be used in, all applications. Read complete Disclaimer Notice at <http://www.littelfuse.com/disclaimer-electronics>.



Part of:

