

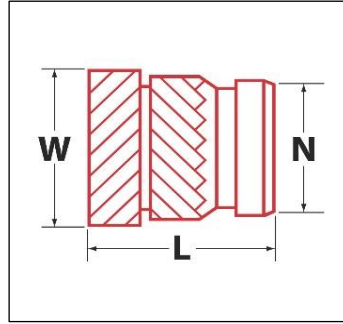

240 E. Rosecrans Avenue | Gardena, CA 90248 | (800) 234-5613 | www.ezlok.com

## Ultrasonic/Heat Stake Insert for Plastic



### SPECS:

Part No: HI-428-WH

Style: Straight; Flush

Installation Method: Ultrasonic or Heat Staking

Material: Brass

For Use In: Thermoplastic

Internal Thread: 1/4-28

Overall Length/in (L): 0.500

Insert Diameter/in (W): 0.341

Pilot Diameter/in (N): 0.312

\*Rec. Hole Size (in.): 0.315

\* Hole size requirements may vary depending on a number of factors, including material and tools.  
We recommend that you test your application prior to production.