

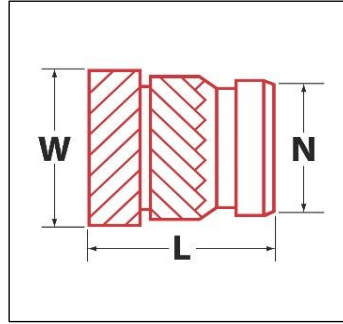

240 E. Rosecrans Avenue | Gardena, CA 90248 | (800) 234-5613 | www.ezlok.com

Ultrasonic/Heat Stake Insert for Plastic



SPECS:

Part No: HI-324-WH

Style: Straight; Flush

Installation Method: Ultrasonic or Heat Staking

Material: Brass

For Use In: Thermoplastic

Internal Thread: 3/8-24

Overall Length/in (L): 0.500

Insert Diameter/in (W): 0.494

Pilot Diameter/in (N): 0.465

*Rec. Hole Size (in.): 0.469

* Hole size requirements may vary depending on a number of factors, including material and tools.
We recommend that you test your application prior to production.