

Ferrite Chip Inductor(Lead Free) FCI-SERIES

1. Features

1. Monolithic inorganic material construction.
2. Closed magnetic circuit avoids crosstalk.
3. S.M.T. type.
4. Suitable for reflow soldering.
5. Shapes and dimensions follow E.I.A. spec.
6. Available in various sizes.
7. Excellent solder ability and heat resistance.
8. High reliability.
9. 100% Lead(Pb) & Halogen-Free and RoHS compliant.
10. Operating Temperature: -55~+105°C (Including self-temperature rise)



2. Dimension

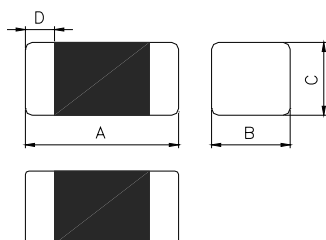

Chip size				
Size	A(mm)	B(mm)	C(mm)	D(mm)
1005	1.00±0.10	0.50±0.10	0.50±0.10	0.25±0.1
1608	1.60±0.15	0.80±0.15	0.80±0.15	0.30±0.2
2012	2.00±0.2	1.25±0.2	0.85±0.2	0.5±0.3
			1.25±0.2	
3216	3.20±0.2	1.60±0.20	1.10±0.20	0.50±0.30

3. Part Numbering

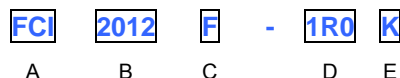

- A: Series
 - B: Dimension
 - C: Material
 - D: Inductance
 - E: Inductance Tolerance
- L x W
Lead Free Material
1R0=1.0uH
K=±10%, L=±15%, M=±20%

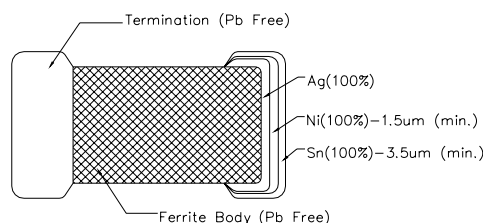

4. Specification

TAI-TECH Part Number	Thickness C size (mm)	Inductance (uH)	Q min.	Test Frequency (MHz)	Rated Current (mA) max.	DC Resistance (Ohm) max.	SRF (MHz) min.
FCI1005F-1R0□	0.5±0.10	1.0	20	10	15	0.90	40
FCI1005F-1R8□	0.5±0.10	1.8	20	10	15	1.45	30
FCI1005F-2R2□	0.5±0.10	2.2	20	10	10	1.70	28
FCI1608F-47N□	0.8±0.15	0.047	10	50	50	0.30	260
FCI1608F-68N□	0.8±0.15	0.068	10	50	50	0.30	250
FCI1608F-82N□	0.8±0.15	0.082	10	50	50	0.30	245
FCI1608F-R10□	0.8±0.15	0.10	15	25	50	0.50	240
FCI1608F-R12□	0.8±0.15	0.12	15	25	50	0.50	205
FCI1608F-R15□	0.8±0.15	0.15	15	25	50	0.60	180
FCI1608F-R18□	0.8±0.15	0.18	15	25	50	0.60	165
FCI1608F-R22□	0.8±0.15	0.22	15	25	50	0.80	150
FCI1608F-R27□	0.8±0.15	0.27	15	25	50	0.80	136
FCI1608F-R33□	0.8±0.15	0.33	15	25	35	0.85	125

● TOLERANCE K:±10% L:±15% M:±20%.

TAI-TECH Part Number	Thickness C size (mm)	Inductance (uH)	Q min.	Test Frequency (MHz)	Rated Current (mA) max.	DC Resistance (Ohm) max.	SRF (MHz) min.
FCI1608F-R39□	0.8±0.15	0.39	15	25	35	1.00	110
FCI1608F-R47□	0.8±0.15	0.47	15	25	35	1.35	105
FCI1608F-R56□	0.8±0.15	0.56	15	25	35	1.55	95
FCI1608F-R68□	0.8±0.15	0.68	15	25	35	1.70	80
FCI1608F-R82□	0.8±0.15	0.82	15	25	35	2.10	75
FCI1608F-1R0□	0.8±0.15	1.0	30	10	25	0.60	70
FCI1608F-1R5□	0.8±0.15	1.5	30	10	25	0.80	55
FCI1608F-1R8□	0.8±0.15	1.8	30	10	25	0.95	50
FCI1608F-2R2□	0.8±0.15	2.2	30	10	15	1.15	45
FCI1608F-3R3□	0.8±0.15	3.3	30	10	15	1.55	38
FCI1608F-4R7□	0.8±0.15	4.7	30	10	15	2.10	33
FCI1608TF-100□	0.8±0.15	10.0	30	2	15	2.55	17
FCI2012F-47N□	0.85±0.2	0.047	15	50	300	0.20	320
FCI2012F-R10□	0.85±0.2	0.10	20	25	250	0.30	235
FCI2012F-R12□	0.85±0.2	0.12	20	25	250	0.30	220
FCI2012F-R15□	0.85±0.2	0.15	20	25	250	0.40	200
FCI2012F-R18□	0.85±0.2	0.18	20	25	250	0.40	185
FCI2012F-R22□	0.85±0.2	0.22	20	25	250	0.50	170
FCI2012F-R27□	0.85±0.2	0.27	20	25	250	0.50	150
FCI2012F-R33□	0.85±0.2	0.33	20	25	250	0.55	145
FCI2012F-R39□	0.85±0.2	0.39	25	25	200	0.65	135
FCI2012F-R47□	1.25±0.2	0.47	25	25	200	0.65	125
FCI2012F-R56□	1.25±0.2	0.56	25	25	150	0.75	115
FCI2012F-R68□	1.25±0.2	0.68	25	25	150	0.80	105
FCI2012F-1R0□	0.85±0.2	1.0	45	10	50	0.40	75
FCI2012F-1R5□	0.85±0.2	1.5	45	10	50	0.50	60
FCI2012F-1R8□	0.85±0.2	1.8	45	10	50	0.60	55
FCI2012F-2R2□	0.85±0.2	2.2	45	10	30	0.65	50
FCI2012F-2R7□	1.25±0.2	2.7	45	10	30	0.75	45
FCI2012F-3R3□	1.25±0.2	3.3	45	10	30	0.80	41
FCI2012F-4R7□	1.25±0.2	4.7	45	10	30	1.00	35
FCI2012F-100□	1.25±0.2	10.0	45	2	15	1.15	24
FCI3216F-1R0□	1.10±0.20	1.0	45	10	100	0.40	75
FCI3216F-2R2□	1.10±0.20	2.2	45	10	50	0.60	50
FCI3216F-4R7□	1.10±0.20	4.7	45	10	50	0.90	35
FCI3216F-100□	1.10±0.20	10.0	50	2	25	1.00	24

● TOLERANCE K:±10% L:±15% M:±20%.

● Rated current: based on temperature rise test

● In compliance with EIA 595

5. Reliability and Test Condition

Item	Performance				Test Condition															
Series No.	FCI	FHI	FCH	HCI	--															
Operating Temperature	-55~+105°C (Including self-temperature rise)				--															
Transportation Storage Temperature	-55~+105°C (on board)				For long storage conditions, please see the Application Notice															
Inductance (Ls)	Refer to standard electrical characteristics list				Agilent4291															
Q Factor					Agilent E4991															
DC Resistance					Agilent4287															
Rated Current					Agilent16192															
Rated Current					Agilent 4338															
Temperature Rise Test	Rated Current < 1A ΔT 20°CMax Rated Current ≥ 1A ΔT 40°CMax				1. Applied the allowed DC current. 2. Temperature measured by digital surface thermometer.															
Life test	Appearance: no damage.				Preconditioning: Run through reflow for 3 times.(IPC/JEDEC J-STD-020E Classification Reflow Profiles) Temperature: 105±2°C Applied current: rated current. Duration: 1000±12hrs. Measured at room temperature after placing for 24±2 hrs.															
Load Humidity	Inductance: within±10%of initial value. Q : Shall not exceed the specification value. RDC : within ±15% of initial value and shall not exceed the specification value				Preconditioning: Run through reflow for 3 times.(IPC/JEDEC J-STD-020E Classification Reflow Profiles) Humidity: 85±2%R.H. Temperature: 85±2°C. Duration:1000hrsMin.Bead:with100%ratedcurrent Inductance: with 10% rated current Measured at room temperature after placing for 24±2 hrs.															
Thermal shock	Appearance: no damage. Inductance: within±10%of initial value. Q : Shall not exceed the specification value. RDC : within ±15% of initial value and shall not exceed the specification value				Preconditioning: Run through reflow for 3 times.(IPC/JEDEC J-STD-020E Classification Reflow Profiles) Condition for 1 cycle Step1: -55±2°C 30±5 min. Step2: 105±2°C ≤0.5min Step3: 105±2°C 30±5min. Number of cycles: 500 Measured at room temperature after placing for 24±2 hrs.															
Vibration	Appearance : No damage. Inductance : within±10% of initial value Q : Shall not exceed the specification value. RDC : within ±15% of initial value and shall not exceed the specification value				Preconditioning: Run through reflow for 3 times.(IPC/JEDEC J-STD-020E Classification Reflow Profiles) Oscillation Frequency: 10Hz ~ 2KHz ~ 10Hz for 20 minutes Equipment : Vibration checker Total Amplitude:10g Testing Time : 12 hours(20 minutes, 12 cycles each of 3 orientations)															
Bending	Appearance : No damage. Inductance : within±10% of initial value Q : Shall not exceed the specification value. RDC : within ±15% of initial value and shall not exceed the specification value				Shall be mounted on a FR4 substrate of the following dimensions: ≥0805inch(2012mm):40x100x1.2mm <0805inch(2012mm):40x100x0.8mm Bending depth: ≥0805inch(2012mm):1.2mm <0805inch(2012mm):0.8mm Duration of 10 sec for a min.															
Shock	Appearance : No damage. Inductance : within±10% of initial value Q : Shall not exceed the specification value. RDC : within ±15% of initial value and shall not exceed the specification value				Test condition: <table border="1"> <thead> <tr> <th>Type</th> <th>Peak Value (g's)</th> <th>Normal duration (D) (ms)</th> <th>Wave form</th> <th>Velocity change (V)/ft/sec</th> </tr> </thead> <tbody> <tr> <td>SMD</td> <td>50</td> <td>11</td> <td>Half-sine</td> <td>11.3</td> </tr> <tr> <td>Lead</td> <td>50</td> <td>11</td> <td>Half-sine</td> <td>11.3</td> </tr> </tbody> </table>	Type	Peak Value (g's)	Normal duration (D) (ms)	Wave form	Velocity change (V)/ft/sec	SMD	50	11	Half-sine	11.3	Lead	50	11	Half-sine	11.3
Type	Peak Value (g's)	Normal duration (D) (ms)	Wave form	Velocity change (V)/ft/sec																
SMD	50	11	Half-sine	11.3																
Lead	50	11	Half-sine	11.3																
Insulation Resistance	IR>1GΩ				Chip Inductor Only Test Voltage:100±10%V for 30Sec.															
Solderability	More than 95% of the terminal electrode should be covered with solder.				a.Method B, 4 hrs @155°C dry heat @235°C±5°C Test time:5 +0/-0.5 seconds. b. Method D category 3. (steam aging 8hours ± 15 min)@ 260°C±5°C Test time: 30 +0/-0.5 seconds.															

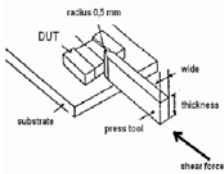
Item	Performance	Test Condition				
Resistance to Soldering Heat	Appearance : No damage. Inductance : within±10% of initial value Q : Shall not exceed the specification value. RDC : within ±15% of initial value and shall not exceed the specification value	Number of heat cycles: 1				
		<table border="1"> <thead> <tr> <th>Temperature (°C)</th> <th>Time (s)</th> <th>Temperature ramp/immersion and emersion rate</th> </tr> </thead> <tbody> <tr> <td>260 ±5 (solder temp)</td> <td>10 ±1</td> <td>25mm/s ±6 mm/s</td> </tr> </tbody> </table>	Temperature (°C)	Time (s)	Temperature ramp/immersion and emersion rate	260 ±5 (solder temp)
Temperature (°C)	Time (s)	Temperature ramp/immersion and emersion rate				
260 ±5 (solder temp)	10 ±1	25mm/s ±6 mm/s				
		Depth: completely cover the termination				
Terminal strength	Appearance : No damage. Inductance : within±10% of initial value Q : Shall not exceed the specification value. RDC : within ±15% of initial value and shall not exceed the specification value	 <p>Preconditioning: Run through reflow for 3 times. (IPC/JEDEC J-STD-020E Classification Reflow Profiles) Component mounted on a PCB apply a force >0805inch(2012mm):1kg <=0805inch(2012mm):0.5kg to the side of a device being tested. This force shall be applied for 60 +1 seconds. Also the force shall be applied gradually as not to shock the component being tested.</p>				

****Derating Curve**

For the ferrite chip bead which withstanding current over 1.5A, as the operating temperature over 85°C, the derating current information is necessary to consider with. For the detail derating of current, please refer to the Derated Current vs. Operating Temperature curve.

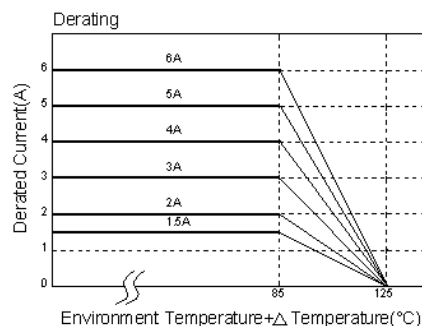

6.Soldering and Mounting

6-1. Recommended PC Board Pattern

Chip Size						Land Patterns For Reflow Soldering		
Series	Type	A(mm)	B(mm)	C(mm)	D(mm)	E(mm)	F(mm)	G(mm)
FCB	1005	1.0±0.10	0.50±0.10	0.50±0.10	0.25±0.10	0.50	0.40	0.60
FCM	1608	1.6±0.15	0.80±0.15	0.80±0.15	0.30±0.20	0.80	0.85	0.95
HCB	2012	2.0±0.20	1.25±0.20	0.85±0.20	0.50±0.30	1.05	1.00	1.45
GHB		2.0±0.20	1.25±0.20	1.25±0.20	0.50±0.30			
FCl	3216	3.2±0.20	1.60±0.20	1.10±0.20	0.50±0.30	1.05	2.20	1.80
FHI	3225	3.2±0.20	2.50±0.20	1.30±0.20	0.50±0.30	1.05	2.20	2.70
FCH	4516	4.5±0.20	1.60±0.20	1.60±0.20	0.50±0.30	1.05	3.30	1.80
HCI	4532	4.5±0.20	3.20±0.20	1.50±0.20	0.50±0.30	1.05	3.30	3.40

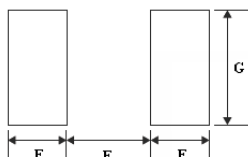
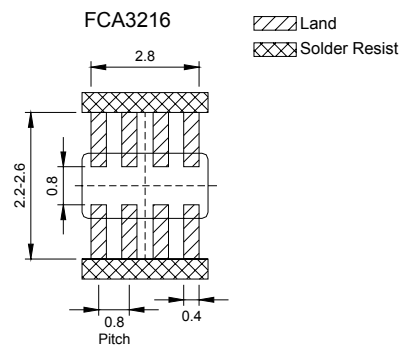

PC board should be designed so that products can prevent damage from mechanical stress when warping the board.

6-2. Soldering

Mildly activated rosin fluxes are preferred. TAI-TECH terminations are suitable for re-flow soldering systems. If hand soldering cannot be avoided, the preferred technique is the utilization of hot air soldering tools.

6-2.1 IR Soldering Reflow:

Recommended temperature profiles for lead free re-flow soldering in Figure 1. Table 1.1&1.2 (J-STD-020E)

6-2.2 Soldering Iron:

Products attachment with a soldering iron is discouraged due to the inherent process control limitations. In the event that a soldering iron must be employed the following precautions are recommended. (Figure 2.)

- Preheat circuit and products to 150°C
- Never contact the ceramic with the iron tip
- Use a 20 watt soldering iron with tip diameter of 1.0mm
- 350°C tip temperature (max)
- 1.0mm tip diameter (max)
- Limit soldering time to 4-5sec.

Fig.1 IR Soldering Reflow

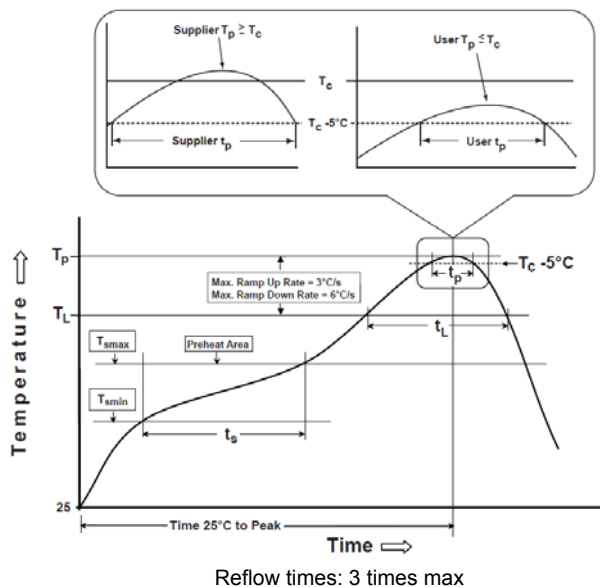

Fig.2 Iron soldering temperature profiles

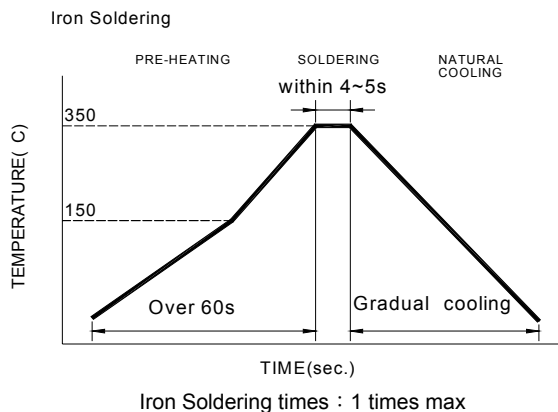

Table (1.1): Reflow Profiles

Profile Type:	Pb-Free Assembly
Preheat	
-Temperature Min(T_{smin})	150°C
-Temperature Max(T_{smax})	200°C
-Time(t_s)from(T_{smin} to T_{smax})	60-120seconds
Ramp-up rate(T_L to T_p)	3°C/second max.
Liquidus temperature(T_L)	217°C
Time(t_L)maintained above T_L	60-150 seconds
Classification temperature(T_c)	See Table (1.2)
Time(t_p) at $T_c - 5^\circ C$ (T_p should be equal to or less than T_c .)	< 30 seconds
Ramp-down rate(T_p to T_L)	6°C /second max.
Time 25°C to peak temperature	8 minutes max.

Tp: maximum peak package body temperature, **Tc**: the classification temperature.
For user (customer) **Tp** should be equal to or less than **Tc**.

Table (1.2) Package Thickness/Volume and Classification Temperature (T_c)

	Package Thickness	Volume mm ³ <350	Volume mm ³ 350-2000	Volume mm ³ >2000
PB-Free Assembly	<1.6mm	260°C	260°C	260°C
	1.6-2.5mm	260°C	250°C	245°C
	≥2.5mm	250°C	245°C	245°C

Reflow is referred to standard IPC/JEDEC J-STD-020E ◊

6-2.3 Solder Volume:

Accordingly increasing the solder volume, the mechanical stress to product is also increased. Exceeding solder volume may cause the failure of mechanical or electrical performance. Solder shall be used not to be exceed as shown in right side:

Minimum fillet height = soldering thickness + 25% product height

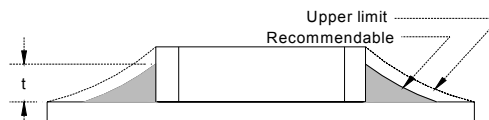

7.Packaging Information

7-1. Reel Dimension

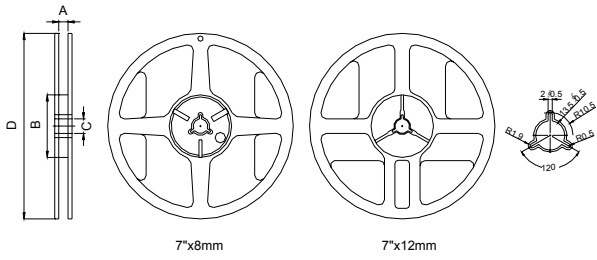

Type	A(mm)	B(mm)	C(mm)	D(mm)
7"x8mm	9.0±0.5	60±2	13.5±0.5	178±2
7"x12mm	13.5±0.5	60±2	13.5±0.5	178±2

7-2.1 Tape Dimension / 8mm

Material of taping is paper

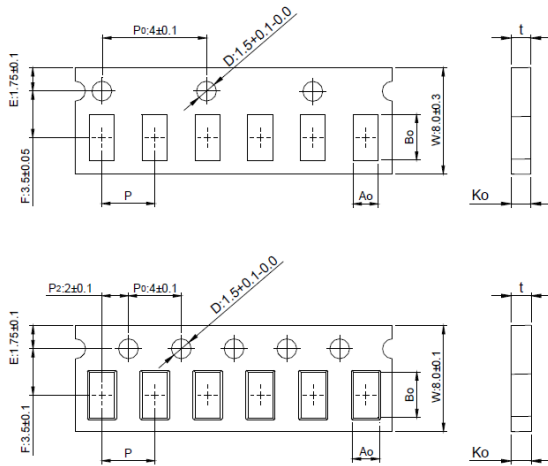

Size	Bo(mm)	Ao(mm)	Ko(mm)	P(mm)	t(mm)
100505	1.12±0.03	0.62±0.03	0.60±0.03	2.0±0.05	0.60±0.03

Size	Bo(mm)	Ao(mm)	Ko(mm)	P(mm)	t(mm)
160808	1.80±0.05	0.96±0.05/-0.03	0.95±0.05	4.0±0.10	0.95±0.05
201209	2.10±0.05	1.30±0.05	0.95±0.05	4.0±0.10	0.95±0.05

Material of taping is plastic

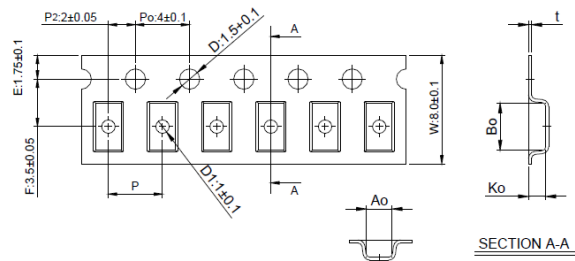

Size	Bo(mm)	Ao(mm)	Ko(mm)	P(mm)	t(mm)	D1(mm)
201212	2.10±0.10	1.28±0.10	1.28±0.10	4.0±0.10	0.22±0.05	1.0±0.10
321611	3.35±0.10	1.75±0.10	1.25±0.10	4.0±0.10	0.23±0.05	1.0±0.10
322513	3.42±0.10	2.77±0.10	1.55±0.10	4.0±0.10	0.22±0.05	1.0±0.10
321609	3.40±0.10	1.77±0.10	1.04±0.10	4.0±0.10	0.22±0.05	1.0±0.10

7-2.2 Tape Dimension / 12mm

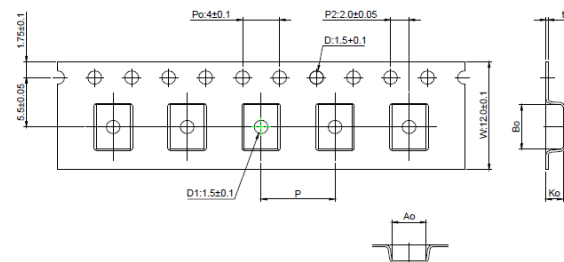

Size	Bo(mm)	Ao(mm)	Ko(mm)	P(mm)	t(mm)	D1(mm)
451616	4.70±0.10	1.75±0.10	1.75±0.10	4.0±0.10	0.24±0.05	1.5±0.10
453215	4.70±0.10	3.45±0.10	1.60±0.10	8.0±0.10	0.24±0.05	1.5±0.10

7-3. Packaging Quantity

Chip Size	453215	451616	322513	321611	321609	201212	201209	160808	100505
Chip / Reel	1000	2000	2500	3000	3000	2000	4000	4000	10000
Inner box	4000	8000	12500	15000	15000	10000	20000	20000	50000
Middle box	20000	40000	62500	75000	75000	50000	100000	100000	250000
Carton	40000	80000	125000	150000	150000	100000	200000	200000	500000

7-4. Tearing Off Force

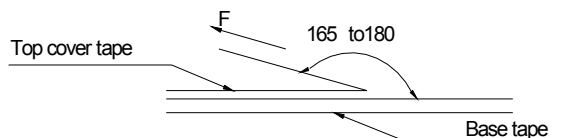

The force for tearing off cover tape is 15 to 60 grams in the arrow direction under the following conditions.

Room Temp. (°C)	Room Humidity (%)	Room atm (hPa)	Tearing Speed mm/min
5~35	45~85	860~1060	300

Application Notice

- Storage Conditions(component level)
 - To maintain the solder ability of terminal electrodes:
 1. TAI-TECH products meet IPC/JEDEC J-STD-020E standard-MSL, level 1.
 2. Temperature and humidity conditions: Less than 40°C and 60% RH.
 3. Recommended products should be used within 12 months from the time of delivery.
 4. The packaging material should be kept where no chlorine or sulfur exists in the air.
- Transportation
 1. Products should be handled with care to avoid damage or contamination from perspiration and skin oils.
 2. The use of tweezers or vacuum pick up is strongly recommended for individual components.
 3. Bulk handling should ensure that abrasion and mechanical shock are minimized.

Typical Inductance v.s. Frequency Curve

