

LM317

3-TERMINAL ADJUSTABLE VOLTAGE REGULATOR

General Description

The LM317 is an adjustable three-terminal positive voltage regulator with a very low dropout of 1.2V at 1.2A output current. Using 2 external resistors, the LM317 can provide an adjustable output voltage down to 1.25V.

The LM317 includes a circuit of trimmed bandgap reference to assure output voltage accuracy to be within 1%. It also provides current limiting and thermal shut-down. The current limit is trimmed to ensure specified output current and controlled short-circuit current. The On-chip thermal limiting provides protection against any combination of overload and ambient temperature that would create excessive junction temperature.

The LM317 is available in the standard SOT-223, TO-220-3, TO-252-2 (1) and TO-263-3 power packages.

Features

- Typical 1% Output Voltage Tolerance
- Typical 0.01%/V Line Regulation
- Typical 0.2% Load Regulation
- Very Low Dropout Voltage: 1.2V at 1.2A Output Current
- Trimmed Current Limit
- On-chip Thermal Protection
- Operation Junction Temperature: 0 to 125°C

Applications

- PC Motherboard
- LCD Monitor
- Graphic Card
- DVD Player
- Network Interface Card/Switch
- Telecom Equipment
- Printer and other Peripheral Equipment

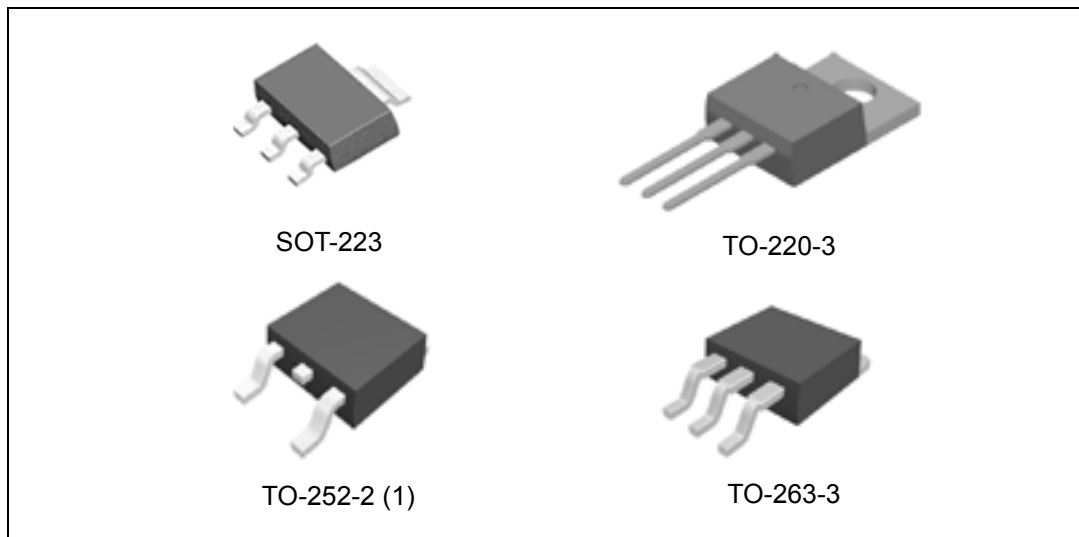

Figure 1. Package Types of LM317

LM317

3-TERMINAL ADJUSTABLE VOLTAGE REGULATOR

Pin Configuration

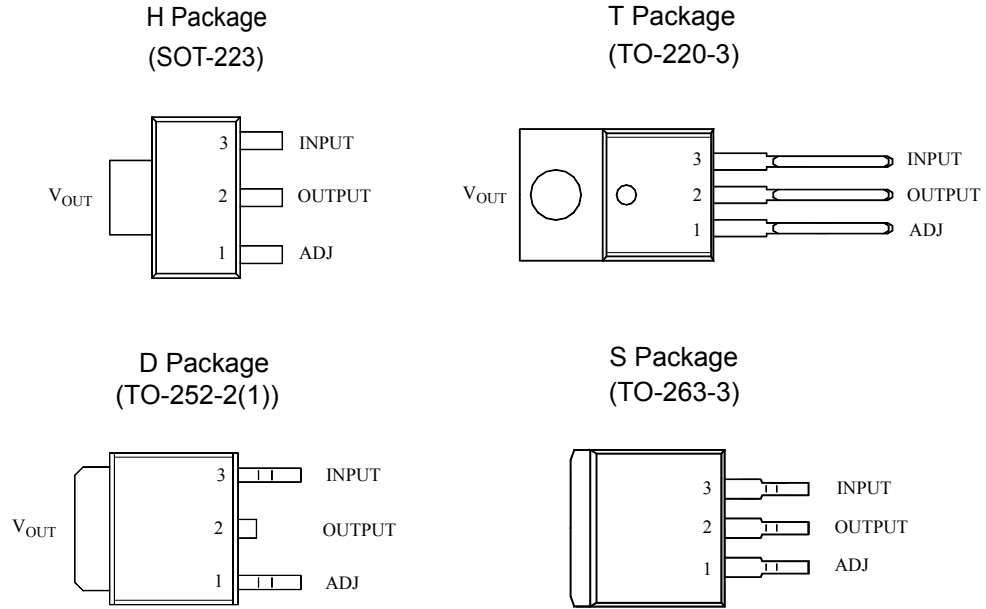

Figure 2. Pin Configuration of LM317 (Top View)

Functional Block Diagram

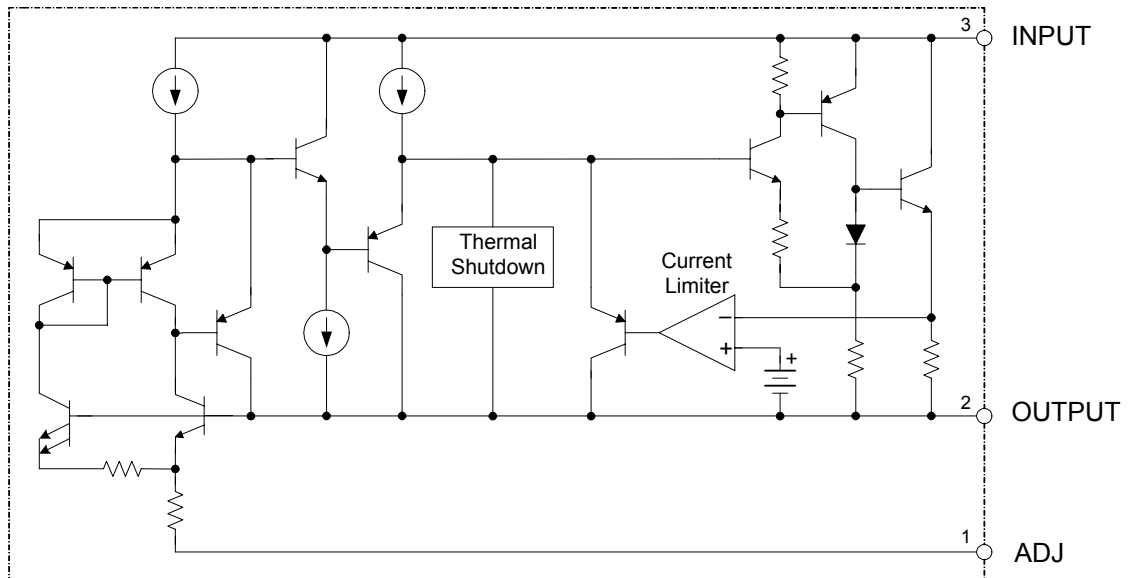

Figure 3. Functional Block Diagram of LM317

LM317

3-TERMINAL ADJUSTABLE VOLTAGE REGULATOR**Absolute Maximum Ratings (Note 1)**

Parameter	Symbol	Min	Max	Unit
Input Voltage	V_{IN}		40	V
Maximum Junction Temperature	T_J		150	°C
Storage Temperature	T_S	-65	150	°C
Lead Temperature (Soldering, 10sec)	T_{LEAD}		300	°C
ESD (Human Body Model)	ESD		3000	V

Note1: Stresses greater than those listed under "Absolute Maximum Ratings" may cause permanent damage to the device. These are stress ratings only, and functional operation of the device at these or any other conditions beyond those indicated under "Recommended Operating Conditions" is not implied. Exposure to "Absolute Maximum Ratings" for extended periods may affect device reliability.

Recommended Operating Conditions

Parameter	Symbol	Min	Max	Unit
Input Voltage	V_{IN}	$V_{OUT}+2$	40	V
Operating Junction Temperature Range	T_J	0	125	°C

3-TERMINAL ADJUSTABLE VOLTAGE REGULATOR

Electrical Characteristics

$V_{IN}-V_{OUT}=5V$, $I_{OUT} = 10mA$, $T_J = 25^{\circ}C$, unless otherwise specified.)(Note 2)

Parameter	Symbol	Conditions	Min	Typ	Max	Unit
Reference Voltage	V_{REF}	$10mA \leq I_{OUT} \leq I_{MAX}$, $P \leq P_{MAX}$, $3V \leq (V_{IN}-V_{OUT}) \leq 40V$	1.20	1.25	1.30	V
Line Regulation	S_V	$I_{OUT} \leq 20mA$, $3V \leq V_{IN}-V_{OUT} \leq 40V$		0.01	0.04	%/V
		$10mA \leq I_{OUT} \leq I_{MAX}$, $P \leq P_{MAX}$,		0.2	0.5	%
Thermal Regulation		20ms Pulse		0.04	0.07	%/W
Current Limit	I_{LIMIT}	$(V_{IN}-V_{OUT}) = 2V$	1.5	2.2	3.4	A
Adjust Pin Current				50	100	μA
Adjust Pin Current Change		$3V \leq (V_{IN}-V_{OUT}) \leq 40V$, $10mA \leq I_{OUT} \leq 1.2A$		0.2	5	μA
Minimum Load Current		$3V \leq (V_{IN}-V_{OUT}) \leq 40V$		3.5	10	mA
Ripple Rejection		$f=120Hz$, $C_{OUT}=1$ $V_{OUT}=10V$, $C_{ADJ}=10_{\mu F}$	60	75		dB
Temperature Stability				1		%
Long -Term Stability		$T_A=125^{\circ}C$, 1000hrs		0.3		%
RMS Output Noise (% of V_{OUT})		$T_A=25^{\circ}C$, $10Hz \leq f \leq 10kHz$		0.003		%
Thermal Resistance, Junction to Case		SOT-223 TO-252 TO-220 TO-263		15 10 4.5 4		$^{\circ}C/W$
Thermal Shutdown		Junction Temperature		150		$^{\circ}C$
Thermal Shutdown Hysteresis				25		$^{\circ}C$

Note 2: Maximum Power Dissipation is Package Type and Case Temperature dependent.

Package	TO-3	TO-39	TO-220	TO-263	TO-252	SOT-223
I_{MAX}	1.2	0.5	1.2	1.2	0.5	1
P_{MAX}	20	2	20	20		2

3-TERMINAL ADJUSTABLE VOLTAGE REGULATOR

Typical Performance Characteristics

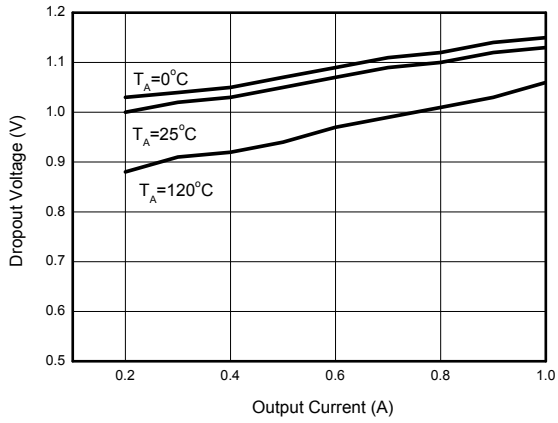

Figure 5. Dropout Voltage vs. Output Current

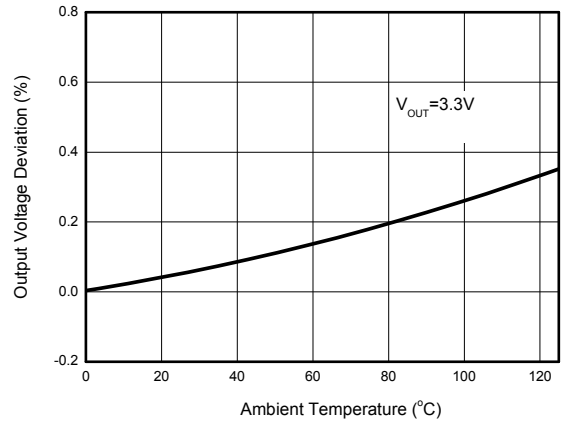

Figure 6. Load Regulation vs. Temperature

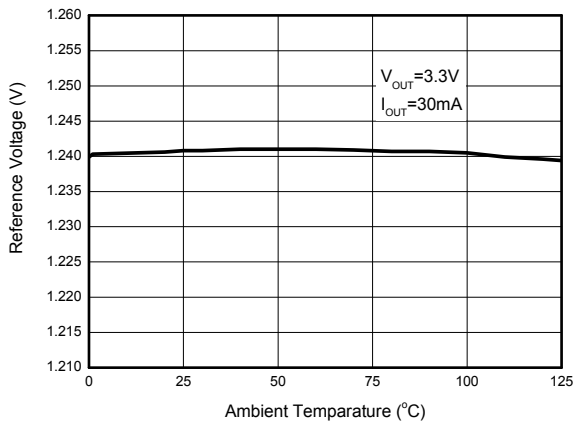

Figure 7. Reference Voltage vs. Temperature

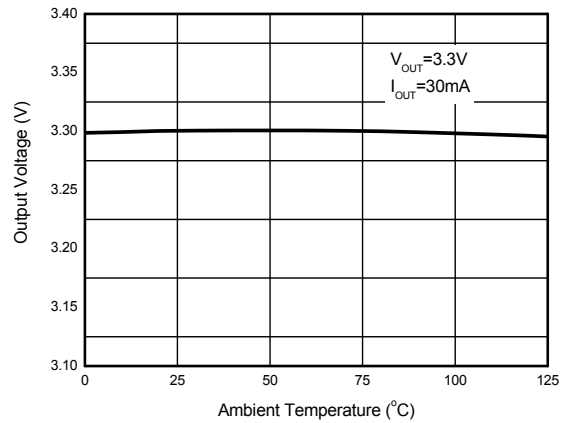

Figure 8. Output Voltage vs. Temperature

LM317

3-TERMINAL ADJUSTABLE VOLTAGE REGULATOR

Typical Performance Characteristics (Continued)

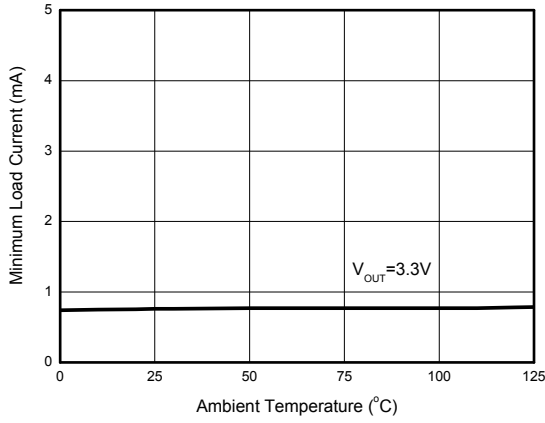

Figure 9. Minimum Load Current vs. Temperature

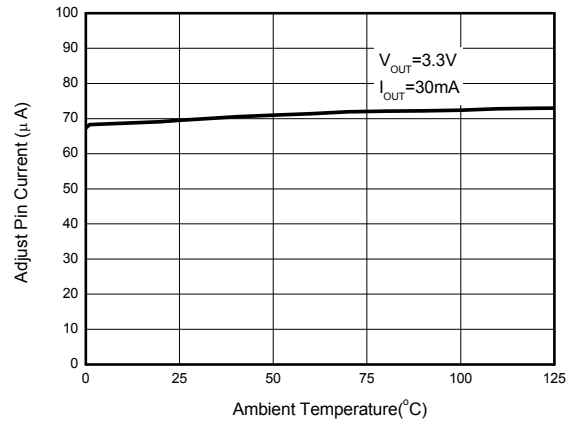

Figure 10. Adjust Pin Current vs. Temperature

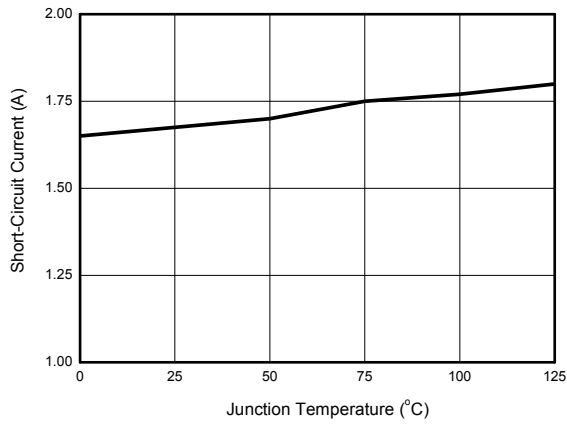

Figure 11. Short-Circuit Current vs. Temperature

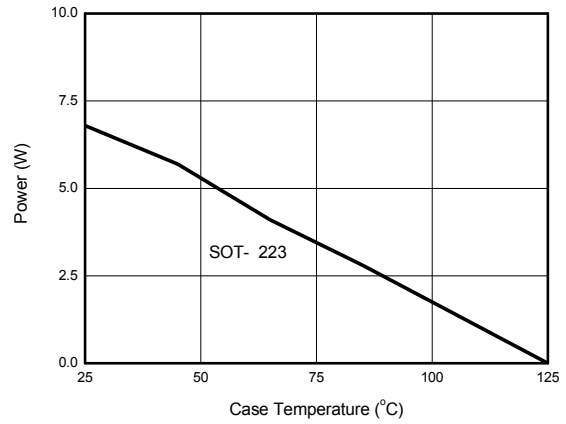

Figure 12. Maximum Power Dissipation

LM317

3-TERMINAL ADJUSTABLE VOLTAGE REGULATOR

Typical Performance Characteristics (Continued)

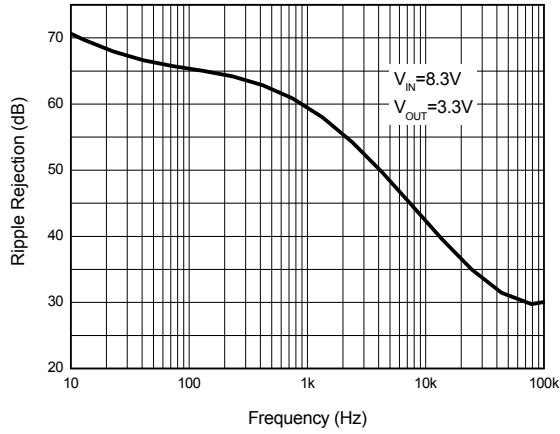

Figure 13. Ripple Rejection vs. Frequency

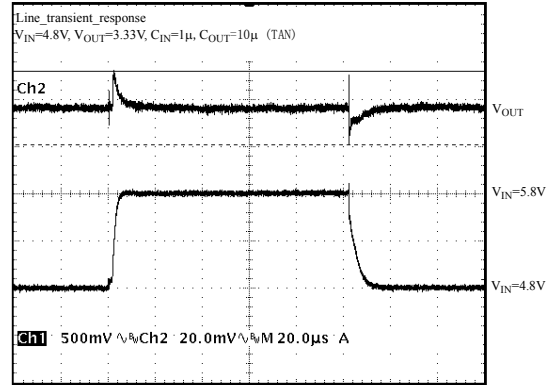

Figure 14. Line Transient Response

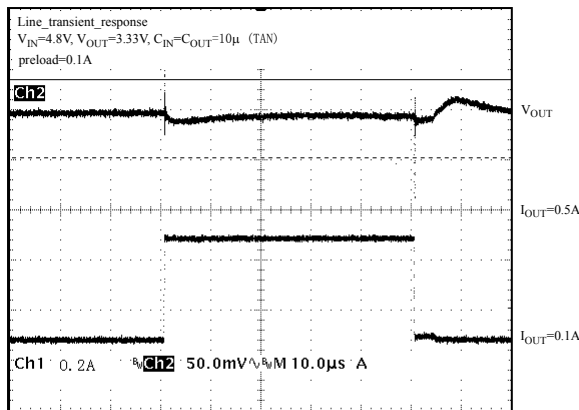
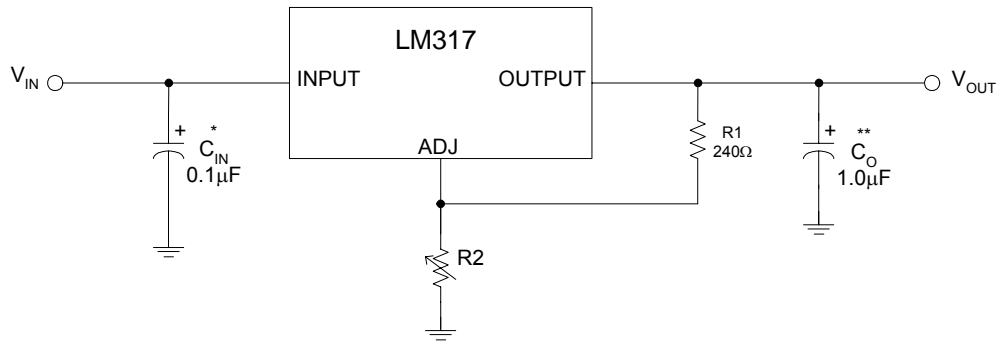

Figure 15. Load Transient Response

LM317

3-TERMINAL ADJUSTABLE VOLTAGE REGULATOR

Typical Application



* = C_{IN} is required if the regulator is located near power supply filter.

**= C_O is needed for stability and it improves transient response.

$$V_{OUT} = V_{REF} \times (1 + R2/R1) + I_{ADJ} \times R2$$

Since I_{ADJ} is controlled to less than 100 μ A, the error associated with this term is negligible in most applications.

Figure 4. Typical Application of LM317

LM317

3-TERMINAL ADJUSTABLE VOLTAGE REGULATOR

Mechanical Dimensions

SOT-223

Unit: mm(inch)

