

6

5

4

3

2

1

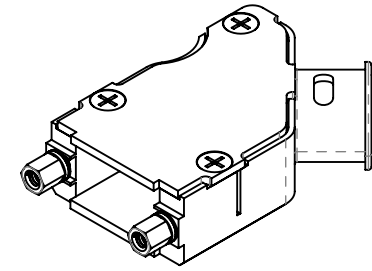
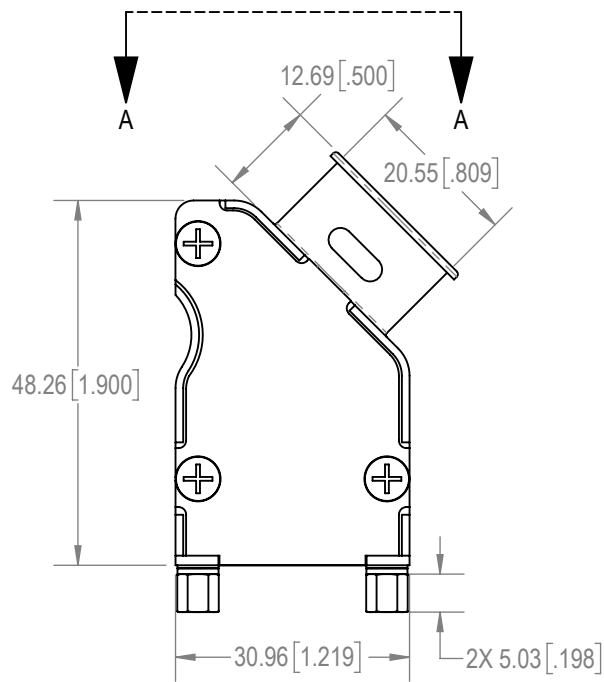

CABLE OPENING

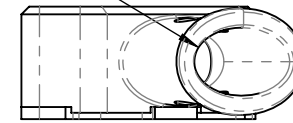

AUXILIARY A-A

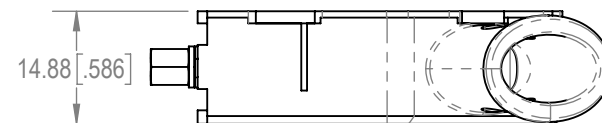
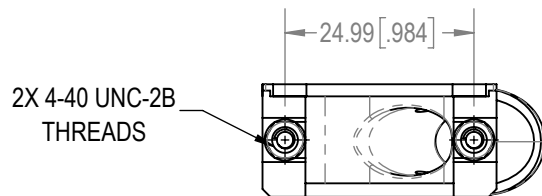
**NOTES:**

## 1. MATERIAL AND FINISHES:

HOOD AND HOOD COVER: ALUMINUM, ELECTROLESS NICKEL PLATED.

JACKSCREWS: STEEL, ZINC PLATED WITH CHROMATE SEAL.



COVER SCREWS: STEEL, NICKEL PLATE.

WASHERS: BRASS, ZINC PLATED WITH CHROMATE SEAL.

## 2. DETAILED PRODUCT, MECHANICAL AND ELECTRICAL INFORMATION IS AVAILABLE IN THE LATEST

D-SUB ACCESSORIES PRODUCT PUBLICATION AT [CONNECTPOSITRONIC.COM](http://CONNECTPOSITRONIC.COM).

## 3. HOODS ARE COMPLIANT TO THE CURRENT RoHS DIRECTIVE.

BY	SS	CHK	AP	3RD ANGLE	POSITRONIC BELIEVES THE DATA ON THE DRAWING TO BE RELIABLE. THE USER EMPLOYS SUCH INFORMATION AT HIS OWN DISCRETION AND RISK. POSITRONIC ASSUMES NO RESPONSIBILITY FOR RESULTS OBTAINED OR DAMAGES INCURRED FROM USE OF SUCH INFORMATION IN WHOLE OR IN PART.	 <b>Positronic®</b> <small>CONNECTPOSITRONIC.COM</small>
APR	AB	RELEASED DATE: 2024-01-18				
TOLERANCES				SCALE	NTS	PART NUMBER D9000AKNT20/AA
±0.03mm [.001 INCHES] FOR MALE CONTACT MATING DIAMETERS ±0.08mm [.003 INCHES] FOR CONTACT TERMINATION DIAMETERS ±0.13mm [.005 INCHES] FOR ALL OTHER DIAMETERS ±0.38mm [.015 INCHES] FOR ALL OTHER DIMENSIONS ±5° FOR ALL ANGLES DIMENSION ARE IN MILLIMETERS [INCHES]						
				TITLE D9000AKNT20/AA		
				CREATED ON: 2024-01-18	SHEET SHEET 1 OF 1	REV B

6

5

4

3

2

1