

6

5

4

3

2

1

D

D

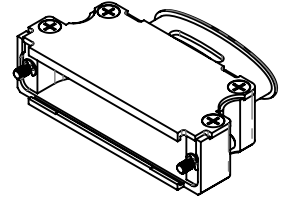
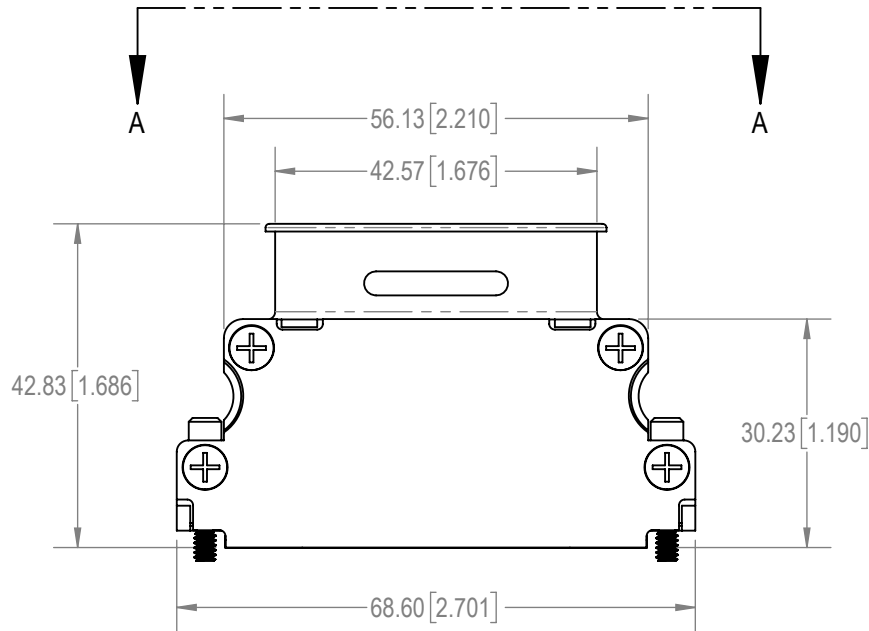

CABLE OPENING

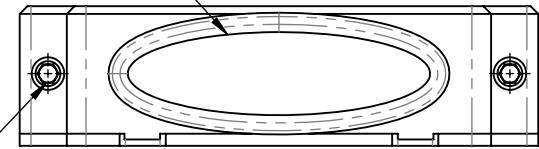
2X 2.41 [.095]
HEX SOCKET

AUXILIARY A-A

C

C

B

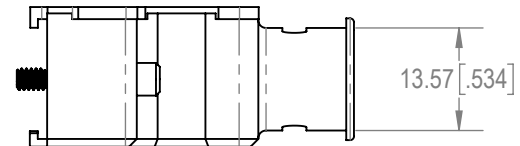
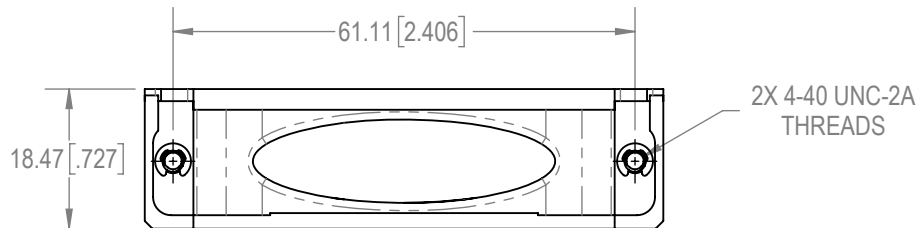

B

**NOTES:**

- MATERIAL AND FINISHES:
HOOD AND HOOD COVER: ALUMINUM, ELECTROLESS NICKEL PLATE.
JACKSCREWS: STEEL, NICKEL PLATE.
COVER SCREWS: STEEL, NICKEL PLATE.
RETAINING RINGS: STAINLESS STEEL, PASSIVATED.
- DETAILED PRODUCT, MECHANICAL AND ELECTRICAL INFORMATION IS AVAILABLE IN THE LATEST D-SUB ACCESSORIES PRODUCT PUBLICATION AT CONNECTPOSITRONIC.COM.
- HOODS ARE COMPLIANT TO THE CURRENT RoHS DIRECTIVE.

A

A

BY	SS	CHK	AP	3RD ANGLE	<small>POSITRONIC BELIEVES THE DATA ON THE DRAWING TO BE RELIABLE. THE USER EMPLOYS SUCH INFORMATION AT HIS OWN DISCRETION AND RISK. POSITRONIC ASSUMES NO RESPONSIBILITY FOR RESULTS OBTAINED OR DAMAGES INCURRED FROM USE OF SUCH INFORMATION IN WHOLE OR IN PART.</small>	 Positronic® <small>CONNECTPOSITRONIC.COM</small>
APR	AB	RELEASED DATE: 2024-01-03				
TOLERANCES				SCALE	PART NUMBER	
<small>±0.03mm [.001 INCHES] FOR MALE CONTACT MATING DIAMETERS ±0.08mm [.003 INCHES] FOR CONTACT TERMINATION DIAMETERS ±0.13mm [.005 INCHES] FOR ALL OTHER DIAMETERS ±0.38mm [.015 INCHES] FOR ALL OTHER DIMENSIONS ±5° FOR ALL ANGLES DIMENSION ARE IN MILLIMETERS [INCHES]</small>				NTS	D50000AWNE0/AA	SERIES D
				TITLE	D50000AWNE0/AA	
				CREATED ON:	SHEET	REV
				2024-01-03	SHEET 1 OF 1	C

6

5

4

3

2

1