

6

5

4

3

2

1

D

D

C

C

B

B

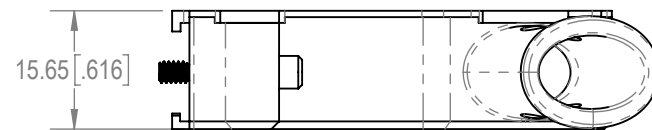
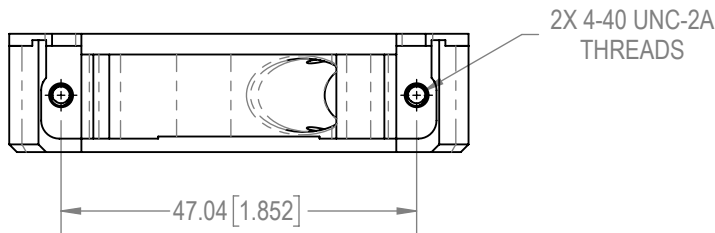
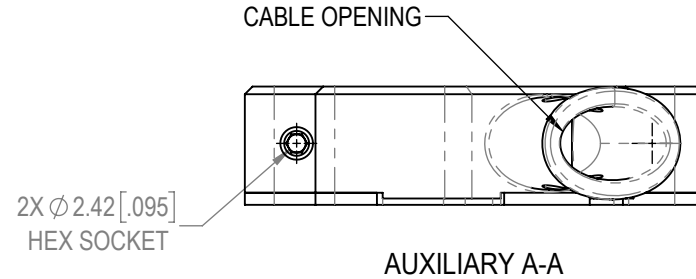
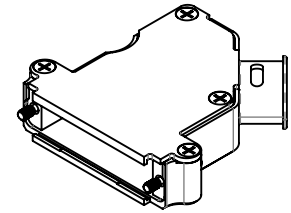
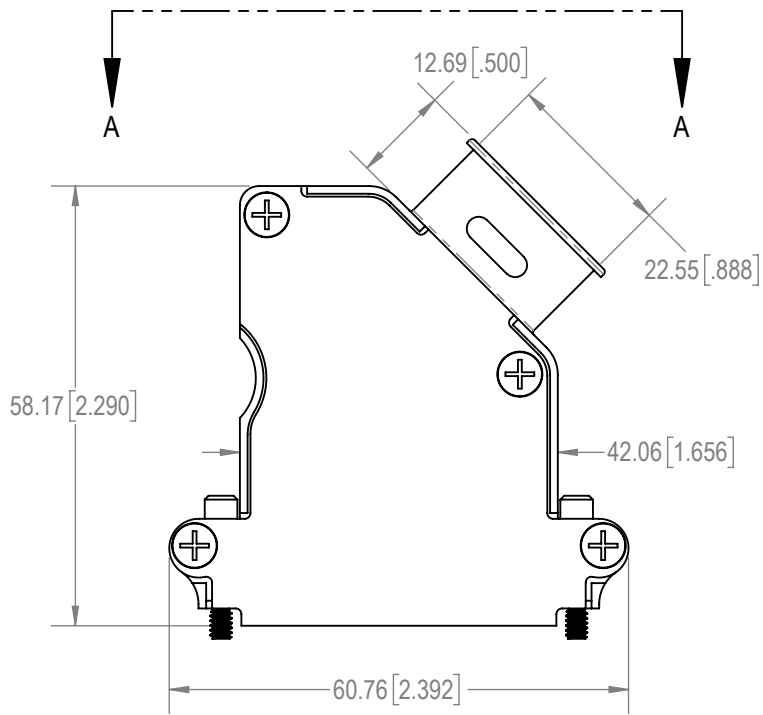

A

A



NOTES:

- MATERIAL AND FINISHES:
HOOD AND HOOD COVER: ALUMINUM, ELECTROLESS NICKEL PLATE.
JACKSCREWS: STEEL, NICKEL PLATE.
COVER SCREWS: STEEL, NICKEL PLATE.
- DETAILED PRODUCT, MECHANICAL AND ELECTRICAL INFORMATION IS AVAILABLE IN THE LATEST D-SUB ACCESSORIES PRODUCT PUBLICATION AT CONNECTPOSITRONIC.COM.
- HOODS ARE COMPLIANT TO THE CURRENT RoHS DIRECTIVE.

BY	SS	CHK	AP	3RD ANGLE	POSITRONIC BELIEVES THE DATA ON THE DRAWING TO BE RELIABLE. THE USER EMPLOYS SUCH INFORMATION AT HIS OWN DISCRETION AND RISK. POSITRONIC ASSUMES NO RESPONSIBILITY FOR RESULTS OBTAINED OR DAMAGES INCURRED FROM USE OF SUCH INFORMATION IN WHOLE OR IN PART.	 Positronic® CONNECTPOSITRONIC.COM
APR	AB	RELEASED DATE:	2024-01-18			
TOLERANCES				SCALE	NTS	PART NUMBER D25000AKNE0/AA
±0.03mm [.001 INCHES] FOR MALE CONTACT MATING DIAMETERS ±0.08mm [.003 INCHES] FOR CONTACT TERMINATION DIAMETERS ±0.13mm [.005 INCHES] FOR ALL OTHER DIAMETERS ±0.38mm [.015 INCHES] FOR ALL OTHER DIMENSIONS ±5° FOR ALL ANGLES DIMENSION ARE IN MILLIMETERS [INCHES]				TITLE		
CREATED ON:				SHEET	REV	
2024-01-18				SHEET 1 OF 1	B	

6

5

4

3

2

1