

6

5

4

3

2

1

D

D

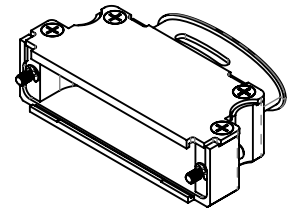

C

C

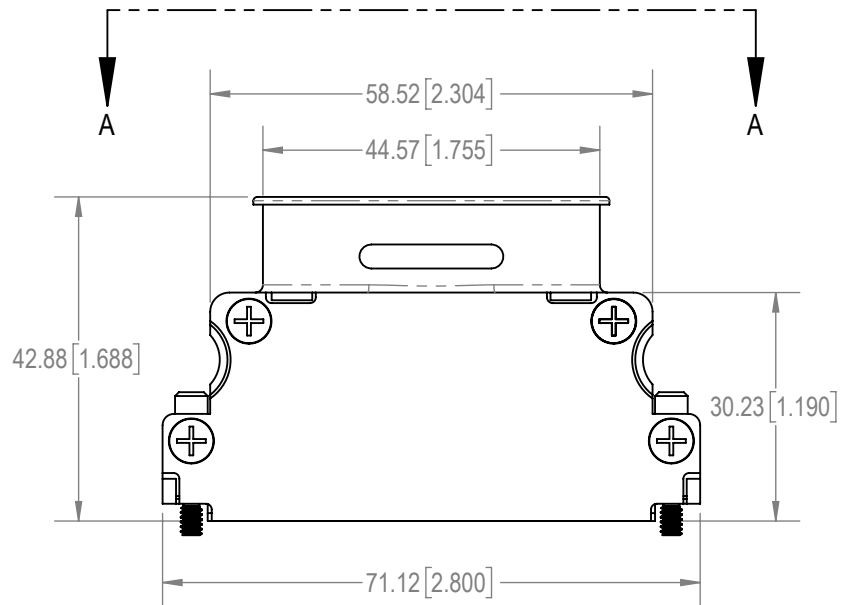

CABLE OPENING

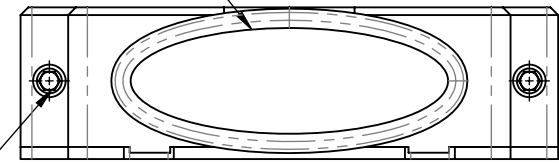
2X 2.41 [.095]
HEX SOCKET

AUXILIARY A-A

B

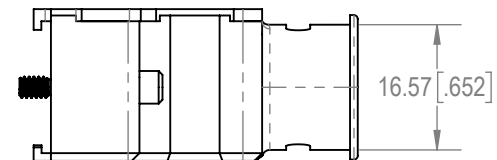
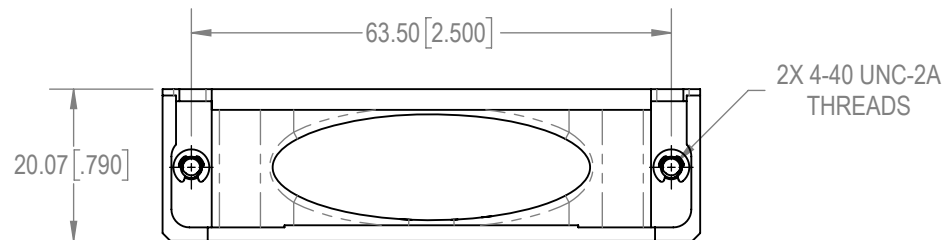

B

**NOTES:**

- MATERIAL AND FINISHES:**
HOOD AND HOOD COVER: ALUMINUM, ELECTROLESS NICKEL PLATE.
JACKSCREWS: STEEL, NICKEL PLATE.
COVER SCREWS: STEEL, NICKEL PLATE.
RETAINING RINGS: STAINLESS STEEL, PASSIVATED.
- DETAILED PRODUCT, MECHANICAL AND ELECTRICAL INFORMATION IS AVAILABLE IN THE LATEST D-SUB ACCESSORIES PRODUCT PUBLICATION AT CONNECTPOSITRONIC.COM.
- HOODS ARE COMPLIANT TO THE CURRENT RoHS DIRECTIVE.

A

A

BY	SS	CHK	AP	3RD ANGLE	POSITRONIC BELIEVES THE DATA ON THE DRAWING TO BE RELIABLE. THE USER EMPLOYS SUCH INFORMATION AT HIS OWN DISCRETION AND RISK. POSITRONIC ASSUMES NO RESPONSIBILITY FOR RESULTS OBTAINED OR DAMAGES INCURRED FROM USE OF SUCH INFORMATION IN WHOLE OR IN PART.	 Positronic® CONNECTPOSITRONIC.COM		
APR	AB	RELEASED DATE: 2024-01-03						
TOLERANCES				SCALE	PART NUMBER	SERIES		
±0.03mm [.001 INCHES] FOR MALE CONTACT MATING DIAMETERS ±0.08mm [.003 INCHES] FOR CONTACT TERMINATION DIAMETERS ±0.13mm [.005 INCHES] FOR ALL OTHER DIAMETERS ±0.38mm [.015 INCHES] FOR ALL OTHER DIMENSIONS ±5° FOR ALL ANGLES DIMENSIONS ARE IN MILLIMETERS [INCHES]				NTS			D104000AWNE0/AA	D
				TITLE			D104000AWNE0/AA	
CREATED ON:				SHEET	REV			
2024-01-03				SHEET 1 OF 1	C			

6

5

4

3

2

1