

SPECIFICATIONS

(RoHS Compliant)

Model Number: CRKU190A-E48
Part Number: 17002100A

Version: 00
Aug 31, 2023



Mechanical Drawing:

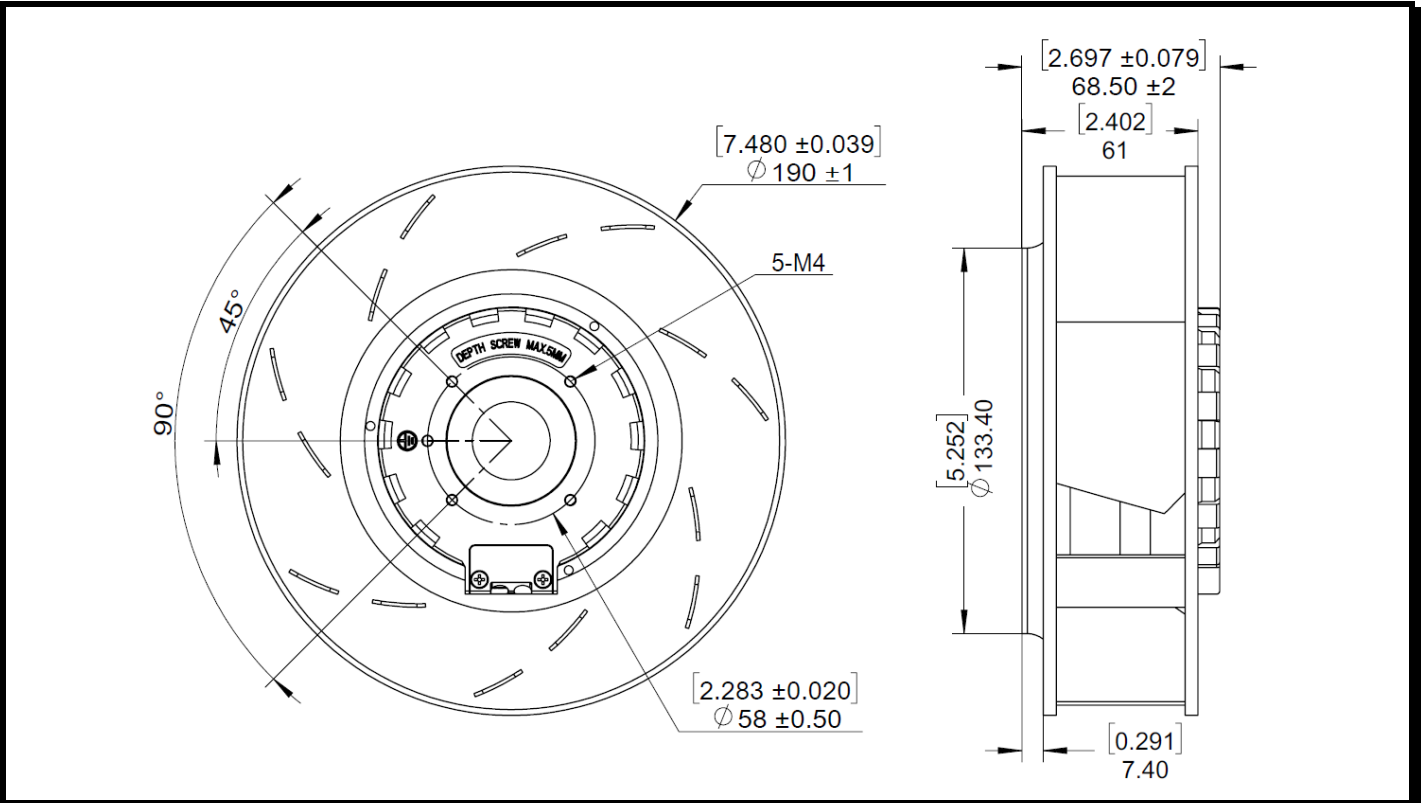

Motor:

Nominal Voltage	= 48 vdc
Operating Voltage Range	= 43.2 – 52.8 vdc
Nominal Running Current	= 1.667 amps
Max. Locked Rotor Current	= 3.0 amps
Running Power	= 80 watts
Average Speed	= 3200 RPM
Bearings	= Ball
Air Flow	= 335.1 CFM
Acoustic	= 74 dBA
Weight	= 1200g

Construction:

Venturi: Die Cast Aluminum
Propeller: Die Cast magnesium alloy, ED coating and powder coating

Life Expectancy:

This fan is designed for continuous duty life of 55,000 hours at 40°C.

Additional Features:

Brushless DC Motor
Automatic Restart Capability
Electronic Locked Rotor Protection
Polarity Protected
Operating Temperature: -10°C to 70°C
Storage Temperature: -40°C to 85°C

Agencies:

UL, CE

Termination:

450mm Cable
Red = Power(+)
Black = Return(-)

PQ Curve:

