

SPECIFICATIONS

(RoHS Compliant)

Model Number: CR2880DC48V
Part Number: 17002086A

Version: 00
Aug 31, 2023



Mechanical Drawing:

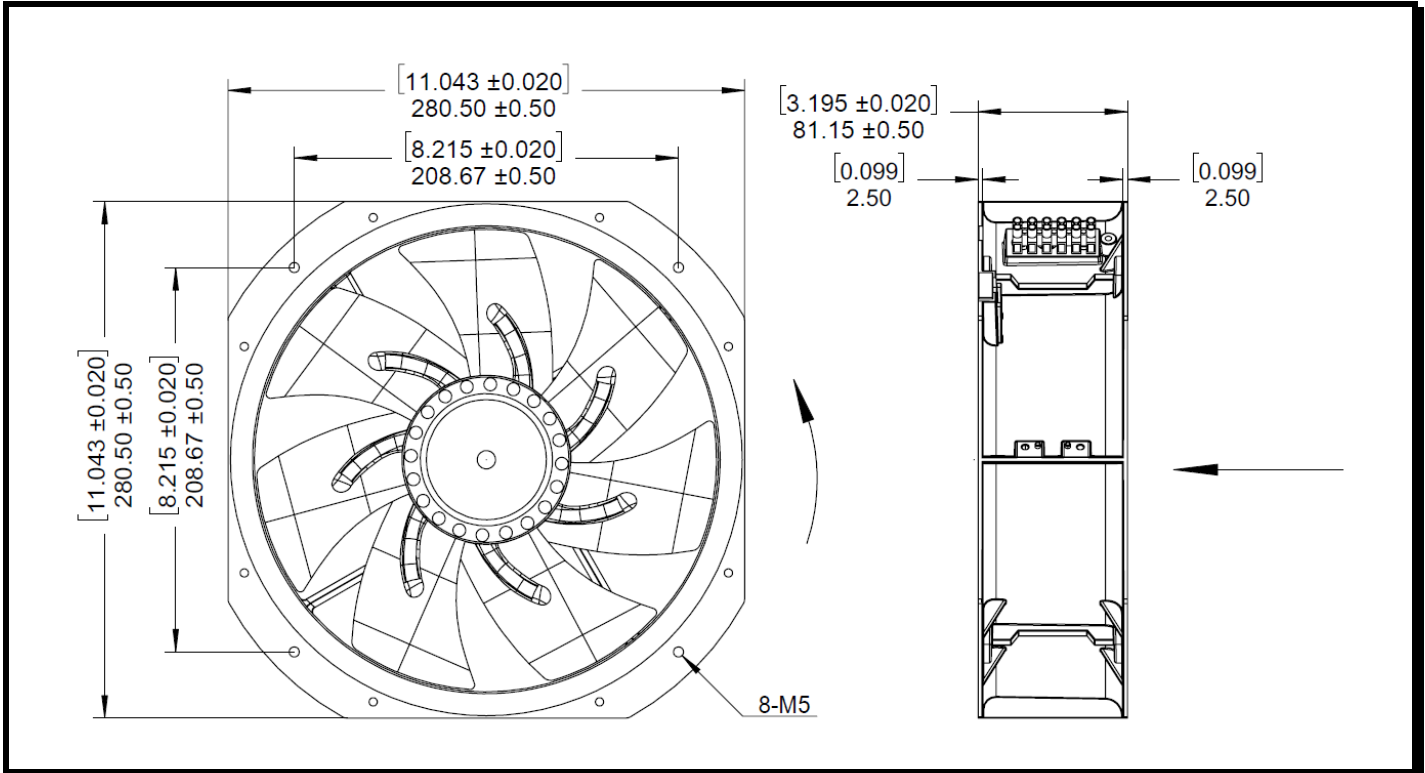

Motor:

Nominal Voltage	= 48 vdc
Operating Voltage Range	= 43.2 – 52.8 vdc
Nominal Running Current	= 2.6 amps
Max. Locked Rotor Current	= 5.0 amps
Running Power	= 124.8 watts
Average Speed	= 3000 RPM
Bearings	= Ball
Air Flow	= 1179.6 CFM
Acoustic	= 77 dBA
Weight	= 2050g

Construction:

Venturi: Die Cast magnesium alloy, ED coating and powder coating
Propeller: Die Cast magnesium alloy, ED coating and powder coating

Life Expectancy:

This fan is designed for continuous duty life of 50,000 hours at 40°C.

Additional Features:

Brushless DC Motor
Automatic Restart Capability
Electronic Locked Rotor Protection
Polarity Protected
Operating Temperature: -10°C to 70°C
Storage Temperature: -40°C to 85°C

Agencies:

UL,CE

Termination:

310 \pm 10mm , 18AWG UL1332 Leadwires
Red = Power(+)
Black = Return(-)

PQ Curve:

