

# SPECIFICATIONS

(RoHS Compliant)

**Model Number:** CR1225-LD48BPL  
**Part Number:** 17002071A

**Version:** 00  
**Aug 30, 2023**



## Mechanical Drawing:

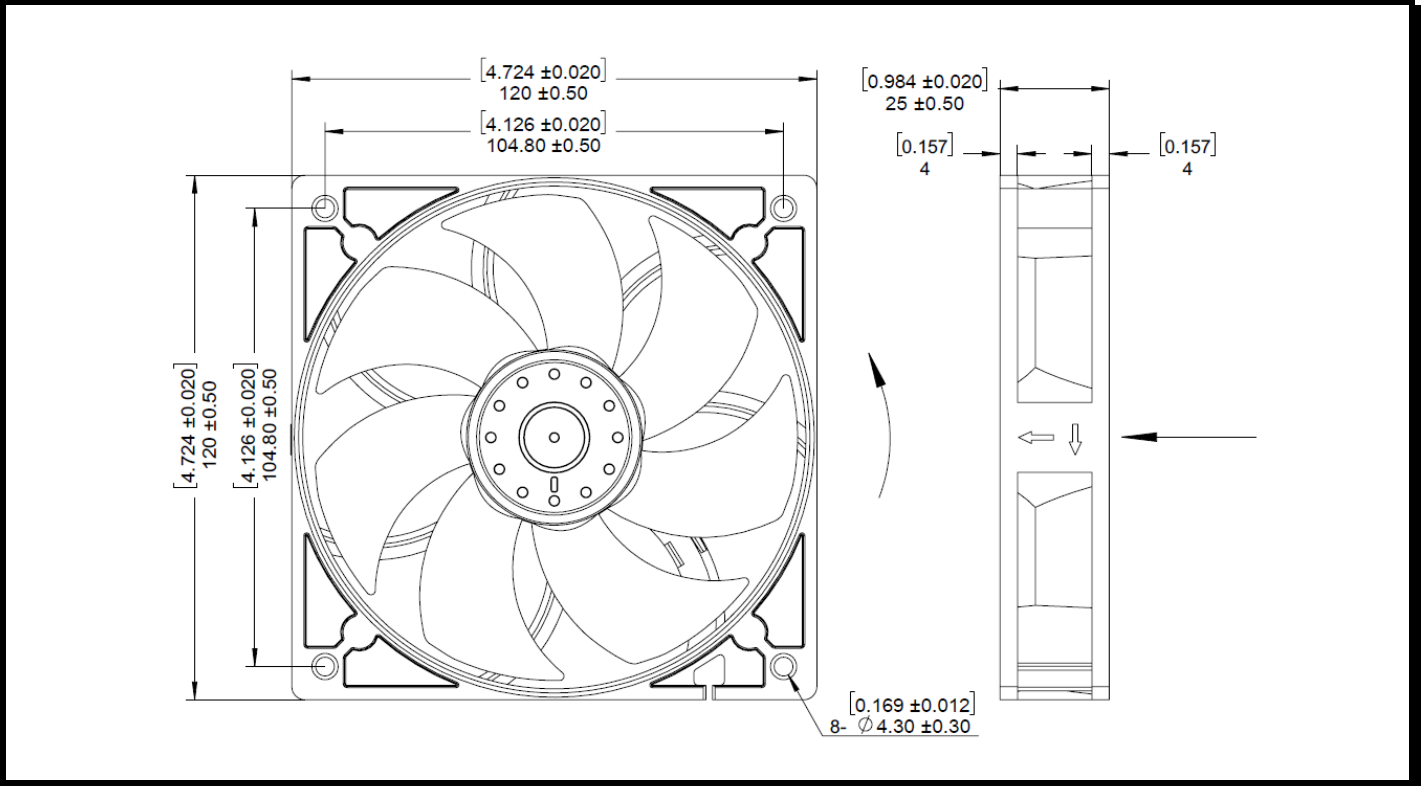

### Motor:

Nominal Voltage	= 48 vdc
Operating Voltage Range	= 43.2 – 52.8 vdc
Nominal Running Current	= 0.08 amps
Max. Locked Rotor Current	= 0.20 amps
Running Power	= 3.84 watts
Average Speed	= 3000 RPM
Bearings	= Ball
Air Flow	= 95.6 CFM
Acoustic	= 51 dBA
Weight	= 140g

### Construction:

Venturi: Plastic, Black, UL 94V-0  
Propeller: Plastic, Black, UL 94V-0

### Life Expectancy:

This fan is designed for continuous duty life of 50,000 hours at 40°C.

### Additional Features:

Brushless DC Motor  
Automatic Restart Capability  
Electronic Locked Rotor Protection  
Polarity Protected  
Operating Temperature: -10°C to 70°C  
Storage Temperature: -40°C to 85°C

### Agencies:

UL,CE

### Termination:

250±10mm , 24AWG UL1007 Leadwires  
Red = Power(+)  
Black = Return(-)

**PQ Curve:**

