

knitter switch

Professional Switches

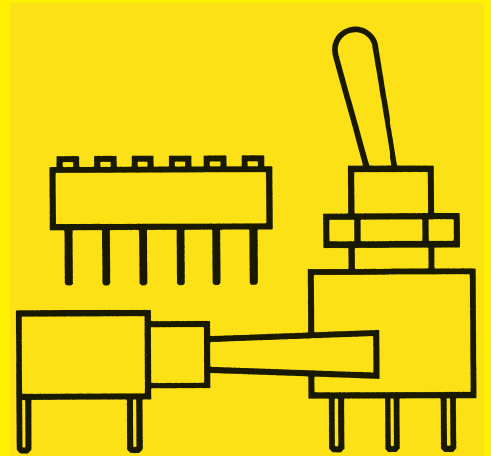

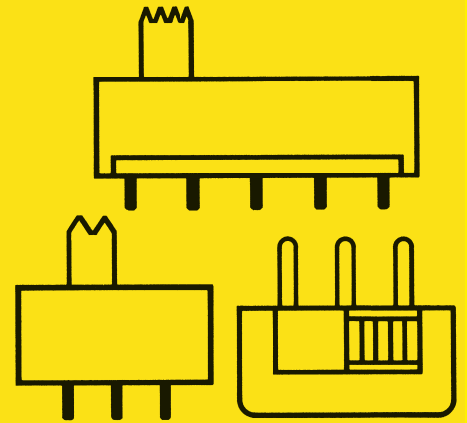





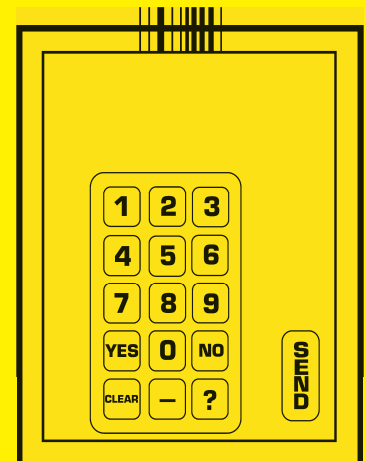

Low Cost Series



Membrane & Keypads



INDEX

	1. General Information	4
	2. Toggle Switches	7
	3. Pushbutton Switches	31
	4. Slide Switches	101
	5. Dual-in-line Switches	129
	6. Rotary Coded Switches	153
	7. Rotary Switches	169
	8. Encoder	179
	9. Micro / Snap Action Switches	193
	10. LEDs	205
	11. Membrane Keypads and Rubber Keypads	211

General Information

The catalog details are without obligation and subject to modifications after print.

Current datasheets and product change notifications can be found on www.knitter-switch.com.

This catalogue is divided by switch types: toggle switches, pushbutton switches, slide switches, dual-in-line switches, rotary coded switches, rotary switches, encoder, LED's and membranes.

The chapters include professional, semi-professional and low-cost components.

The technical specification for each series is specifically stated. Unless otherwise specified, the figures for contact rating apply for the standard version.

For several series, especially MT... and MP..., the following is available:

Standard version: silver or silver-plated contacts and terminals

Configuration B: gold-plated (over Nickel) contacts and terminals

Configuration G: gold-plated (over silver) contacts and terminals

All switches are sealed on the terminal side.

Switches for SMT as well as most series for PCB mounting are generally fully washable.

Unless otherwise specified, components for auto- (wave-) soldering are limited to pre-heat max. 60s, max. 100 °C, soldering max. 5s, max. 260 °C.

Signs and symbols:



component is UL-listed

ESD: component is ESD-resistant. Resistance is depending from switch size and is listed in the technical data

IP 67: component has an approved IP rating or is according to an IP rating

CE: our products meet all relevant regulations



all components in this catalogue are compliant with regulation 2002/95/EC



IR-reflow soldering according to JEDEC ST-020 D
(peak 260 °C, 10s max.)

Type naming/switching functions

A group of a maximum of 4 identification letters is followed by up to 4 digits (excepted membranes and some switches with specific features).

The letters are specific for the type of actuation, the digits describes certain technical features.

This is followed by the characteristic letters for the different switching functions (if there are):

	A	off	–	on	
	B	on	–	(mom)	
	C	off	–	mom	
First column is used for 1/3 pole-, second column for 2/4 pole switches.	D	N	on	–	on
For switches using same housing for 1 and 2 pole versions, only column 1 is used	E	P	on	off	on
	F	R	mom	–	on
	G	S	mom	off	mom
	H	T	mom	off	on
	EA	PA	on	on	on
		SA	mom	on	mom
		TA	mom	on	on

mom: momentary on
(mom): momentary off

For all toggle switches, a dot on the top of the switching function table indicates the switching position with the lever in the direction of the keyway or the flattened thread. The closed contacts are always opposite to the position of the lever.

For PA, SA and TA types the poles are switched separately as shown in the diagram below:

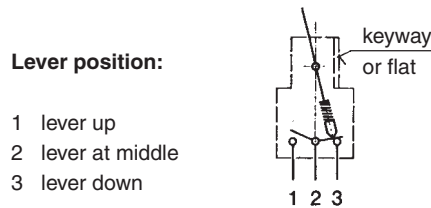

DPDT

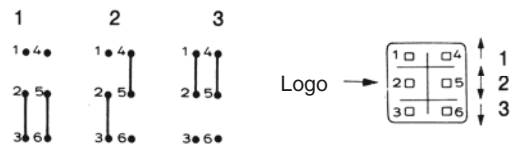

3PDT

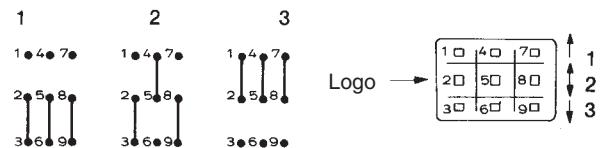

A connection between terminals 3 and 5 forms a one-pole three-position switch.



4PDT

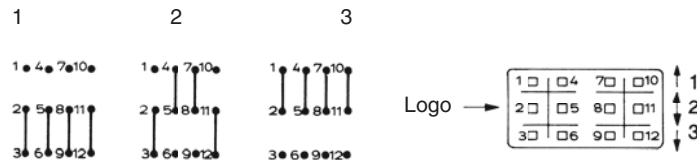

Connections between terminals 3 and 5 and 8 and 12 form a two-pole three-position switch.



2

Toggle Switches

2.1 Miniature Toggle Switches



General		8– 9
Series STM	with short lever	10–11
Series MTA		12–13
Series MTE	waterproof IP 67	14–15
Series MTL	with locking lever	16–17
Series MTG	mustang type	18–19
Series MTW	mustang type/IP 67	20
Series MZME	ESD proof, waterproof IP 67	21

2.2 Subminiature Toggle Switches



Series ATE		22–24
Series SST	SMD / waterproof IP 67	25
Series TST	low-cost/ESD proof, waterproof IP 67	26–27

2.3 Microminiature Toggle Switches



Series FT	ESD proof	28–29
-----------	-----------	-------

Miniature Toggle Switches

Available for miniature toggle switches series MT./ST.
and also for miniature pushbutton switches series MP.

Solder tags:

Series MT./MP.



PC terminals:

- PC

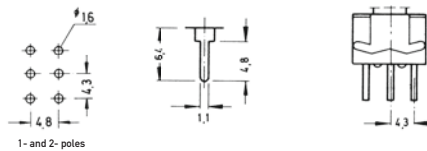

horizontal actuation on PCB*

- RA

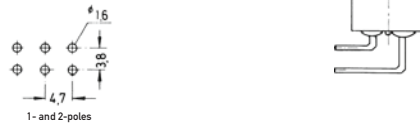

vertical actuation on PCB*

- VM



* Series ST./SP. only

Standard switches with RA and VM are without thread. Special versions upon request.

Partly non-stock items; minimum quantity and delivery time on request.

Miniature Toggle Switches

Standard levers:

Series MTA

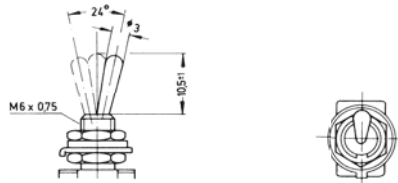

waterproof IP 67
Series MTE

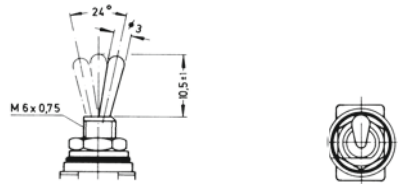

Special levers:

short
Series MTM

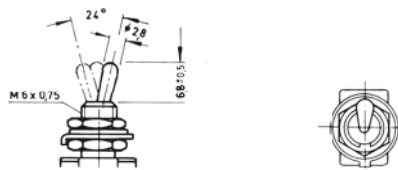

flat, with decorative nut
Series MTF

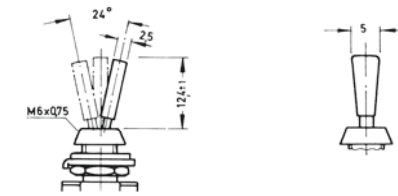

Mustang levers:

Series MTG

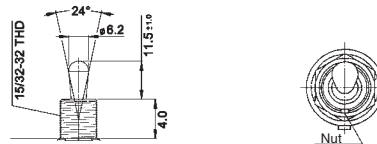

long, waterproof IP 67
Series MTW

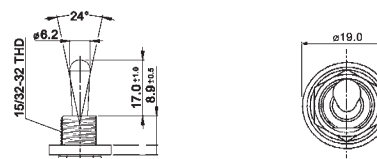

Locking lever:

Series MTL

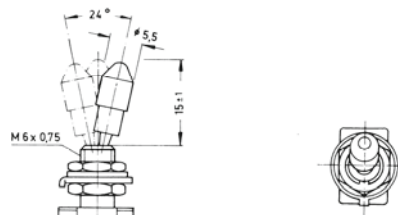

Miniature Toggle Switches for horizontal mounting, without thread



Specifications:

Contact rating:	250 V AC, 3 A / 125 V AC, 6 A 30 V DC, 4 A / 12 V DC, 5 A 6 V DC, 6 A
Contact resistance:	< 10 mΩ
Insulation resistance:	> 1000 MΩ at 500 V DC
Dielectric strength:	1500 V, 50 Hz for the duration of 1 minute
Operating temperature:	- 20 °C to + 80 °C
Mechanical life:	minimum 100 000 operations
Contacts:	coin silver (common contact copper alloy, silver-plated)
Terminals:	PC terminals, copper alloy silver-plated
Material:	case: diallyle-phthalate, meets UL 94 V-0, green lever: chromium-plated, metal parts: nickel-plated
Mounting:	on pc-board, horizontal mounting
Soldering conditions:	auto-soldering – max.: 5 sec, 270 °C

Models:

Switching functions

S P D T

STM 106 D – RA	on	–	on
STM 106 E – RA	on	off	on
STM 106 F – RA	mom	–	on
STM 106 G – RA	mom	off	mom
STM 106 H – RA	mom	off	on

D P D T

STM 206 N – RA	on	–	on
STM 206 P – RA	on	off	on
STM 206 R – RA	mom	–	on
STM 206 S – RA	mom	off	mom
STM 206 T – RA	mom	off	on

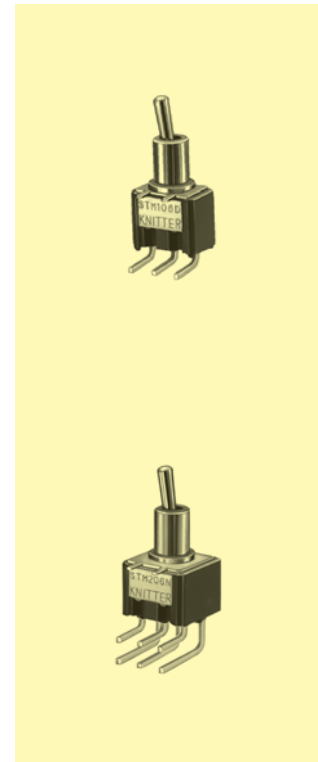
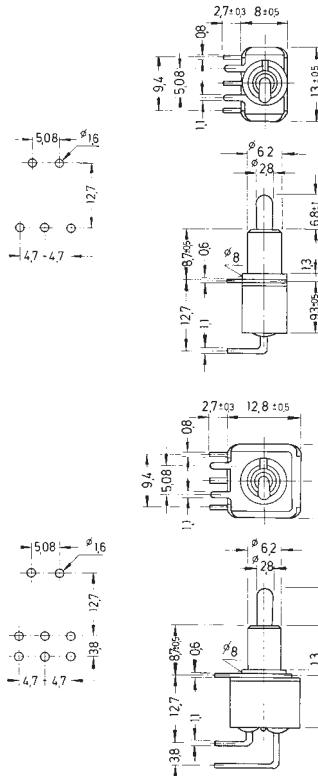



Miniature Toggle Switches for vertical mounting, without thread

Specifications:

Contact rating:	250 V AC, 3 A / 125 V AC, 6 A 30 V DC, 4 A / 12 V DC, 5 A 6 V DC, 6 A
Contact resistance:	< 10 mΩ
Insulation resistance:	> 1000 MΩ at 500 V DC
Dielectric strength:	1500 V, 50 Hz for the duration of 1 minute
Operating temperature:	- 20 °C to + 80 °C
Mechanical life:	minimum 100 000 operations
Contacts:	coin silver (common contact copper alloy, silver-plated)
Terminals:	PC terminals, copper alloy silver-plated
Material:	case: diallyle-phthalate, meets UL 94 V-0, green lever: chromium-plated, metal parts: nickel-plated
Mounting:	on pc-board, vertical mounting
Soldering conditions:	auto-soldering – max.: 5 sec, 270 °C

Models:

Switching functions

S P D T

STM 106 D – VM
STM 106 E – VM
STM 106 F – VM
STM 106 G – VM
STM 106 H – VM

●	on	–	on
	on	off	on
	mom	–	on
	mom	off	mom
	mom	off	on

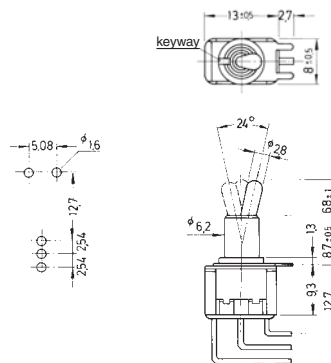

D P D T

STM 206 N – VM
STM 206 P – VM
STM 206 R – VM
STM 206 S – VM
STM 206 T – VM

	on	–	on
	on	off	on
	mom	–	on
	mom	off	mom
	mom	off	on

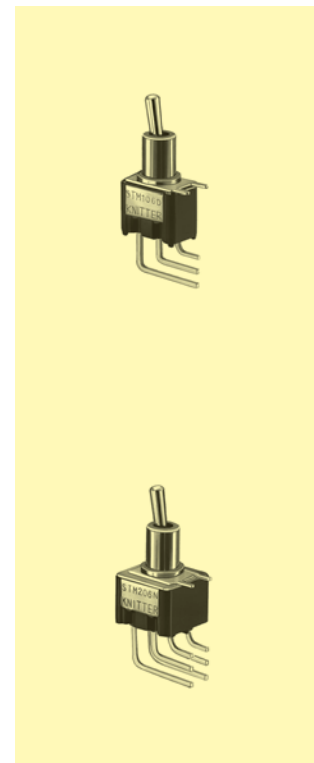
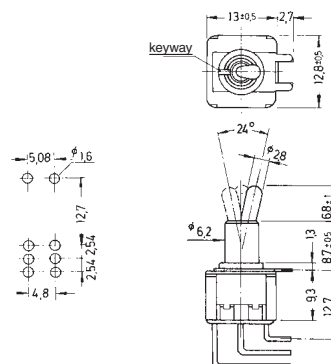

Miniature Toggle Switches



Specifications:

Contact rating:	250 V AC, 3 A / 125 V AC, 6 A 30 V DC, 4 A / 12 V DC, 5 A 6 V DC, 6 A
Contact resistance:	< 10 mΩ
Insulation resistance:	> 1000 MΩ at 500 V DC
Dielectric strength:	1500 V, 50 Hz for the duration of 1 minute
Operating temperature:	- 45 °C to + 140 °C
Mechanical life:	minimum 300 000 operations
Contacts:	coin silver (common contact copper alloy, silver-plated) also available gold-plated, version B and G (see page 4)
Terminals:	solder tags, copper alloy silver-plated further terminal versions see page 8
Material:	case: diallyle-phthalate, meets UL 94 V-0, black lever: chromium-plated, metal parts: nickel-plated
Mounting:	bushing M 6 x 0,75 with locking plate, key 9 mm
Soldering conditions:	hand-soldering – max.: 60 W, 3 sec, 420 °C auto-soldering – max.: 5 sec, 270 °C

Accessories:

Knurled nut, nickel-plated

M 6 x 0,75, Ø 8 mm R 675



Plastic caps (height 11,5 mm)

orange	C 1103
blue	C 1104
black	C 1105
green	C 1106
grey	C 1107
yellow	C 1108
red	C 1109
white	C 1110



Waterproof sealing caps (height 14,3 mm)

black	ET 102
green	ET 106
yellow	ET 108
red	ET 109



Waterproof sealing cap with mounting screw

Special levers:

Miniature toggle switches with short lever

Series MTM

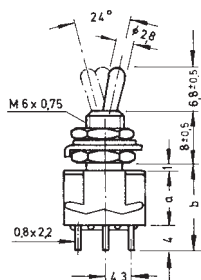

Miniature toggle switches with flat lever and special decorative nut

Series MTF

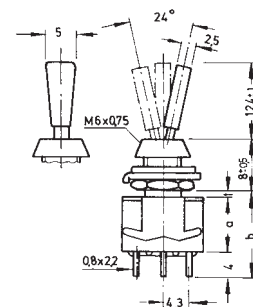



Miniature Toggle Switches

Models: Switching functions

SPDT



MTA 106 D	on	-	on
MTA 106 E	on	off	on
MTA 106 F	mom	-	on
MTA 106 G	mom	off	mom
MTA 106 H	mom	off	on

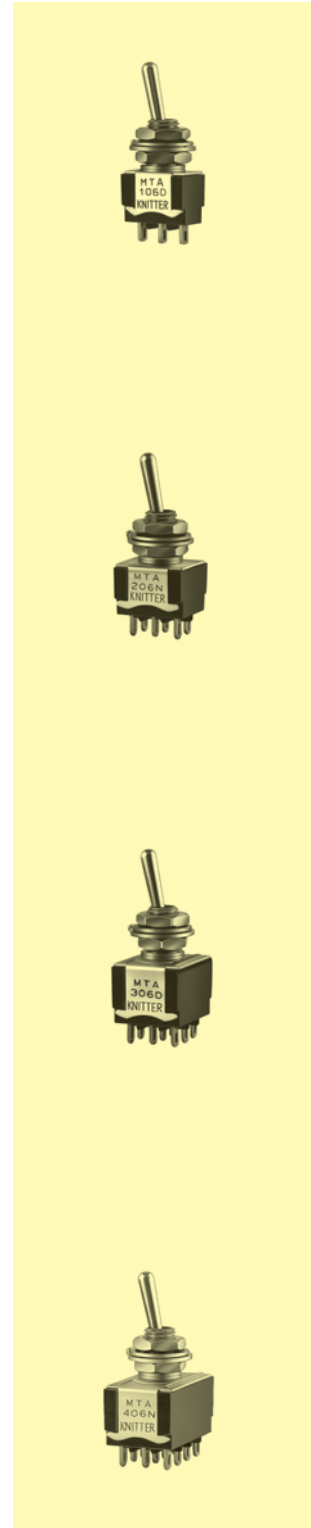
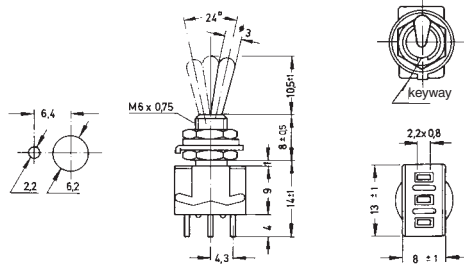

2

DPDT

MTA 206 N	on	-	on
MTA 206 P	on	off	on
MTA 206 R	mom	-	on
MTA 206 S	mom	off	mom
MTA 206 T	mom	off	on
MTA 206 PA	on	on	on
MTA 206 SA	mom	on	mom
MTA 206 TA	mom	on	on

measures: a = 9, b = 14 ± 1

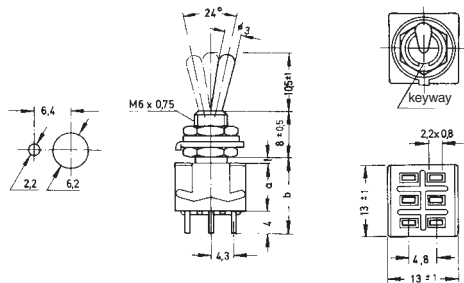

3PDT

MTA 306 D	on	-	on
MTA 306 E	on	off	on
MTA 306 F	mom	-	on
MTA 306 G	mom	off	mom
MTA 306 H	mom	off	on
MTA 306 EA*	on	on	on

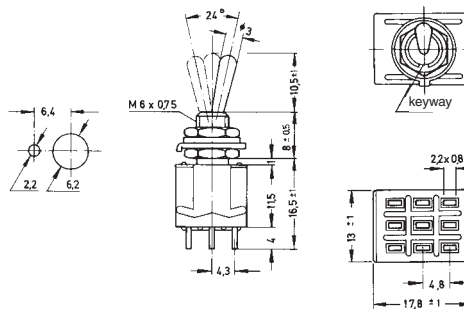

4PDT

MTA 406 N	on	-	on
MTA 406 P	on	off	on
MTA 406 R	mom	-	on
MTA 406 S	mom	off	mom
MTA 406 T	mom	off	on
MTA 406 PA	on	on	on
MTA 406 SA	mom	on	mom
MTA 406 TA	mom	on	on

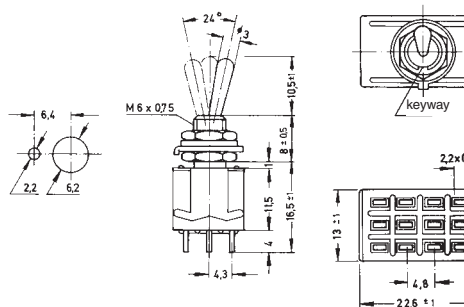

* Non-stock item; minimum quantity and delivery time on request.

Specifications:

Contact rating:	250 V AC, 3 A / 125 V AC, 6 A 30 V DC, 4 A / 12 V DC, 5 A 6 V DC, 6 A
Contact resistance:	< 10 mΩ
Insulation resistance:	> 1000 MΩ at 500 V DC
Dielectric strength:	1500 V, 50 Hz for the duration of 1 minute
Operating temperature:	– 45 °C to + 140 °C
Mechanical life:	minimum 100 000 operations
Contacts:	coin silver (common contact copper alloy, silver-plated) also available gold-plated, version B and G (see page 4)
Terminals:	solder tags, copper alloy silver-plated further terminal versions see page 8
Protection:	30 minutes at 1 m water column; IP 67
Sealing:	neoprene O-rings between toggle/bushing and bushing/panel
Material:	case: diallyle-phthalate, meets UL 94 V–0, black lever: chromium-plated, metal parts: nickel-plated
Mounting:	bushing M 6 x 0,75 locking through flat bush, key 9 mm
Soldering conditions:	hand-soldering – max.: 60 W, 3 sec, 420 °C auto-soldering – max.: 5 sec, 270 °C

Accessories:

Plastic caps (height 11,5 mm)

orange	C 1103
blue	C 1104
black	C 1105
green	C 1106
grey	C 1107
yellow	C 1108
red	C 1109
white	C 1110





Miniature Toggle Switches waterproof

Models: Switching functions

SPDT

MTE 106 D	on	-	on
MTE 106 E	on	off	on
MTE 106 F	mom	-	on
MTE 106 G	mom	off	mom
MTE 106 H*	mom	off	on

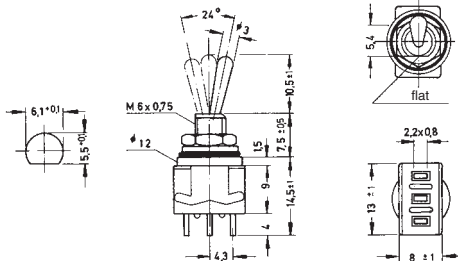

DPDT

MTE 206 N	on	-	on
MTE 206 P	on	off	on
MTE 206 R	mom	-	on
MTE 206 S	mom	off	mom
MTE 206 T	mom	off	on
MTE 206 PA	on	on	on
MTE 206 SA*	mom	on	mom
MTE 206 TA*	mom	on	on

measures: a = 9, b = 14,5±1

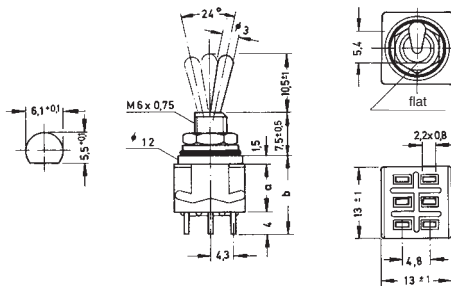

3PDT

MTE 306 D	on	-	on
MTE 306 E	on	off	on
MTE 306 F*	mom	-	on
MTE 306 G*	mom	off	mom
MTE 306 H*	mom	off	on

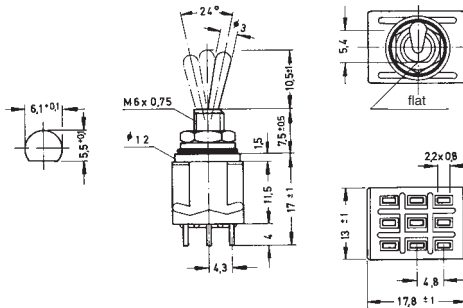

4PDT

MTE 406 N	on	-	on
MTE 406 P	on	off	on
MTE 406 R*	mom	-	on
MTE 406 S*	mom	off	mom
MTE 406 T*	mom	off	on
MTE 406 PA*	on	on	on
MTE 406 SA*	mom	on	mom
MTE 406 TA*	mom	on	on

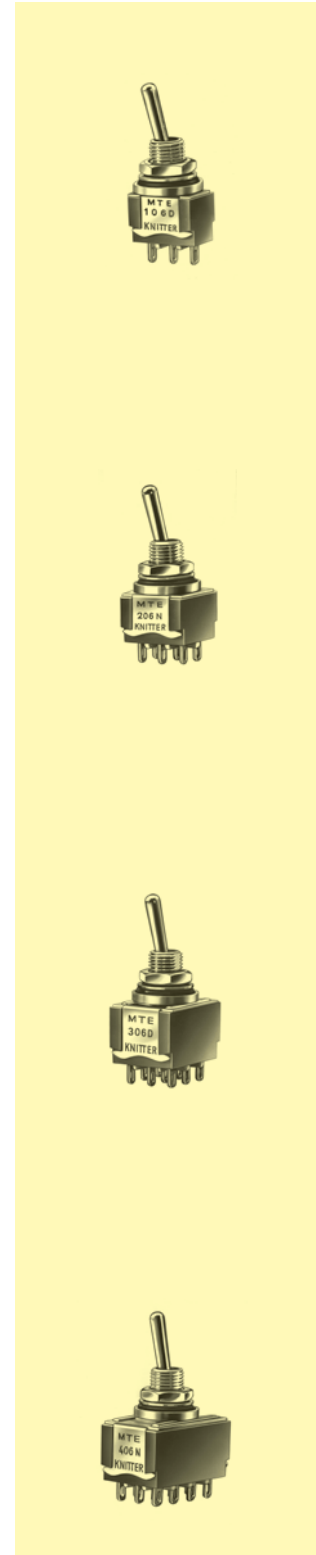
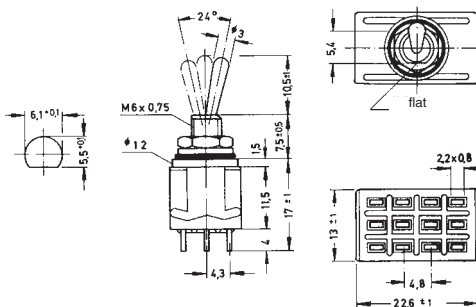

* Non-stock item; minimum quantity and delivery time on request.

Miniature Toggle Switches with locking lever



Specifications:

Contact rating:	250 V AC, 3 A / 125 V AC, 6 A 30 V DC, 4 A / 12 V DC, 5 A 6 V DC, 6 A
Contact resistance:	< 10 mΩ
Insulation resistance:	> 1000 MΩ at 500 V DC
Dielectric strength:	1500 V, 50 Hz for the duration of 1 minute
Operating temperature:	- 45 °C to + 140 °C
Mechanical life:	minimum 300 000 operations
Contacts:	coin silver (common contact copper alloy, silver-plated) also available gold-plated, version B and G (see page 4)
Terminals:	solder tags, copper alloy silver-plated
Material:	case: diallyle-phthalate, meets UL 94 V-0, black lever: chromium-plated, metal parts: nickel-plated
Mounting:	bushing M 6 x 0,75, with locking plate, key 9 mm, tightening torque 49 Ncm max.
Soldering conditions:	hand-soldering – max.: 60 W, 3 sec, 420 °C auto-soldering – max.: 5 sec, 270 °C

Accessories:

Standard version: lever and cap anodized aluminium.
On request, caps are available in the following colours:

blue	KL 104
black	KL 105
red	KL 109
silver	KL 110

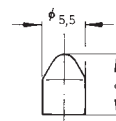



Miniature Toggle Switches with locking lever

Models

Switching functions

SPDT



MTL 106 D

on - on

MTL 106 E

on off on

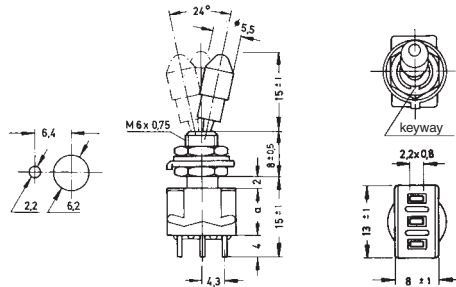

DPDT

MTL 206 N

on - on

MTL 206 P

on off on

measures: a = 9, b = 15 ± 1

MTL 206 PA

on on on

measures: a = 11,5, b = 17,5 ± 1

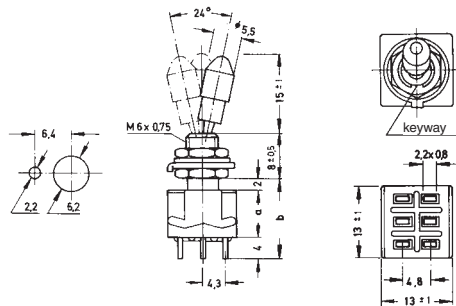

3PDT

MTL 306 D

on - on

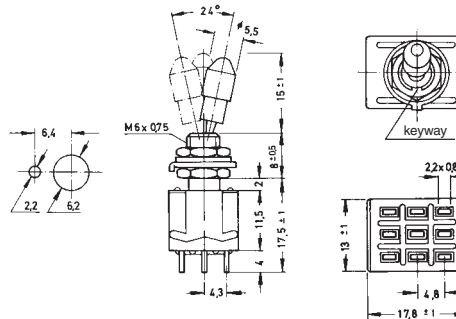

4PDT

MTL 406 N

on - on

MTL 406 P*

on off on

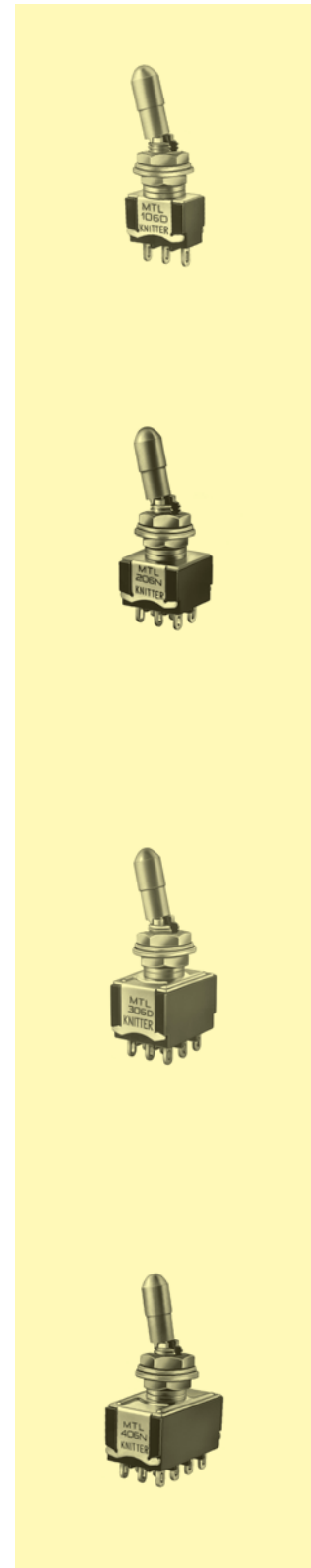
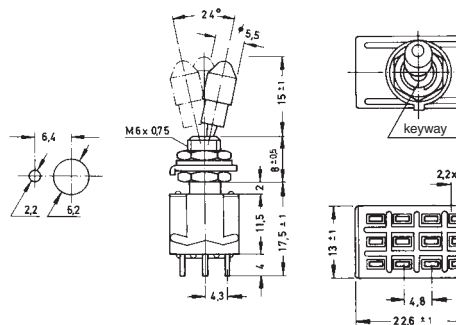

* Non-stock item; minimum quantity and delivery time on request.

Mustang Toggle Switches



Specifications:

Contact rating:	250 V AC, 3 A / 125 V AC, 6 A 30 V DC, 4 A / 12 V DC, 5 A 6 V DC, 6 A
Contact resistance:	< 20 mΩ
Insulation resistance:	> 1000 MΩ at 500 V DC
Dielectric strength:	1500 V, 50 Hz for the duration of 1 minute
Operating temperature:	- 45 °C to + 140 °C
Mechanical life:	minimum 200 000 operations (100 000 cycles for SA and TA)
Contacts:	coin silver (common contact copper alloy, silver-plated) also available gold-plated version B and G (see page 4)
Terminals:	solder tags, copper alloy silver-plated further terminal versions see page 8
Material:	case: diallyle-phthalate, meets UL 94 V-0, green lever: chromium-plated, metal parts: nickel-plated
Mounting:	bushing 15/32-32 THD with locking plate (M 12 x 0,75), key 14 mm
Soldering conditions:	hand-soldering – max.: 60 W, 3 sec, 420 °C auto-soldering – max.: 5 sec, 270 °C

Accessories:

Plastic caps (height 12,7 mm)

orange	C 2103
blue	C 2104
black	C 2105
green	C 2106
grey	C 2107
yellow	C 2108
red	C 2109
white	C 2110



Waterproof sealing cap (height 21,4 mm)

grey	ET 307
------	--------



Waterproof sealing cap (height 11 mm)

grey	ET 507 Z
------	----------





Mustang Toggle Switches

Models: Switching functions

SPDT



MTG 106 D	on	-	on
MTG 106 E	on	off	on
MTG 106 F	mom	-	on
MTG 106 G	mom	off	mom
MTG 106 H	mom	off	on

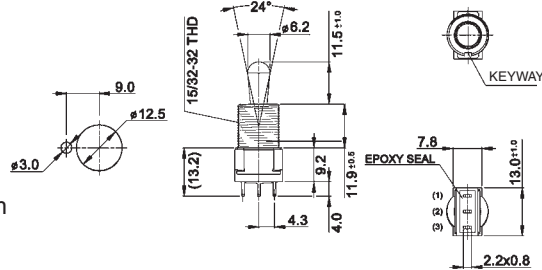

DPDT

MTG 206 N	on	-	on
MTG 206 P	on	off	on
MTG 206 R	mom	-	on
MTG 206 S	mom	off	mom
MTG 206 T	mom	off	on

measures: a = 9, b = 13 ± 1

MTG 206 PA*	on	on	on
MTG 206 SA*	mom	on	mom
MTG 206 TA*	mom	on	on

measures: a = 11,5, b = 15,5 ± 1

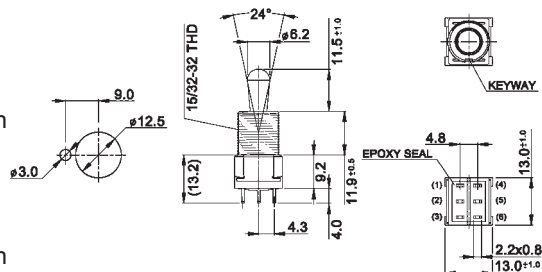

3PDT

MTG 306 D	on	-	on
MTG 306 E*	on	off	on
MTG 306 F*	mom	-	on
MTG 306 G*	mom	off	mom
MTG 306 H*	mom	off	on

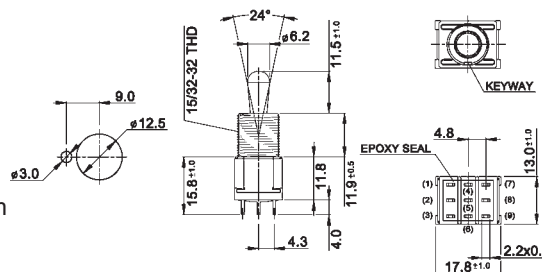

4PDT

MTG 406 N	on	-	on
MTG 406 P*	on	off	on
MTG 406 R*	mom	-	on
MTG 406 S*	mom	off	mom
MTG 406 T*	mom	off	on
MTG 406 PA*	on	on	on
MTG 406 SA*	mom	on	mom
MTG 406 TA*	mom	on	on

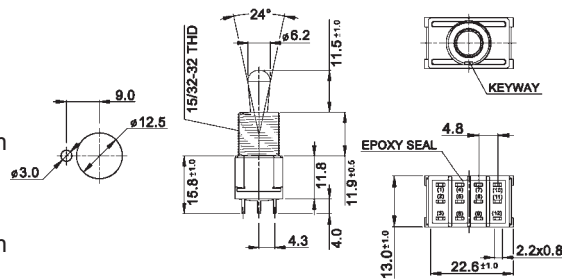

* Non-stock item; minimum quantity and delivery time on request.

Mustang Toggle Switches waterproof



Specifications:

Contact rating:	250 V AC, 3 A / 125 V AC, 6 A 30 V DC, 4 A / 12 V DC, 5 A 6 V DC, 6 A
Contact resistance:	< 20 mΩ
Insulation resistance:	> 1000 MΩ at 500 V DC
Dielectric strength:	1500 V, 50 Hz for the duration of 1 minute
Operating temperature:	- 45 °C to + 140 °C
Mechanical life:	minimum 100 000 operations
Contacts:	coin silver (common contact copper alloy, silver-plated) also available gold-plated version B and G (see page 4)
Terminals:	solder tags, copper alloy silver-plated
Protection:	IP 67
Sealing:	neoprene O-rings between toggle/bushing and bushing/panel
Material:	case: diallyle-phthalate, meets UL 94 V-0, green lever: chromium-plated, metal parts: nickel-plated
Mounting:	bushing 15/32-32 THD locking through flat bush, key 14 mm
Soldering conditions:	hand-soldering – max.: 60 W, 3 sec, 420 °C auto-soldering – max.: 5 sec, 270 °C

Models: Switching functions

SPDT

MTW 106 D	on	–	on
MTW 106 E	on	off	on
MTW 106 F	mom	–	on
MTW 106 G	mom	off	mom
MTW 106 H	mom	off	on

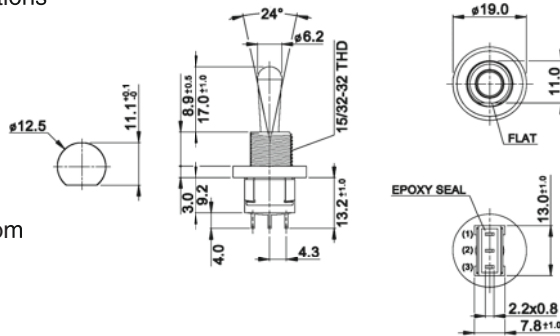

DPDT

MTW 206 N	on	–	on
MTW 206 P	on	off	on
MTW 206 R	mom	–	on
MTW 206 S	mom	off	mom
MTW 206 T	mom	off	on
MTW 206 PA	on	on	on

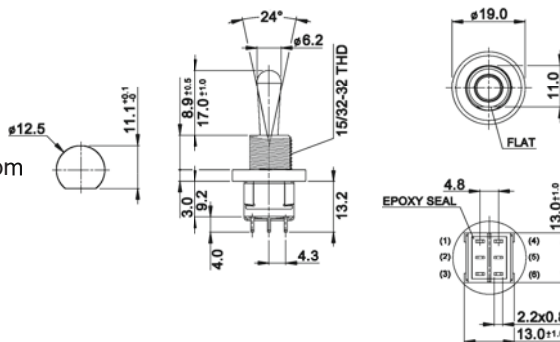

Accessories:

Waterproof sealing cap (height 11 mm)
grey ET 507 Z



Miniature Toggle Switches ESD proof

2

Specifications:

Contact rating:	20 V AC, 0,4 VA
Contact resistance:	< 10 mΩ
Insulation resistance:	> 1000 MΩ
Dielectric strength:	1000 V, 50 Hz for the duration of 1 minute
Operating temperature:	- 30 °C to + 85 °C
Mechanical life:	minimum 30 000 operations
Contacts:	gold-plated over nickel barrier
Terminals:	solder tags or PC terminals
Material:	case: PA/PES meets UL 94 V-0, waterproof lever: PA meets UL 94 V-0, waterproof
Protection:	IP 67
Mounting:	bushing 1/4" (6,35 mm), with locking ring or on pc-board
Soldering conditions:	hand-soldering – max.: 5 sec, 350 °C auto-soldering – max.: 10 sec, 260 °C
ESD resistance:	> 8 kV (between lever and terminals)

Models:

Switching positions: the closed contacts are opposite to the lever position

washable

SPDT

MZME 1 DB-ESD

on - on

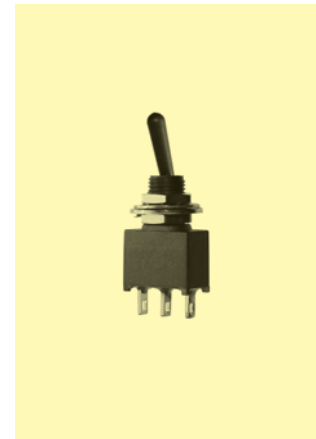
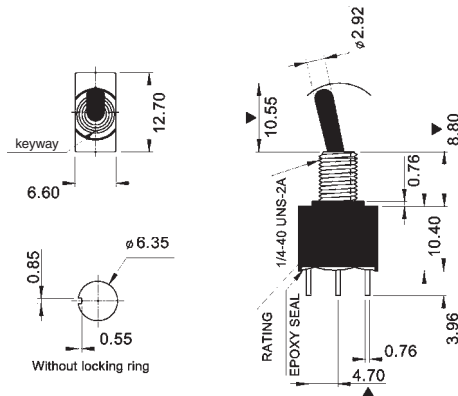

SPDT

MZME 1 DB-PC-ESD

on - on

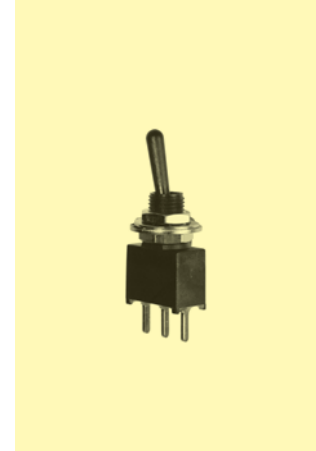
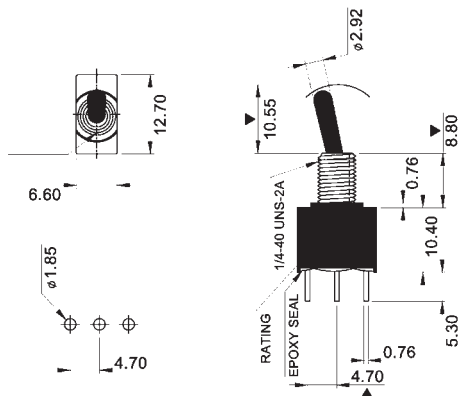

Subminiature Toggle Switches



Specifications:

Contact rating:	max. 48 V AC/DC, 0,4 VA / max. 50 mA min. 20 mV AC/DC, 1 μ A
Contact resistance:	< 50 m Ω
Insulation resistance:	> 500 M Ω at 250 V DC
Dielectric strength:	500 V, 50 Hz for the duration of 1 minute
Operating temperature:	- 20 °C to + 80 °C
Mechanical life:	minimum 60 000 operations
Contacts:	phosphor bronze gold-plated over nickel barrier
Terminals:	PC terminals, crimped phosphor bronze gold-plated over nickel barrier
Material:	case: PBT, meets UL 94 V-0, washable metal parts: nickel-plated brass
Mounting:	on pc-board
Soldering conditions:	auto-soldering – max.: 5 sec \pm 1 sec., 260 °C \pm 5 °C

Accessories:

Plastic caps	Order number
black	C 3105
green	C 3106
grey	C 3107
yellow	C 3108
red	C 3109
white	C 3110

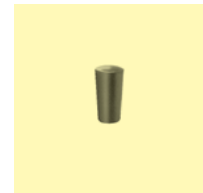
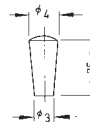

Supporting bracket for	ATE 1.	ATE 2.
Order number	AZ 0001	AZ 0005

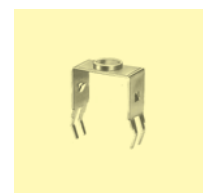
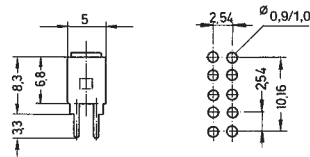
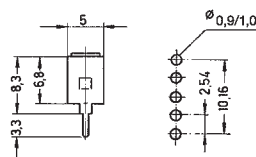



Subminiature Toggle Switches

Models:

Switching functions:
Switching functions F/H/R/T:

the closed contacts are opposite to the lever position;
when looking at the brand name on the right hand side

washable

SPDT

ATE 1 D	on	-	on
ATE 1 E	on	off	on
ATE 1 F	mom	-	on
ATE 1 G	mom	off	mom
ATE 1 H	mom	off	on

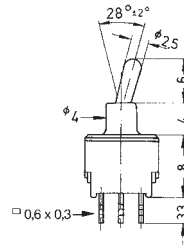
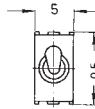
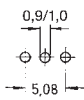

DPDT

ATE 2 D	on	-	on
ATE 2 E	on	off	on
ATE 2 F	mom	-	on
ATE 2 G	mom	off	mom
ATE 2 H	mom	off	on

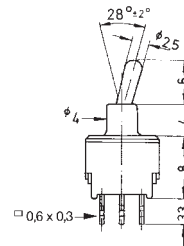
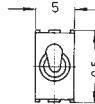
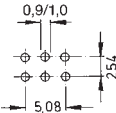

DPDT

ATE 2 N	on	-	on
ATE 2 P*	on	off	on
ATE 2 R*	mom	-	on
ATE 2 S*	mom	off	mom
ATE 2 T*	mom	off	on

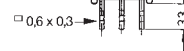
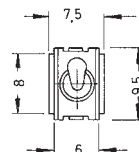
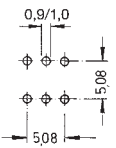

SPDT

ATE 1 D - RA	on	-	on
ATE 1 E - RA	on	off	on
ATE 1 F - RA	mom	-	on
ATE 1 G - RA	mom	off	mom
ATE 1 H - RA	mom	off	on

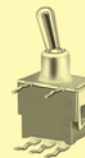
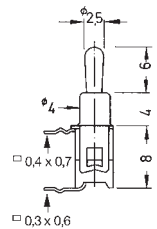
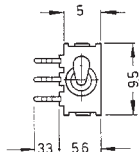
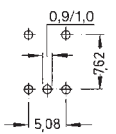

DPDT

ATE 2 D - RA	on	-	on
ATE 2 E - RA	on	off	on
ATE 2 F - RA	mom	-	on
ATE 2 G - RA	mom	off	mom
ATE 2 H - RA	mom	off	on

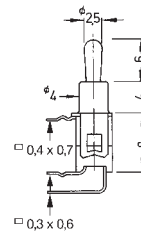
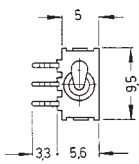
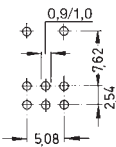

Special versions see page 24.

* Non-stock item; minimum quantity and delivery time on request.

Subminiature Toggle Switches waterproof



Specifications: see page 22

Models: Switching functions the closed contacts are opposite to the lever position;
Switching functions F/H: when looking at the brand name on the right hand side.

SPDT

ATE 1 D – VM	on	–	on
ATE 1 E – VM	on	off	on
ATE 1 F – VM*	mom	–	on
ATE 1 G – VM*	mom	off	mom
ATE 1 H – VM*	mom	off	on

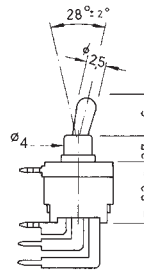
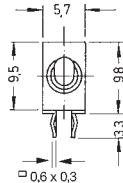
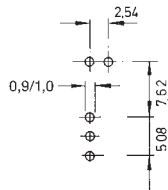

DPDT

ATE 2 D – VM	on	–	on
ATE 2 E – VM	on	off	on
ATE 2 F – VM*	mom	–	on
ATE 2 G – VM*	mom	off	mom
ATE 2 H – VM*	mom	off	on

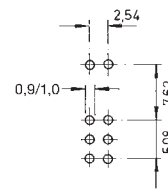

washable

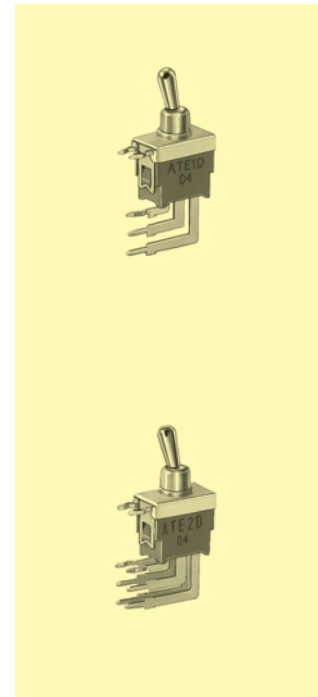

Accessories: see page 22.

Special versions*:

long flat lever

Additional to type number: F
Example of order: ATEF 2D – RA

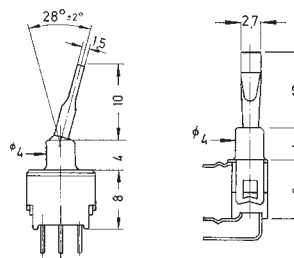

Spacing 5,08 mm

Additional to type number: – 1
Example of order: ATE 2E – RA-1

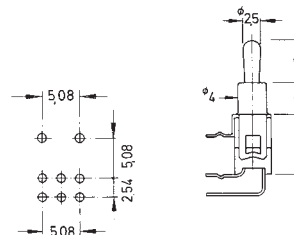

* Non-stock item; minimum quantity and delivery time on request

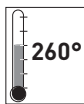

Subminiature Toggle Switches for SMT, waterproof

2

Specifications:

Contact rating:	max. 20 V AC/DC, 0,4 VA
Contact resistance:	< 20 mΩ
Insulation resistance:	> 1000 MΩ
Dielectric strength:	1000 V RMS at sea level
Operating temperature:	- 30 °C to + 85 °C
Electrical life:	50000 operations at full load
Contacts:	copper alloy, with gold plate over nickel plate
Terminals:	copper alloy, with tin plate over nickel plate
Protection:	IP 67
Material:	case and bushing: glass filled nylon 6/6 (UL 94 V-0) actuator: brass, chromium-plated switch support: brass, tin-plated
Mounting:	on pc-board – SMD

washable

Model: Switching function

SST 1 DT-R

on - on

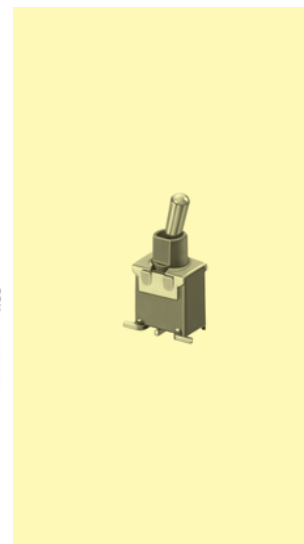
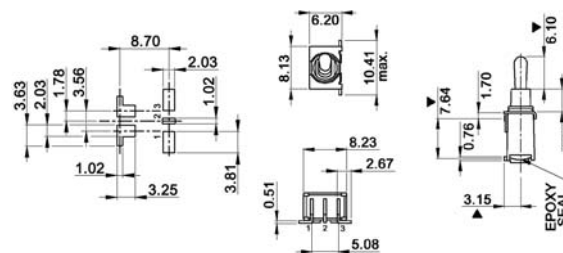

Packing: 500 pcs/reel

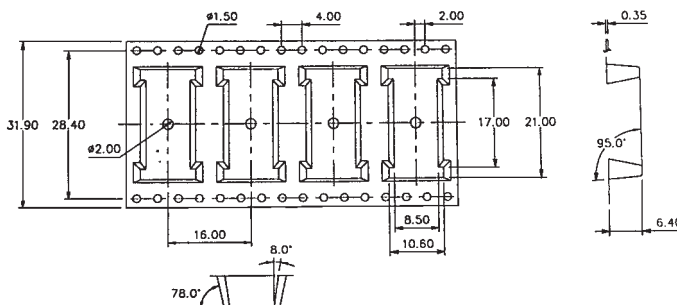

Subminiature Toggle Switches ESD proof, waterproof



Specifications:

Contact rating:	max. 20 V AC / DC, 0,4 VA
Contact resistance:	< 20 mΩ
Insulation resistance:	> 1000 MΩ
Dielectric strength:	1000 V, 50 Hz for the duration of 1 minute
Operating temperature:	- 30 °C to + 85 °C
Mechanical life:	minimum 50 000 operations
Contacts/Terminals:	copper alloy, gold-plated over nickel
Material:	case: nylon with glass fibre, meets UL 94 V-0, washable support: brass, tin-plated lever: brass, chromium-plated (...-ESD: PA, ESD resistance 6 kV)
Protection:	IP 67
Mounting:	on pc-board

Models: Switching functions: the closed contacts are opposite to the lever position.

washable

SPDT

TST 1 D (-ESD)	on	-	on
TST 1 E (-ESD)	on	off	on
TST 1 F (-ESD)	on	-	mom
TST 1 G (-ESD)	mom	off	mom
TST 1 H (-ESD)	on	off	mom

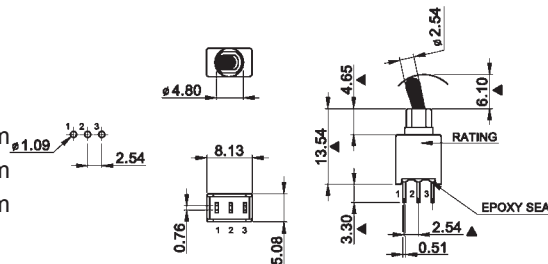

DPDT

TST 2 N (-ESD)	on	-	on
TST 2 R (-ESD)	on	-	mom
TST 2 P (-ESD)	on	off	on
TST 2 S (-ESD)	mom	off	mom
TST 2 T (-ESD)	on	off	mom
TST 2 PA (-ESD)	on	on	on
TST 2 SA (-ESD)	mom	on	mom
TST 2 TA (-ESD)	on	on	mom

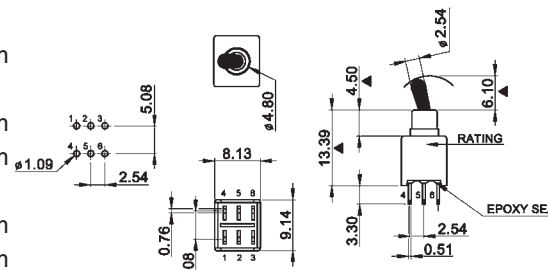



Subminiature Toggle Switches ESD proof, waterproof

Models: Switching functions: the closed contacts are opposite to the lever position.

washable

SPDT

- TST 1 D – RA (-ESD) on – on
- TST 1 E – RA (-ESD) on off on
- TST 1 F – RA (-ESD) on – mom
- TST 1 G – RA (-ESD) mom off mom
- TST 1 H – RA (-ESD) on off mom

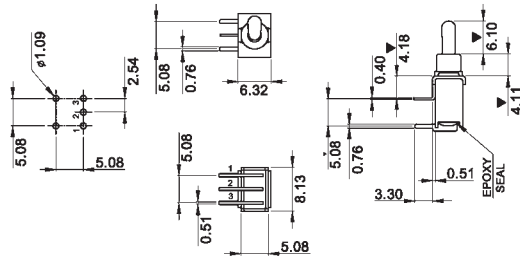

DPDT

- TST 2 N – RA (-ESD) on – on
- TST 2 R – RA (-ESD) on – mom
- TST 2 P – RA (-ESD) on off on
- TST 2 S – RA (-ESD) mom off mom
- TST 2 T – RA (-ESD) on off mom
- TST 2 PA – RA (-ESD) on on on
- TST 2 SA – RA (-ESD) mom on mom
- TST 2 TA – RA (-ESD) on on mom

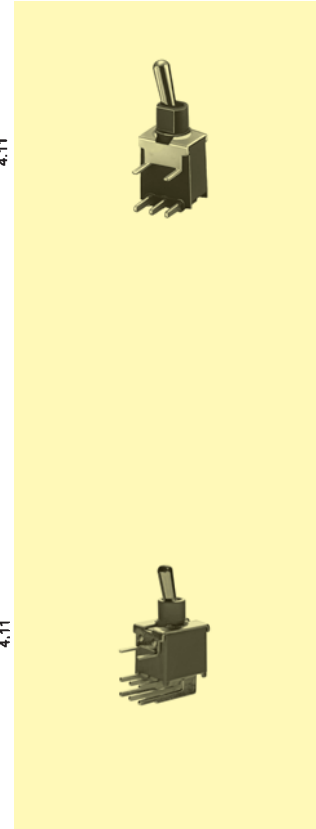
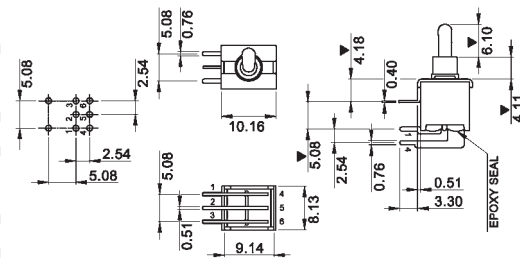

Microminiature Toggle Switches ESD proof



Specifications:

Contact rating:	max. 28 V DC, 0,4 VA min. 20 mV DC, 1 μ A
Contact resistance:	< 100 m Ω
Insulation resistance:	> 500 M Ω at 250 V DC
Dielectric strength:	250 V, 50 Hz for the duration of 1 minute
Operating temperature:	- 40 °C to + 85 °C
Mechanical life:	minimum 30 000 operations
Contacts:	phosphor bronze, gold-plated
Terminals:	PC terminals, crimped, phosphor bronze, gold-plated
Material:	case and lever: PES, meets UL 94 V-0, washable
Mounting:	on pc-board
Soldering conditions:	auto-soldering – max.: 7 sec, 250 °C \pm 5 °C – max.: 5 sec, 270 °C \pm 5 °C
ESD resistance:	> 8 kV (between lever and terminals)

Models :	Switching functions:	the closed contacts are opposite to the lever position;
	Switching functions F/H:	when looking at the brand name on the right hand side.

SPDT

FT 1 D – RA	on	–	on
FT 1 E – RA	on	off	on
FT 1 F – RA*	mom	–	on
FT 1 G – RA*	mom	off	mom
FT 1 H – RA*	mom	off	on

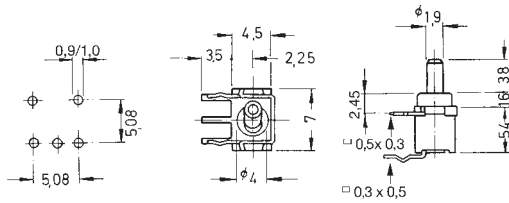

DPDT

FT 2 D – RA	on	–	on
FT 2 E – RA	on	off	on
FT 2 F – RA*	mom	–	on
FT 2 G – RA*	mom	off	mom
FT 2 H – RA*	mom	off	on

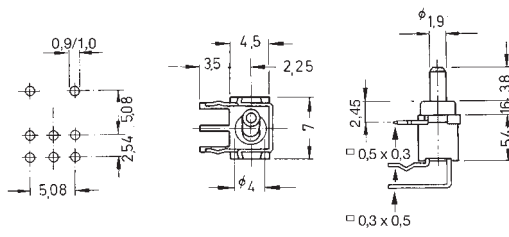

washable



* Non-stock item; minimum quantity and delivery time on request



Microminiature Toggle Switches ESD proof

Models: Switching functions: the closed contacts are opposite to the lever position;
 Switching functions F/H: when looking at the brand name on the left hand side.

washable

SPDT

FT 1 D	on	-	on
FT 1 E	on	off	on
FT 1 F	mom	-	on
FT 1 G	mom	off	mom
FT 1 H	mom	off	on

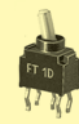
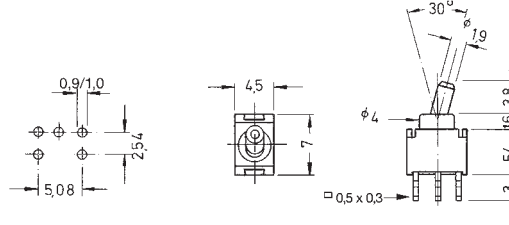

DPDT

FT 2 D	on	-	on
FT 2 E	on	off	on
FT 2 F	mom	-	on
FT 2 G	mom	off	mom
FT 2 H	mom	off	on

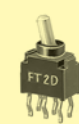
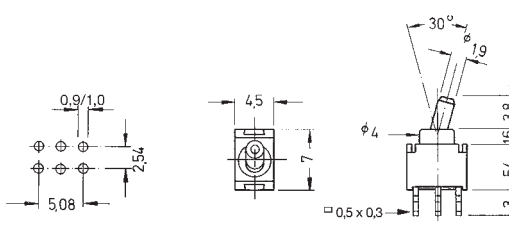

SPDT

FT 1 D-VM	on	-	on
FT 1 E-VM	on	off	on
FT 1 F-VM*	mom	-	on
FT 1 G-VM*	mom	off	mom
FT 1 H-VM*	mom	off	on

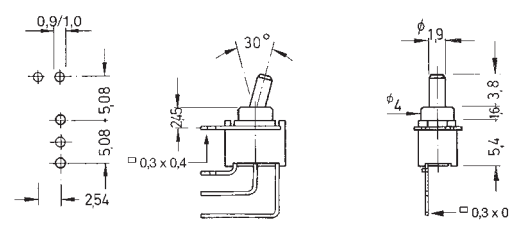

DPDT

FT 2 D-VM	on	-	on
FT 2 E-VM	on	off	on
FT 2 F-VM*	mom	-	on
FT 2 G-VM*	mom	off	mom
FT 2 H-VM*	mom	off	on

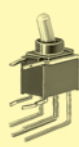
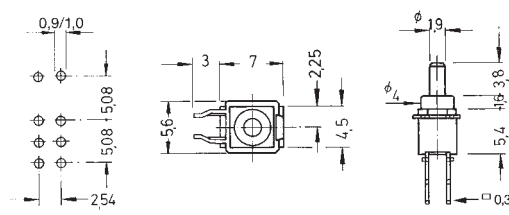

* Non-stock item; minimum quantity and delivery time on request

3

Pushbutton Switches

3.1 Miniature Pushbutton Switches



Series MPA		32–33
Series MPE	waterproof IP 67	34–35
Series MPG	heavy duty	36–37
Series MPS	snap action	38–39
Series MPME	ESD proof, IP 67	40
Series MSP	low cost to	41–43
Series MPBS / MPSA		44–45

3.2 Subminiature Pushbutton Switches



Series APE		46–47
Series MZP		48
Series SSP / TSP	SMD/low cost/IP 67	49

3.3 Microminiature Pushbutton Switches



Series FP	ESD proof	50–51
Series SSP		52

3.4 Illuminated Pushbutton Switches



Series DPW/DPWL	illuminated, IP 67	53–56
Series DPL	illuminated	57
Series MPLS	illuminated	58
Series TM	illuminated	59
Series LP	illuminated	60–62
Series TSSL	illuminated	63
Series TR / TM	illuminated	64–65
Series LTR / LTM	illuminated	66–67
Series TP	illuminated	68–69

3.5 Anti-Vandal Pushbutton Switches



Series MAV	illuminated, waterproof IP 67, IP 65	70–71
------------	---	-------

3.6 Tact Switches



Series TMP / TSE / TSSE	waterproof IP 67, IP 57	72–79
Series TMS / TMSE / TME		80–81
Series TSS / TS / TMSE	waterproof IP 67	82–95

3.7 Multi-function Switches



Series PLSJ		96
Series TSJ / TSSJ		97–100

Miniature Pushbutton Switches



Specifications:

Contact rating:	250 V AC, 3 A / 125 V AC, 6 A 30 V DC, 4 A / 12 V DC, 5 A 6 V DC, 6 A
Contact resistance:	< 10 mΩ
Insulation resistance:	> 1000 MΩ at 500 V DC
Dielectric strength:	1500 V, 50 Hz for the duration of 1 minute
Operating temperature:	- 45 °C to + 140 °C
Mechanical life:	minimum 30000 operations
Contacts:	coin silver (common contact copper alloy, silver-plated) also available gold-plated, version B and G (see page 4)
Terminals:	solder tags, copper alloy silver-plated further terminal versions see page 8
Material:	case: diallyl-phthalate meets UL 94 V-0, black metal parts: nickel-plated
Mounting:	bushing M 6 x 0,75 with locking plate, key 9 mm
Soldering conditions:	hand-soldering – max.: 60 W, 3 sec, 420 °C auto-soldering – max.: 5 sec, 270 °C

Accessories:

Buttons	Ø (height 8 mm)		Ø (height 10 mm)	
	orange	10 mm	KM 403	15 mm
blue	10 mm	KM 404	15 mm	KM 604
black	10 mm	KM 405	15 mm	KM 605
green	10 mm	KM 406	15 mm	KM 606
grey	10 mm	KM 407	15 mm	KM 607
yellow	10 mm	KM 408	15 mm	KM 608
red	10 mm	KM 409	15 mm	KM 609
white	10 mm	KM 410	15 mm	KM 610

Knurled nut, nickel-plated

M 6 x 0,75	8 mm	R 675
------------	------	-------

Covers

M 6 x 0,75	
Brass chromium-plated	CO 106
Brass black, matt finish	CO 106 S

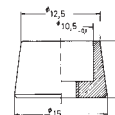



Miniature Pushbutton Switches

Models: Switching functions

S P D T

MPA 106 F
MPA 106 D

* on - mom
on - on

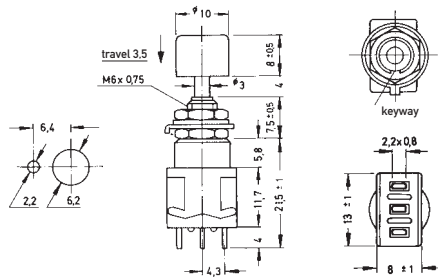

D P D T

MPA 206 R
MPA 206 N

* on - mom
on - on

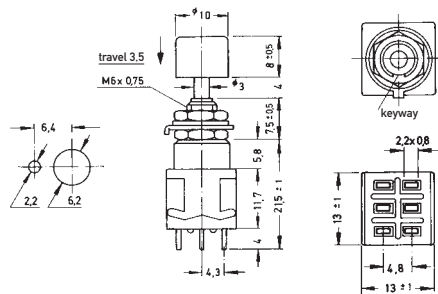

3 P D T

MPA 306 F
MPA 306 D

* on - mom
on - on

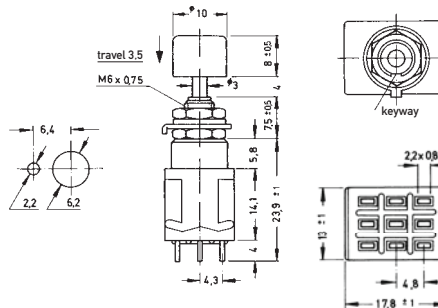

4 P D T

MPA 406 R
MPA 406 N

* on - mom
on - on

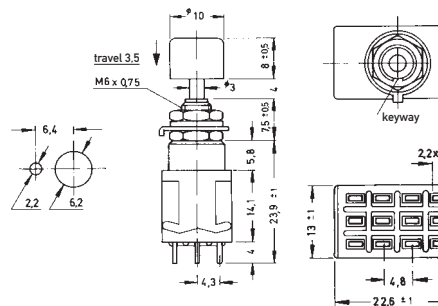

* When looking at the brand name the normally closed contact is on the right-hand side.

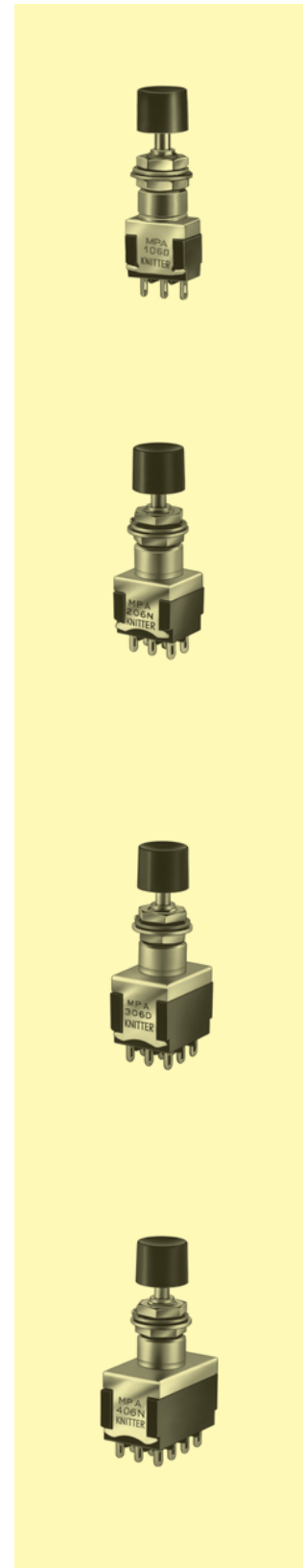



Specifications:

Contact rating:	250 V AC, 3 A / 125 V AC, 6 A 30 V DC, 4 A / 12 V DC, 5 A / 6 V DC, 6 A
Contact resistance:	< 10 mΩ
Insulation resistance:	> 1000 MΩ at 500 V DC
Dielectric strength:	1500 V, 50 Hz for the duration of 1 minute
Operating temperature:	- 45 °C to +140 °C
Mechanical life:	minimum 30 000 operations
Contacts:	coin silver (common contact copper alloy, silver-plated) also available gold-plated, version B and G (see page 4)
Terminals:	solder tags, copper alloy silver-plated further terminal versions see page 8
Case material:	diallyl-phthalate, black metal parts: nickel-plated
Protection:	30 minutes at 1 m water column; IP 67
Sealing:	neoprene O-rings between toggle/bushing and bushing/panel
Mounting:	bushing M 6 x 0,75, key 9 mm
Soldering conditions:	hand-soldering – max.: 60 W, 3 sec, 420 °C auto-soldering – max.: 5 sec, 270 °C

Accessories:

Buttons	∅ (height 8 mm)		∅ (height 10 mm)	
	orange	10 mm	KM 403	15 mm
blue	10 mm	KM 404	15 mm	KM 604
black	10 mm	KM 405	15 mm	KM 605
green	10 mm	KM 406	15 mm	KM 606
grey	10 mm	KM 407	15 mm	KM 607
yellow	10 mm	KM 408	15 mm	KM 608
red	10 mm	KM 409	15 mm	KM 609
white	10 mm	KM 410	15 mm	KM 610



Covers

M 6 x 0,75	
Brass, chromium-plated	CO 106
Brass, black, matt finish	CO 106 S

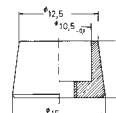



Miniature Pushbutton Switches waterproof

Models: Switching functions

S P D T

MPE 106 F
MPE 106 D

* on – mom
on – on

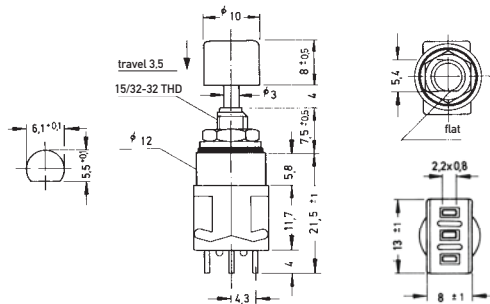

D P D T

MPE 206 R
MPE 206 N

* on – mom
on – on

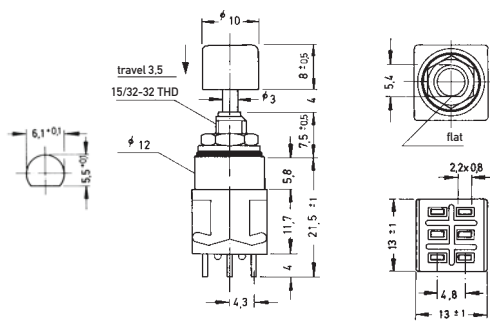

3 P D T

MPE 306 F
MPE 306 D

* on – mom
on – on

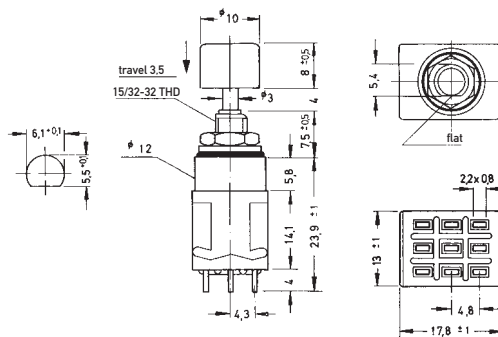

4 P D T

MPE 406 R
MPE 406 N

* on – mom
on – on

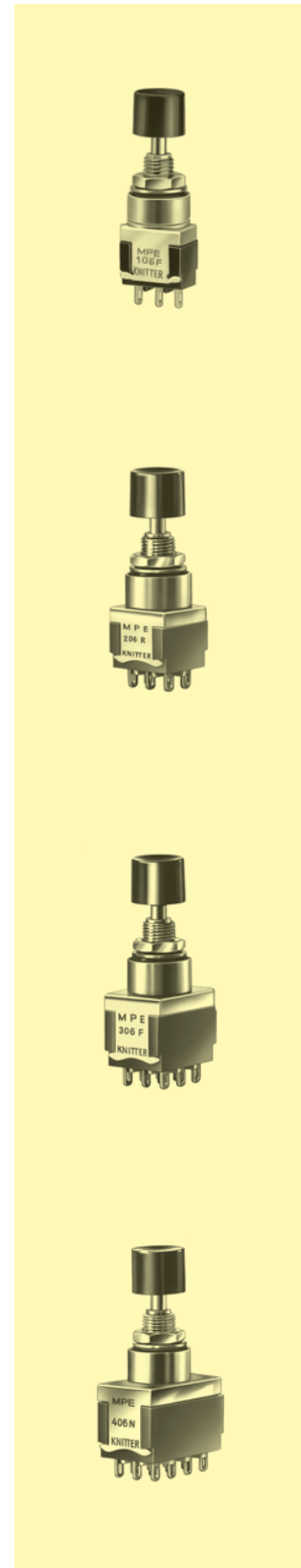
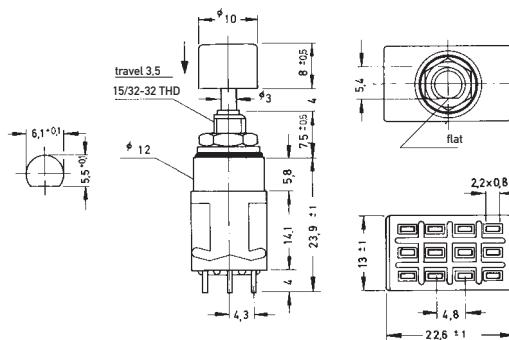

3

* When looking at the brand name the normally closed contact is on the right-hand side.



Specifications:

Contact rating:	250 V AC, 3 A / 125 V AC, 6 A 30 V DC, 4 A / 12 V DC, 5 A 6 V DC, 6 A
Contact resistance:	< 10 mΩ
Insulation resistance:	> 1000 MΩ at 500 V DC
Dielectric strength:	1500 V, 50 Hz for the duration of 1 minute
Operating temperature:	- 45 °C to +140 °C
Mechanical life:	minimum 30 000 operations
Contacts:	coin silver (common contact copper alloy, silver-plated) also available gold-plated, version B and G (see page 4)
Terminals:	solder tags, copper alloy silver-plated further terminal versions see page 8
Material:	case: diallyl-phthalate meets UL 94 V-0, black metal parts: nickel-plated
Mounting:	bushing 15/32-32 THD (M 12 x 0,75), key 14 mm
Soldering conditions:	hand-soldering – max.: 60 W, 3 sec, 420 °C auto-soldering – max.: 5 sec, 270 °C

Accessories:

Plastic caps (height 3,5 mm)	∅	
black	9 mm	CB 505
green	9 mm	CB 506
yellow	9 mm	CB 508
red	9 mm	CB 509



Waterproof sealing caps (height 14,8 mm)

grey	ET 207
red	ET 209

also available in fluoro silicone material





Miniature Pushbutton Switches heavy duty series

Models: Switching functions

S P D T

MPG 106 F
MPG 106 D

* on - mom
on - on

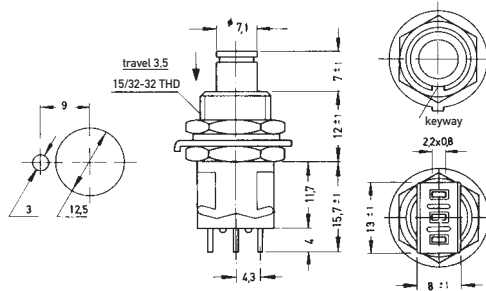

D P D T

MPG 206 R
MPG 206 N

* on - mom
on - on

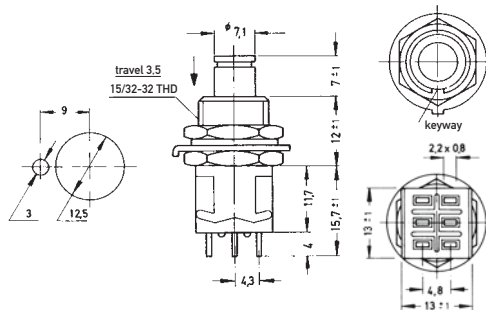

3 P D T

MPG 306 F
MPG 306 D

* on - mom
on - on

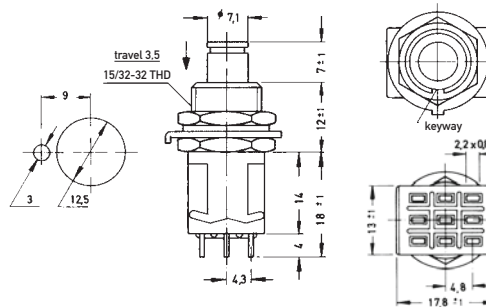

4 P D T

MPG 406 R
MPG 406 N

* on - mom
on - on

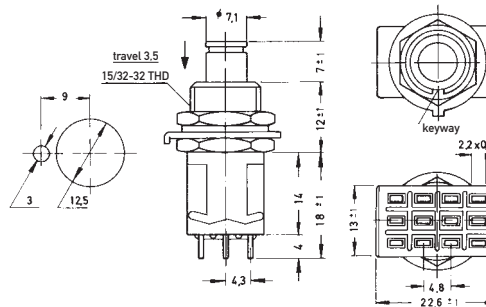

* When looking at the brand name the normally closed contact is on the right-hand side.

Miniature Pushbutton Switches snap action



Specifications:

Contact rating:	125 V AC, 3 A 30 V DC, 1 A / 12 V DC, 2 A / 6 V DC, 3 A
Contact resistance:	< 10 mΩ
Insulation resistance:	> 1000 MΩ at 500 V DC
Dielectric strength:	1000 V, 50 Hz for the duration of 1 minute
Operating temperature:	- 20 °C to + 80 °C
Mechanical life:	minimum 100 000 operations
Contacts:	coin silver (common contact copper alloy, silver-plated) also available gold-plated version B (see page 4)
Terminals:	solder tags, copper alloy silver-plated
Case material:	phenol resin, black
Mounting:	bushing M 6 x 0,75 with locking plate, key 9 mm
Soldering conditions:	hand-soldering – max.: 60 W, 3 sec, 420 °C

Accessories:

Buttons	∅ (height 8 mm)		∅ (height 10 mm)	
	orange	10 mm	KM 403	15 mm
blue	10 mm	KM 404	15 mm	KM 604
black	10 mm	KM 405	15 mm	KM 605
green	10 mm	KM 406	15 mm	KM 606
grey	10 mm	KM 407	15 mm	KM 607
yellow	10 mm	KM 408	15 mm	KM 608
red	10 mm	KM 409	15 mm	KM 609
white	10 mm	KM 410	15 mm	KM 610



Covers

M 6 x 0,75	
Brass, chromium-plated	CO 106
Brass, black, matt finish	CO 106 S

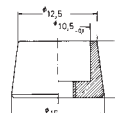



Miniature Pushbutton Switches snap action

Models: Switching functions

S P D T

MPS 103 F on – mom

measures: a = 1,5, b = 15^{±1}
travel 1,0

MPS 103 D on – on

measures: a = 2,5, b = 16^{±1}
travel 2,5

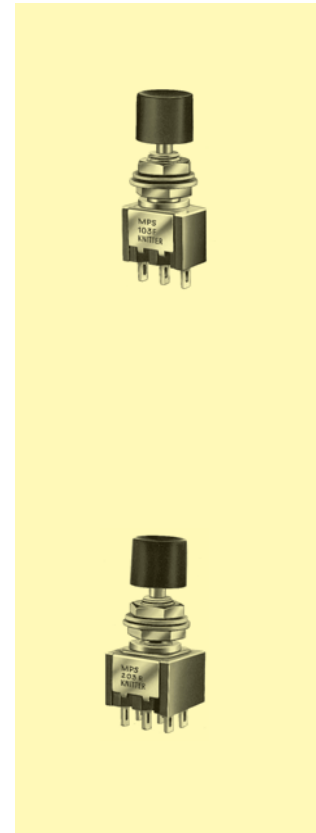
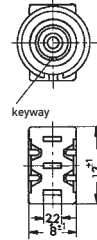
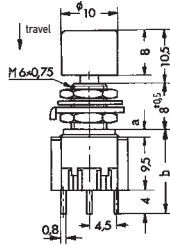

D P D T

MPS 203 R on – mom

measures: a = 1,5, b = 15^{±1}
travel 1,0

MPS 203 N on – on

measures: a = 2,5, b = 16^{±1}
travel 2,5

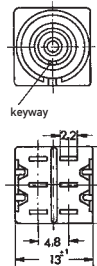
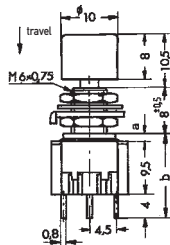

Circuit diagram:

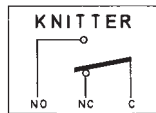

Miniature Pushbutton Switches ESD proof, waterproof



Specifications:

Contact rating:	20 V AC, 0,4 VA
Contact resistance:	< 20 mΩ
Insulation resistance:	> 1000 MΩ
Dielectric strength:	1000 V, 50 Hz for the duration of 1 minute
Operating temperature:	- 30 °C to + 85 °C
Mechanical life:	minimum 50 000 operations
Contacts:	gold-plated over nickel barrier
Terminals:	solder tags or PC terminals
Material:	case: PA / PES meets UL 94 V-0, washable button: PA meets UL 94 V-0, washable
Protection:	IP 67
Mounting:	bushing \varnothing 6,35 mm with locking plate or on pc-board
Soldering conditions:	hand-soldering – max.: 5 sec, 350 °C auto-soldering – max.: 10 sec, 260 °C
ESD resistance:	> 10 kV (between button and terminals)

Models: Switching functions

S P D T

MPME 1FB-ESD on – mom

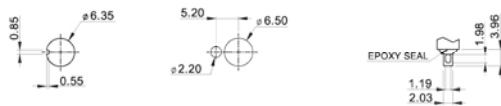
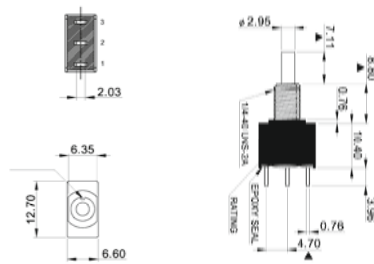

S P D T

MPME 1FB-PC ESD on – mom

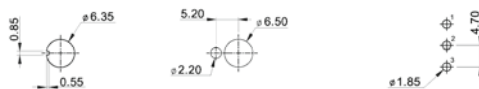
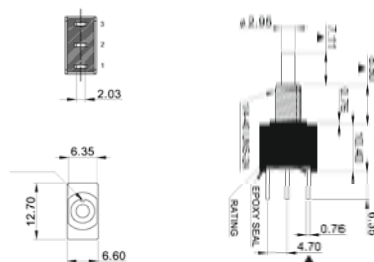

washable





Miniature Pushbutton Switches

Specifications:

Contact rating:	250 V AC, 1 A / 125 V AC, 3 A 24 V DC, 2 A
Contact resistance:	< 30 mΩ
Insulation resistance:	> 500 MΩ at 500 V DC
Dielectric strength:	1000 V, 50 Hz for the duration of 1 minute
Operating temperature:	- 45 °C to + 110 °C
Mechanical life:	minimum 30 000 operations
Contacts:	coin silver, also available gold-plated, version G (see page 4)
Terminals:	solder tags
Material:	phenolformaldehyde MSP 103 B black, MSP 103 C brown
Mounting:	bushing M 6 x 0,75
Soldering conditions:	hand-soldering – max.: 20 W, 3 sec, 350 °C

3

Models:

Switching functions

S P D T

MSP 103 B
MSP 103 C

on – (mom)
off – mom

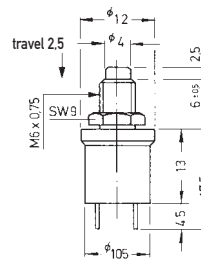
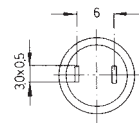

Button colour: orange

S P D T

MSP 103 BK
MSP 103 CK

on – (mom)
off – mom

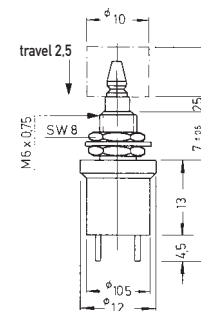
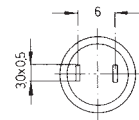

Buttons see page 34.

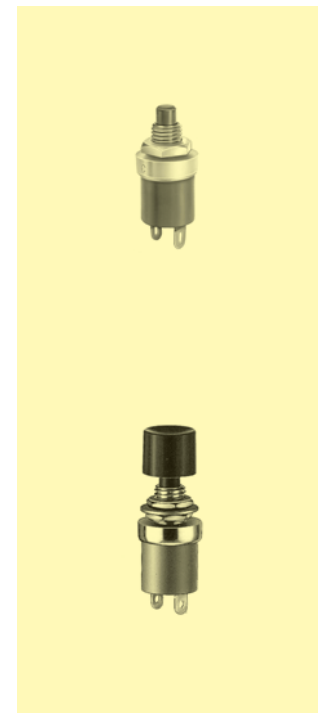

Miniature Pushbutton Switches

Specifications:

Contact rating:	250 V AC, 0,5 A / 120 V AC, 1 A 28 V DC, 1 A
Contact resistance:	< 30 mΩ
Insulation resistance:	> 100 MΩ at 500 V DC
Dielectric strength:	500 V, 50 Hz for the duration of 1 minute
Operating temperature:	- 20 °C to + 70 °C
Mechanical life:	more than 10 000 operations
Contacts:	phosphor bronze, silver-plated
Terminals:	PC terminals, brass silver-plated
Material:	case: copper alloy, nickel-plated / POM button: PA 66
Mounting:	single-hole mounting, Ø 6.35 mm or on pc-board
Soldering conditions:	auto-soldering – 5 sec ± 0,5 sec, 260 °C

Models: Switching functions

SPST
MSP 101 A on – off

SPST
MSP 101 A – RA on – off

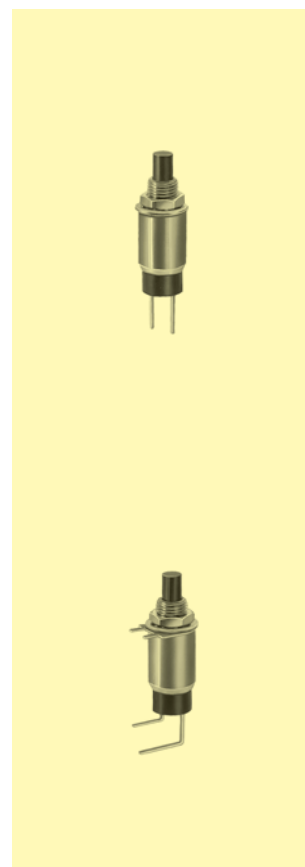
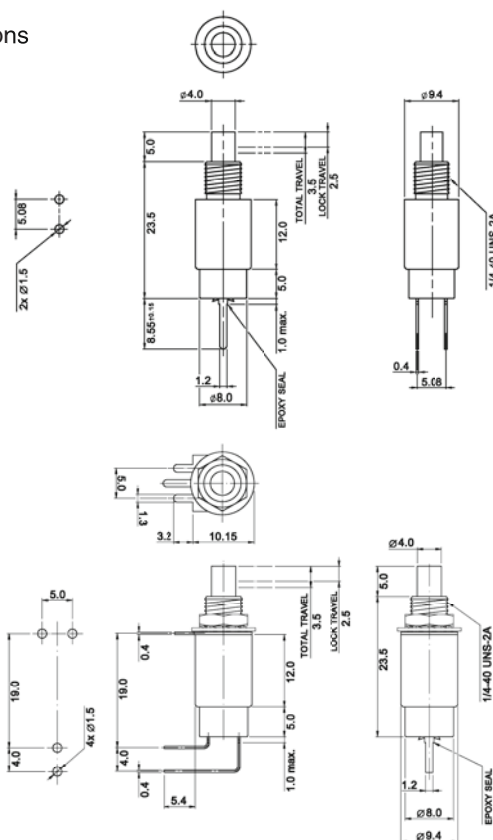



Miniature Pushbutton Switches

Specifications:

Contact rating:	30 V DC, 650 mA
Contact resistance:	< 20 mΩ
Insulation resistance:	> 500 MΩ at 500 V DC
Dielectric strength:	500 V, 50 Hz for the duration of 1 minute
Operating temperature:	- 20 °C to + 60 °C
Mechanical life:	minimum 20 000 operations
Contacts:	brass, silver-plated
Terminals:	solder tags
Material:	phenolformaldehyde, black
Mounting:	single-hole
Soldering conditions:	hand-soldering – max.: 3 sec, 260 °C ± 5 °C

3

Models:

Contact arrangement

MSP 101 C
button colour: red

normally open

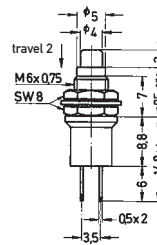
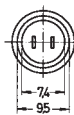

MSP 121 B
button colour: black
red

normally closed

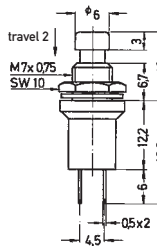
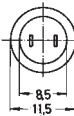

MSP 121 C
button colour: black
red

normally open

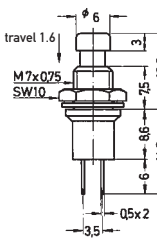
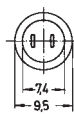

MSP 131 C
button colour: black

normally open

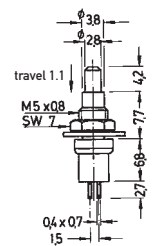
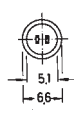

Miniature Pushbutton Switches

Specifications:

Contact rating:	100 V AC, 0.5 A / 25 V DC, 1 A
Contact resistance:	< 10 mΩ
Insulation resistance:	> 100 MΩ
Dielectric strength:	500 V, 50 Hz for the duration of 1 minute
Operating temperature:	-10 °C to +60 °C
Mechanical life:	minimum 30 000 operations
Contacts:	phosphor-bronze, silver-plated
Terminals:	brass, silver-plated
Case:	base: ABS, cover: ABS, actuator: POM
Mounting:	on pc-board
Timing:	non-shorting
Travel:	switch-travel: 3.2 mm, total travel: 4.7 mm
Soldering conditions:	auto-soldering – max. 5 sec, 260 °C ± 5 °C

Series MPBS

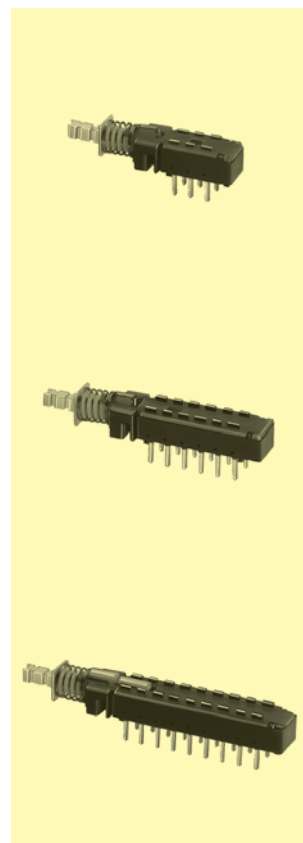
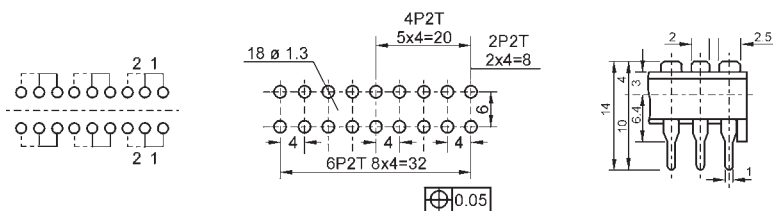
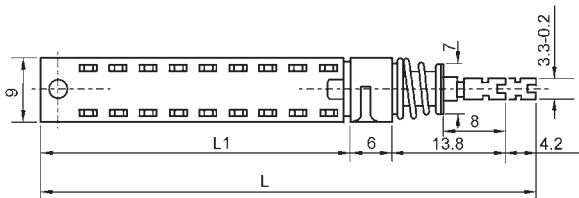
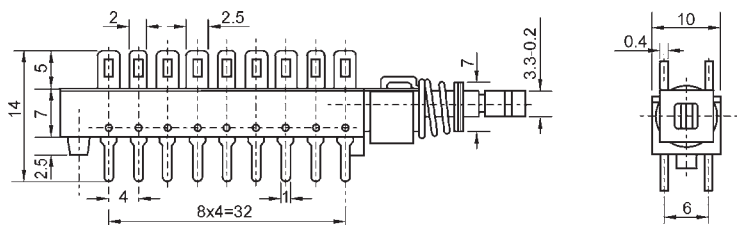

Ordering code:

MPBS - - 14

Number of poles:

- 22H01 2 poles
- 42H01 4 poles
- 62H01 6 poles

Switching mode:

- mom – on
- on – on

Operating force:

- F 3.0 N ±1.0 N
- F0 1.5 N ±0.5 N
2.0 N ±0.5 N (for 62H01)

Type	L (mm)	L1 (mm)
MPBS-22H01...	42	18
MPBS-42H01...	54	30
MPBS-62H01...	66	42



Miniature Pushbutton Switches

Specifications:

Contact rating:	30 V DC, 100 mA
Contact resistance:	< 20 mΩ
Insulation resistance:	> 100 MΩ
Dielectric strength:	500 V, 50 Hz for the duration of 1 minute
Operating temperature:	-10 °C to +60 °C
Electrical life:	minimum 10 000 operations
Contacts:	beryllium-copper, silver-plated
Terminals:	brass, silver-plated
Case:	base: PBT, cover: POM, actuator: POM
Mounting:	on pc-board
Timing:	non-shorting
Soldering conditions:	auto-soldering – max. 5 sec, 260 °C ± 5 °C

Models:

MPSA-22E08L-0
MPSA-22E08-0

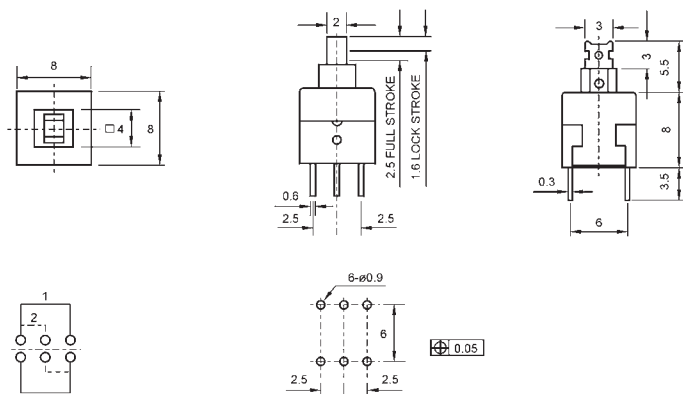

MPSA-42E06L-0
MPSA-42E06-0

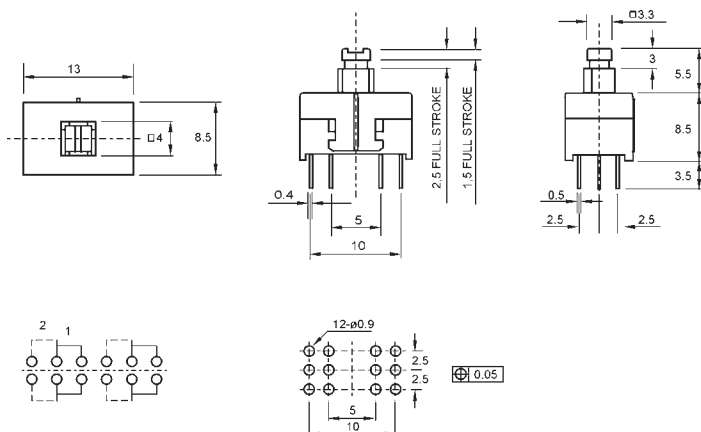

Minimum order quantity 1.000 pcs

Ordering code:

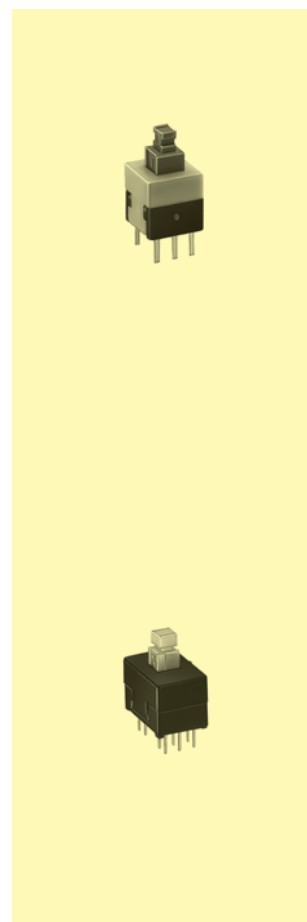
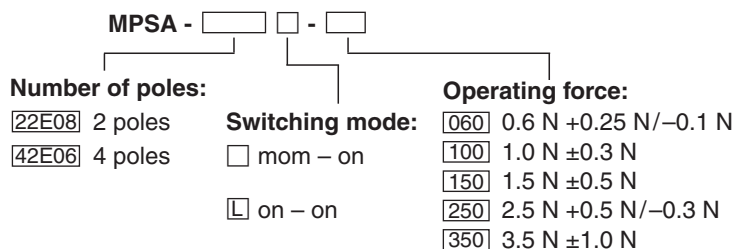

Subminiature Pushbutton Switches



Specifications:

Contact rating:	max. 48 V AC/DC, 0,4 VA / max. 50 mA min. 20 mV AC/DC, 1 μ A
Contact resistance:	< 50 m Ω
Insulation resistance:	> 500 M Ω at 250 V DC
Dielectric strength:	500 V, 50 Hz for the duration of 1 minute
Operating temperature:	- 20 °C to + 80 °C
Mechanical life:	minimum 60 000 operations
Contacts:	phosphor bronze, gold-plated over nickel barrier
Terminals:	APE – PC terminals, crimped, phosphor bronze, gold-plated over nickel barrier
Material:	case: PBT, meets UL 94 V-0, washable metal parts: brass, nickel-plated
Mounting:	on pc-board
Soldering conditions:	auto-soldering – max.: 5 sec, 260 °C \pm 5 °C

The stability can be improved by using a supporting bracket.

Accessories:

Plastic caps

black	KA 3105
green	KA 3106
grey	KA 3107
yellow	KA 3108
red	KA 3109
white	KA 3110

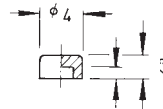

Supporting bracket for
Order number

APE 1 F
AZ 0001

APE 2 F
AZ 0005

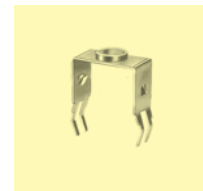
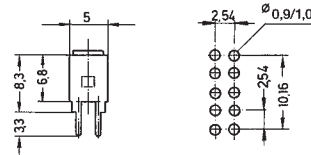
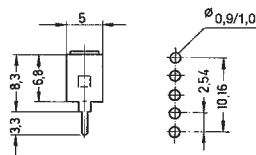



Subminiature Pushbutton Switches

Models: Switching functions: when looking at the brand name,
the normally closed contact is on the right-hand side

SPDT

APE 1 F

on - mom



DPDT

APE 2 F

on - mom

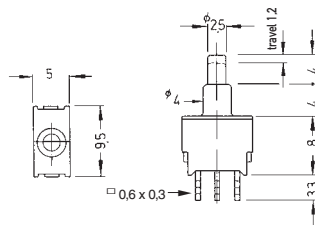
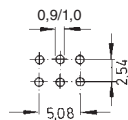

washable

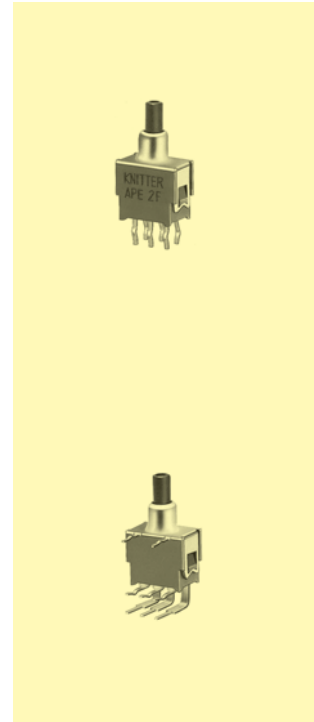

SPDT

APE 1 F - RA

on - mom

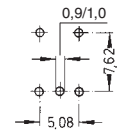

DPDT

APE 2 F - RA

on - mom

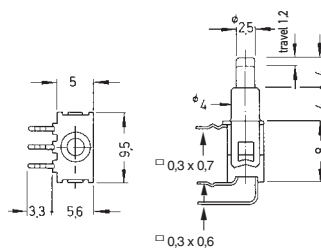
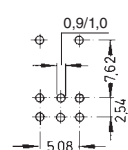

Special pin configuration:

Subminiature pushbutton switch
with 5,08 mm spacing

Additional to type number: - 1

Example of order: APE 2 F - RA - 1

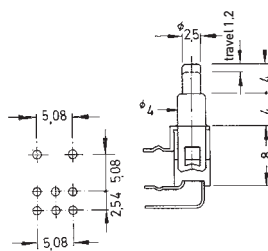

Subminiature Pushbutton Switches



Specifications:

Contact rating:	250 V AC, 1 A / 120 V AC, 3 A / 28 V DC, 3 A
Contact resistance:	< 50 mΩ
Insulation resistance:	> 1000 MΩ
Dielectric strength:	1000 V, 50 Hz for the duration of 1 minute
Operating temperature:	- 30 °C to + 85 °C
Mechanical life:	minimum 50 000 operations
Contacts:	brass, silver-plated
Terminals:	brass, silver-plated
Case:	base: PA, cover: stainless steel, actuator: PA
Mounting:	single-hole
Timing:	non-shorting
Soldering conditions:	auto-soldering – max. 10 sec, max. 260 °C (pre-heat max. 120 s, max 150 °C) manual soldering – max. 5 sec, max 350 °C

Models: Switching functions

MZP 1 D on – on

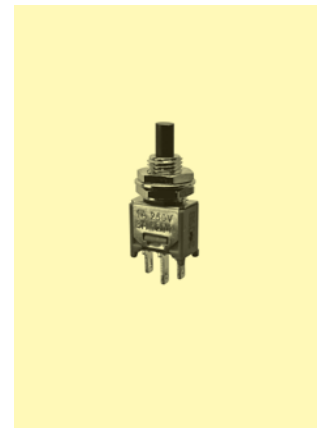
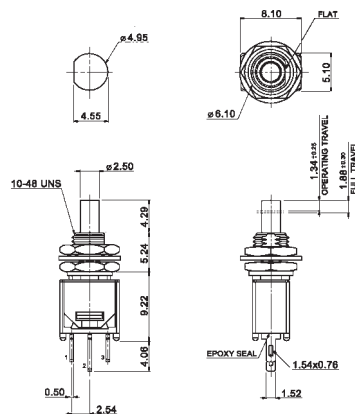

Packing: 100 pcs/bag

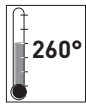

Subminiature Pushbutton Switches waterproof

Specifications:

Contact rating:	20 V AC/DC, 0.4 VA
Contact resistance:	< 20 mΩ
Insulation resistance:	> 1000 MΩ
Dielectric strength:	1000 V, 50 Hz for the duration of 1 minute
Operating temperature:	- 30 °C to + 85 °C
Mechanical life:	minimum 50 000 operations
Contacts:	copper-alloy, gold-plate over nickel plate
Terminals:	copper-alloy, TSP: gold-plate over nickel plate, SSP: tin-plate over nickel-plate
Case:	PA, support: brass, tin-plated, actuator: PA
Protection:	IP 67
Mounting:	TSP: on pc-board, holes Ø 1.09 mm, SSP: SMD
Travel:	0.9 mm
Soldering conditions:	TSP: auto-soldering – max. 10 sec, max. 260 °C (pre-heat max. 120 sec, max. 150 °C), SSP: see reflow-profile manual soldering – max. 5 sec, max 350 °C

3

Models: Switching functions

washable

TSP 1 C	off – mom				
TSP 1 C – RA	off – mom				
SSP 1 CT-R	off – mom				
Packing:					

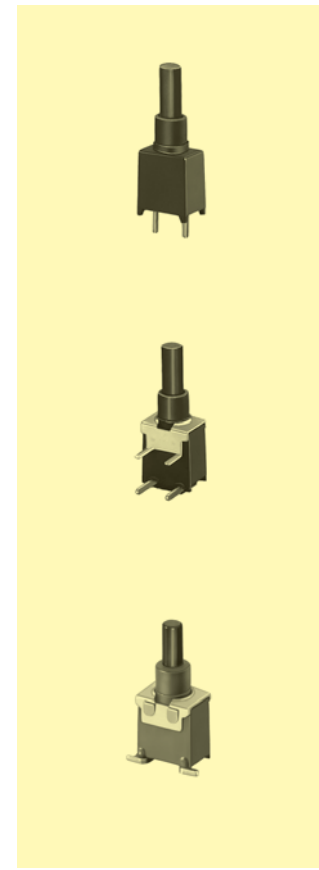

Microminiature Pushbutton Switches ESD proof



Specifications:

Contact rating:	max. 28 V DC, 0,4 VA min. 20 mV DC, 1 μ A
Contact resistance:	< 100 m Ω
Insulation resistance:	> 500 M Ω at 250 V DC
Dielectric strength:	250 V, 50 Hz for the duration of 1 minute
Operating temperature:	- 40 °C to + 85 °C
Mechanical life:	minimum 30 000 operations
Contacts:	phosphor bronze, gold-plated
Terminals:	PC terminals, crimped, phosphor bronze gold-plated
Material:	case and button: PES, meets UL 94 V-0, washable
Mounting:	on pc-board
Soldering conditions:	auto-soldering – max.: 7 sec, 250 °C \pm 5 °C max.: 5 sec, 270 °C \pm 5 °C
ESD resistance:	> 8 kV (between button and terminals)

Accessories:

Plastic caps

black	KF 4105
grey	KF 4107
red	KF 4109
white	KF 4110

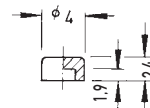

Models:

Switching functions: when looking at the brand name, the normally closed contact is on the right hand side.

washable

S P D T
FP 1 F – RA

mom – on

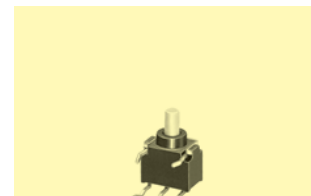
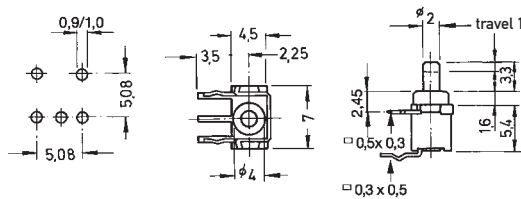

D P D T
FP 2 F – RA

mom – on

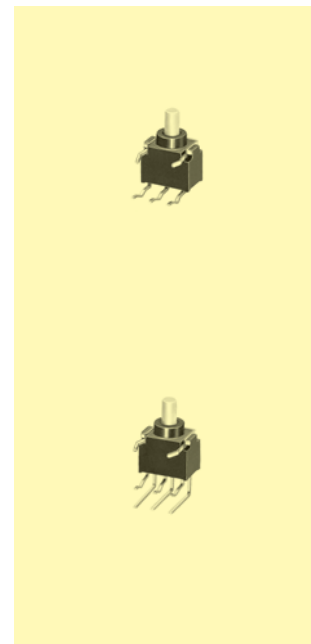
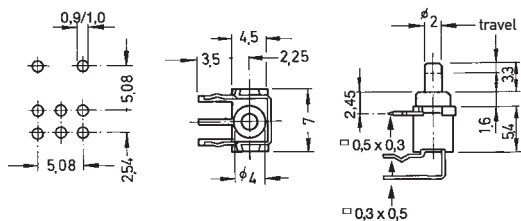



Microminiature Pushbutton Switches ESD proof

Models: Switching functions: when looking at the brand name, the normally closed contact is on the left hand side.

washable

SPDT
FP 1F

on - mom

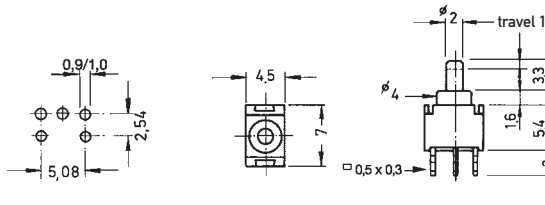

DPDT
FP 2F

on - mom

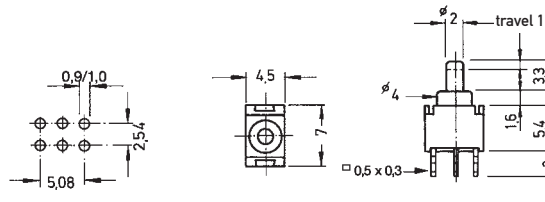

SPDT
FP 1F-VM

on - mom

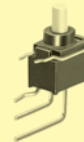
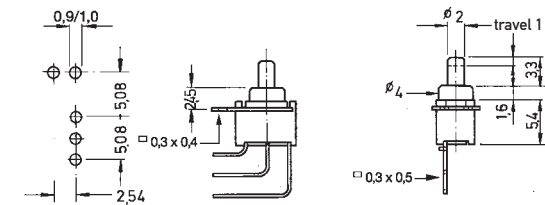

DPDT
FP 2F-VM

on - mom

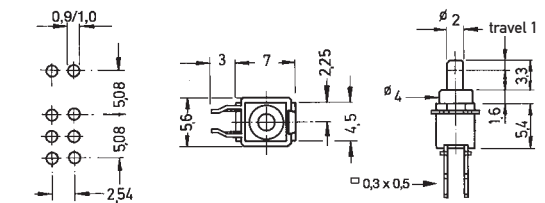

3

Microminiature Pushbutton Switches for SMT

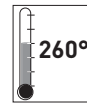

Specifications:

Contact rating:	50 V DC, 10 mA
Contact resistance:	< 100 mΩ
Insulation resistance:	>1000 MΩ
Dielectric strength:	100V, 50 Hz for the duration of 1 minute
Operating temperature:	-10 °C to +60 °C
Operating force:	1.1 ± 0.8 N
Mechanical life:	minimum 100 000 operations
Material:	Contacts, Terminals: phosphor-bronze, gold-plated Stem: brass, nickel-plated Case: HTN, black Cover: stainless steel
Travel:	0.65 ± 0.45 mm

Models: Switching function

SSP 129 T

off – mom

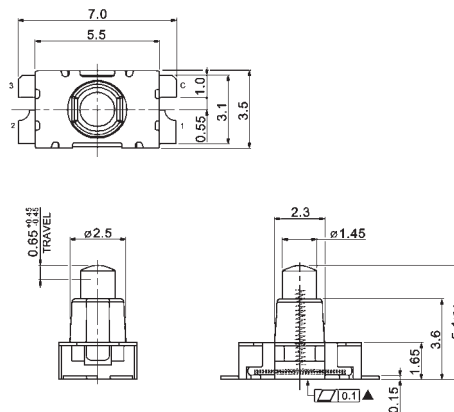

PCB Layout

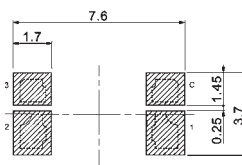

Circuit diagram

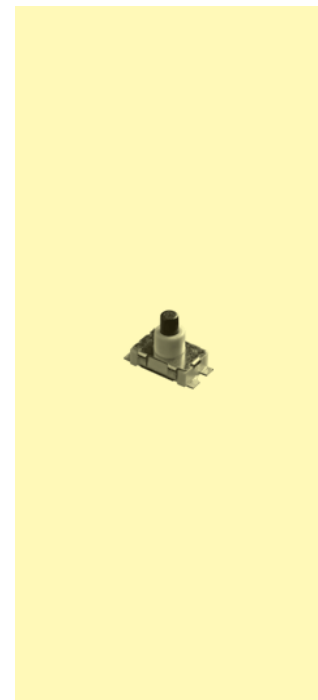
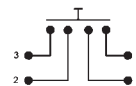

Packing:
1000 pcs/reel

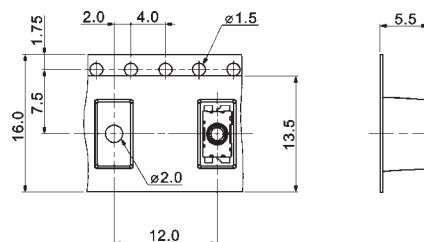



Illuminated Pushbutton Switches waterproof

Specifications:

Contact rating:	momentary: 125 V AC, 125 mA	32 V AC, 400 mA	50 V DC, 100 mA
	latching: 125 V AC, 2 A	24 V DC, 100 mA	
Contact resistance:	<50 mΩ		
Insulation resistance:	>1000 MΩ		
Dielectric strength:	1000V, 50 Hz for the duration of 1 minute		
Operating temperature:	-30 °C to +85 °C		
Operating force:	3.5 N ± 1.5 N		
Mechanical life:	minimum 1 000 000 operations		
Material:	Surface of contacts, terminals: gold over silver plated		
	Base: DAP, UL 94 V-0		
	Case, Cap: PA 66		
Ingress Protection:	IP 67		
Mounting:	snap-in or bushing M12x0.75, key 14 mm		
Soldering conditions:	hand soldering, max. 5 s, 350 °C		
Travel:	momentary: 1.5 mm, latching: 2.5 mm		

Models:

Switching functions

DPW 1 AG-K

on – off

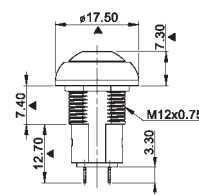
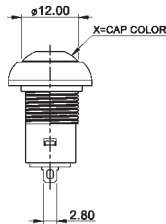

DPW 1 BG S-K

on – (mom)

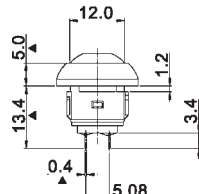
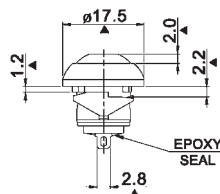

DPW 1 CG-B

off – mom

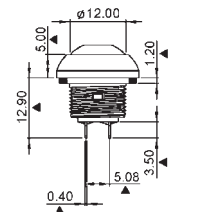
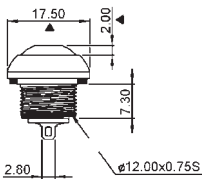

Ordering Code:

DPW 1 G -

Switching function:

- A on – off
- B on – (mom)
- C off – mom

Bushing:

- Thread
- S Snap-in (not for switching function A)

Actuator:

- W white
- K black
- R red
- O orange
- Y yellow
- G green
- B blue

Terminals:

- Solder tags
- FO Fast-on

Illuminated Pushbutton Switches waterproof



Specifications:

Contact rating:	125 V AC, 125 mA / 50 V DC, 100 mA / 32 V AC, 400 mA
Contact resistance:	< 50 mΩ
Insulation resistance:	> 1000 MΩ at 500 V DC
Dielectric strength:	1000 V, 50 Hz for the duration of 1 minute
Operating temperature:	-30 °C to +85 °C
Mechanical life:	minimum 1 000 000 operations
Contacts:	gold-plated over silver
Terminals:	gold-plated
Travel:	1,5 mm
Material:	case: thermoplastic meets UL 94 V-0; button: PA
Protection:	IP 67
Soldering conditions:	hand-soldering – max.: 3 sec, 300 °C

Models:

Switching functions

DPWL 1 AG KG on – off

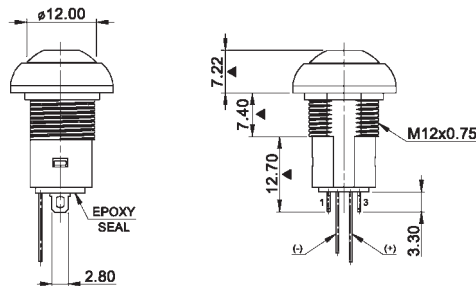

DPWL 1 CG S-KY off – mom

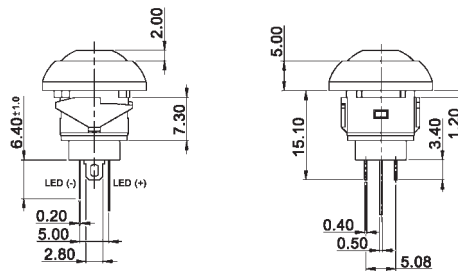

Ordering Code:

DPWL 1 G -

Switching function:

- A F – F₀
- B F – T₀
- C F₀ – T

Bushing:

- Thread
- S Snap-in (not for switching function A)

Actuator:

- W white
- K black
- R red
- O orange
- Y yellow
- G green
- B blue

LEDs:

- W white
- R red
- Y yellow
- G green
- B blue
- YG yellow/green
- YB yellow/blue
- YR yellow/red
- RG red/green
- RB red/blue
- GB green/blue

Terminals:

- Solder tags
- FO Fast-on



Illuminated Pushbutton Switches waterproof

Specifications:

Contact rating:	250 V AC, 200 mA	48 V AC, 500 mA	50 V DC, 200 mA
Contact resistance:	<50 mΩ		
Insulation resistance:	> 1000 MΩ		
Dielectric strength:	1000 V, 50 Hz for the duration of 1 minute		
Operating temperature:	-30 °C to +85 °C		
Operating force:	3.5 N ± 1.5 N		
Mechanical life:	minimum 1 000 000 operations		
Material:	Surface of contacts, terminals: gold over silver plated		
	Base: DAP, UL 94 V-0		
	Case: Zinc alloy		
	Cap: PA 66		
Ingress Protection:	IP 67		
Mounting:	bushing M12x0.75, key 14 mm		
Soldering conditions:	hand soldering, max. 5 s, 350 °C		
Travel:	1.5 mm		

3

Models: Switching functions

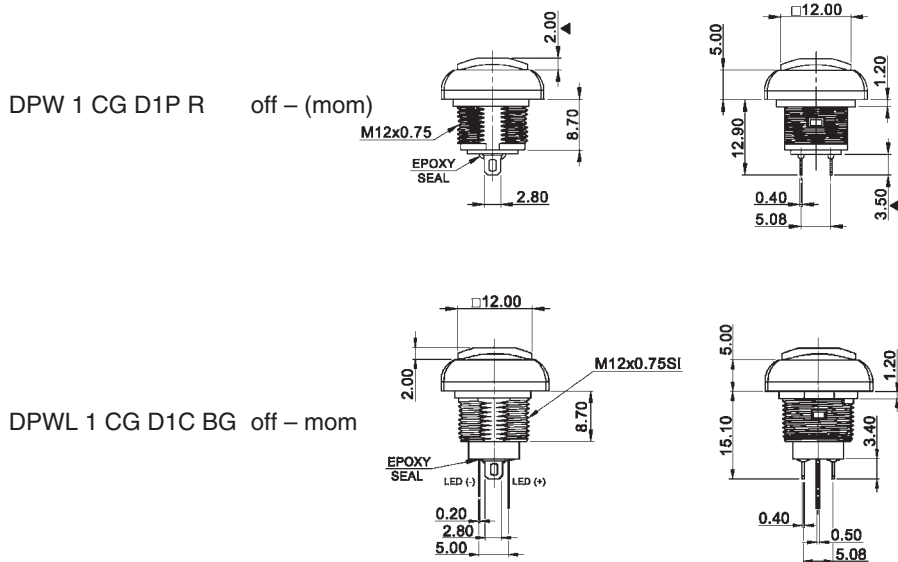

Ordering Code:

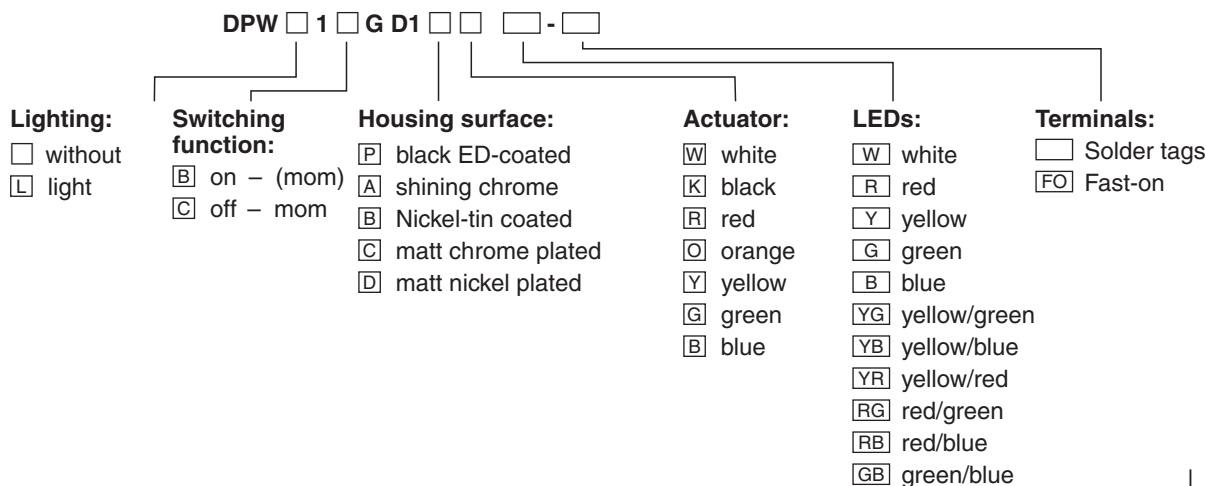

Illuminated Pushbutton Switches waterproof



Specifications:

Contact rating:	250 V AC, 200 mA 48 V AC, 500 mA 50 V DC, 200 mA
Contact resistance:	< 50 mΩ
Insulation resistance:	> 1000 MΩ
Dielectric strength:	1000 V, 50 Hz for the duration of 1 minute
Operating temperature:	-30 °C to +85 °C
Operating force:	3.5 N ± 1.5 N
Mechanical life:	minimum 1 000 000 operations
Material:	Surface of contacts, terminals: gold over silver plated Base: DAP, UL 94 V-0 Case: Zinc alloy Cap: PA 66
Ingress Protection:	IP 67
Mounting:	bushing M12x0.75, key 14 mm
Soldering conditions:	hand soldering, max. 5 s, 350 °C
Travel:	1.5 mm

Models:

Switching functions

DPW 1 CG D2P R

off – (mom)

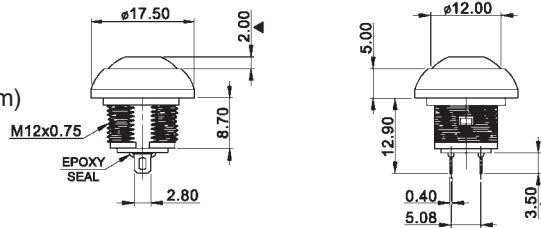

DPWL 1 CG D2C KG off – mom

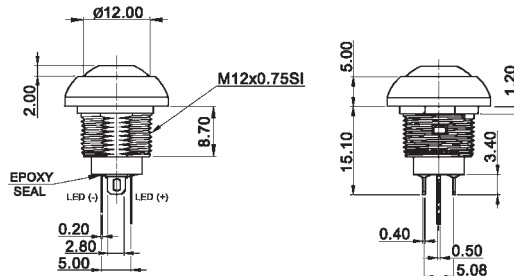

Ordering Code:

DPW 1 G D2 -

Lighting:

- without
- light

Switching function:

- on – (mom)
- off – mom

Housing surface:

- P black ED-coated
- A shining chrome
- B Nickel-tin coated
- C matt chrome plated
- D matt nickel plated

Actuator:

- W white
- K black
- R red
- O orange
- Y yellow
- G green
- B blue

LEDs:

- W white
- R red
- Y yellow
- G green
- B blue
- YG yellow/green
- YB yellow/blue
- YR yellow/red
- RG red/green
- RB red/blue
- GB green/blue

Terminals:

- Solder tags
- FO Fast-on



Illuminated Pushbutton Switches waterproof

Specifications:

Contact rating:	30 V DC, 100 mA
Contact resistance:	<50 mΩ
Insulation resistance:	> 100 MΩ
Dielectric strength:	500 V, 50 Hz for the duration of 1 minute
Operating temperature:	-40 °C to +85 °C
Operating force:	2.5 N ± 1 N
Mechanical life:	minimum 50 000 operations
Material:	Surface of contacts, terminals: gold over nickel plated Case: PA 66 Cap: PC
Mounting:	snap-in, mounting-hole diameter 8 mm, panel thickness 0.8...1.2 mm
Soldering conditions:	hand soldering, max. 3 s, 300 °C
Travel:	1.2 mm

3

Models:

Switching function

DPL 1 CB x

off – mom

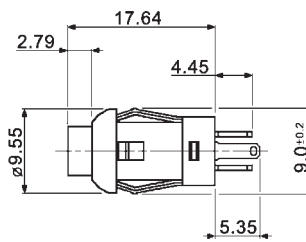
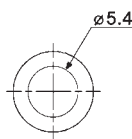

Ordering Code:

DPL 1 CB

LEDs:

- W white
- R red
- Y yellow
- G green
- B blue
- BG blue/green

Illuminated Pushbutton Switches for SMT

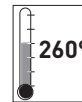

Specifications:

Contact rating:	50 V DC, 250 mA; max. 3,5 VA
Contact resistance:	<50 mΩ at 2–4 V DC, 100 mA
Insulation resistance:	> 1000 MΩ
Dielectric strength:	250 V AC (50–60 Hz) for 1 minute
Operating temperature:	–30 °C to +85 °C
Mechanical life:	minimum 30 000 operations
Material:	case and actuator: glass filled LCP, UL 94 V–0, grey Housing: stainless steel Contact and terminal: copper alloy, silver plated with gold flash
Operating force:	250 ± 100 gf
Mounting:	on pc-board – SMD

Models: Switching functions

SPDT

MPLS 12 F □ on – mom

MPLS 12 D □ on – on

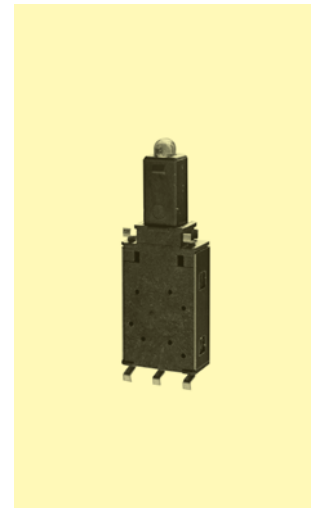
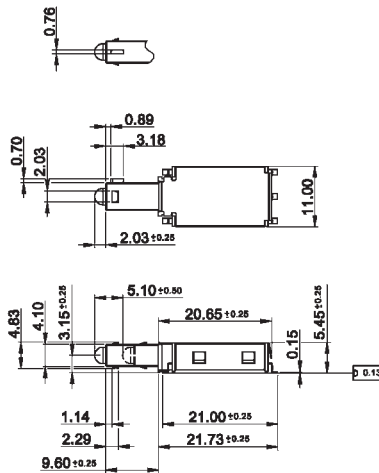

P.C.B. Layout



Circuit diagram

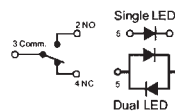

MPLS 12 F □

MPLS 12 D □

LED colour:

- W white
- Y yellow
- R red
- G green
- AG amber/green
- RG red/green

Packing: 450 pcs/reel



Illuminated Pushbutton Switches

Specifications:

Contact rating:	32 V DC, 100 mA, 1 VA
Contact resistance:	< 150 mΩ
Insulation resistance:	> 100 MΩ
Dielectric strength:	250 V, 50 Hz for the duration of 1 minute
Operating temperature:	-40 °C to +85 °C
Operating force:	4 N ± 1.2 N
Mechanical life:	minimum 25 000 operations
Material:	Contacts: stainless steel, silver plated Terminals: brass, gold plated Case: LCP, UL 94 V-0 Actuator: PC
Mounting:	on pc-board
Soldering conditions:	wave soldering, max. 5 s max. 260 °C, pre-heat max. 60 s max. 100 °C
Travel:	2.4 mm ± 0.3 mm

3

Models: Switching function

TM 81 FW-RA off - mom

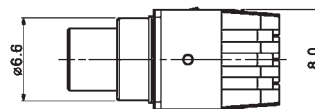
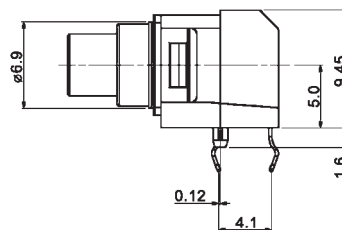
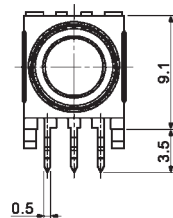
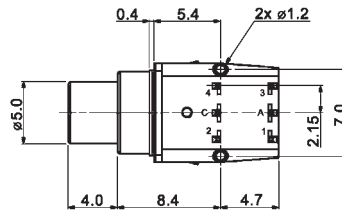

P.C.B. Layout

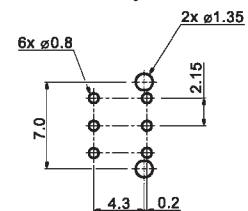

Ordering Code:

TM 81 F - RA

LEDs:

- without LED
- W white B blue
- R red YG yellow/green
- Y yellow RG red/green
- G green BA blue/amber

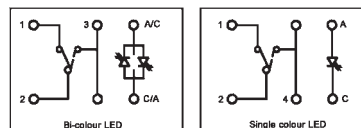

Illuminated Pushbutton Switches

Specifications:

Contact rating:	250 V AC, 3 A / 125 V AC, 3 A 30 V DC, 3 A
Contact resistance:	< 50 mΩ
Insulation resistance:	> 100 MΩ at 500 V DC
Dielectric strength:	1500 V, 50 Hz for the duration of 1 minute
Operating temperature:	- 25 °C to + 70 °C
Mechanical life:	minimum 30 000 operations
Contacts/Terminals:	solder tags or PC terminals, brass, silver-plated also available gold-plated, version B (see page 4)
Case material:	PA, black
Mounting:	single-hole mounting or on pc-board
Soldering conditions:	hand-soldering – max.: 30 W, 5 sec, 270 °C auto-soldering – max.: 3 sec, 245 °C ± 10 °C

Models: Switching functions

D P D T

LP 2 SR. – PC on – mom

LP 2 SN. – PC on – on

Illumination by **one** LED

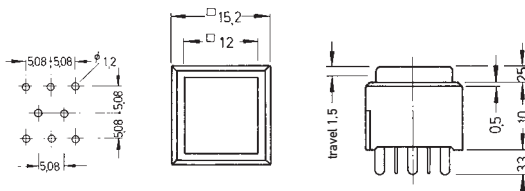

D P D T

LP 2 SR. on – mom

LP 2 SN. on – on

Illumination by **one** LED

R (LED red)
G (LED green)
Y (LED yellow)

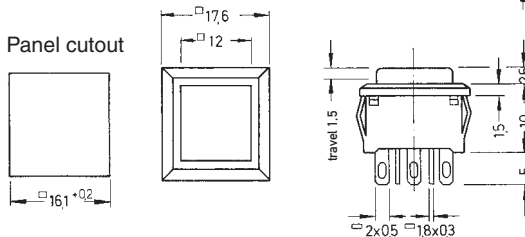

D P D T

LP 2 WR. – PC on – mom

LP 2 WN. – PC on – on

Illumination by **two** LEDs

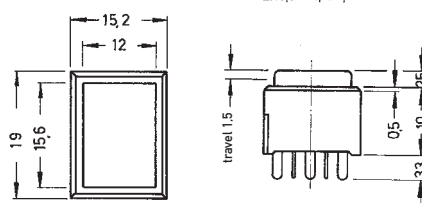

D P D T

LP 2 WR. on – mom

LP 2 WN. on – on

Illumination by **two** LEDs

R (LED red)
G (LED green)
Y (LED yellow)

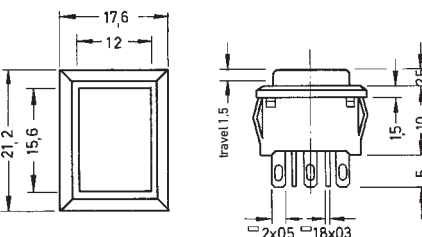

LP 2 .. R: I_F = 30 mA; U_F = 2,0 V
LP 2 .. G: I_F = 20 mA; U_F = 1,95 V
LP 2 .. Y: I_F = 20 mA; U_F = 1,9 V

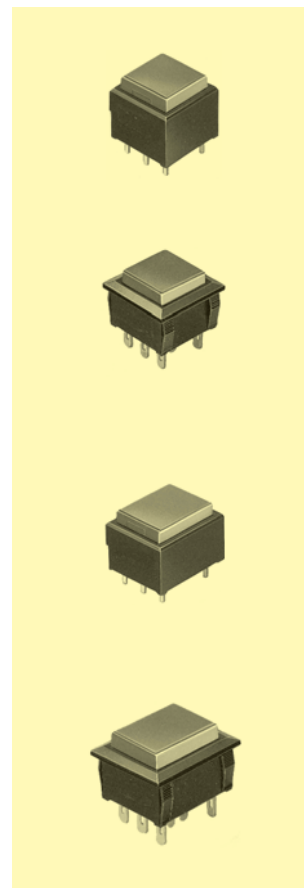
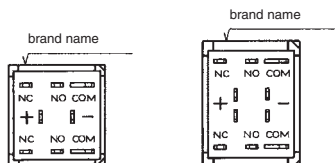



Illuminated Pushbutton Switches

Specifications:

Contact rating:	12 V DC, 100 mA
Contact resistance:	< 20 mΩ
Insulation resistance:	> 100 MΩ
Dielectric strength:	600 V, 50 Hz for the duration of 1 minute
Operating temperature:	-25 °C to +50 °C
Operating force:	180 gf ± 50 gf
Mechanical life:	minimum 500 000 operations
Material:	Contacts: Brass, Gold-plated Terminals: Phosphor-Bronze, Tin-plated Case: PA66 Cap, diffusor: PC
Mounting:	on pc-board
Soldering conditions:	LP 14...: IR-reflow-soldering, LP 14...-PC: wave soldering; max. 5 s max. 260 °C, pre-heat max. 60 s max. 100 °C
Travel:	Operating point 2.9 mm, total travel 4.3 mm
Individual Marking:	possible by polyester-film inlay, recommended size 12.8 mm x 12.8 mm x 0.1 mm

3

Models: Switching functions

D P D T
LP 14 CG RGBW-PC off – mom

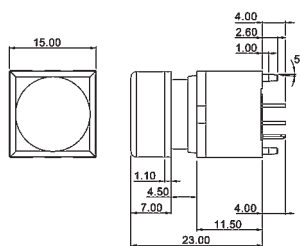

LP 14 CG RGBW off – mom

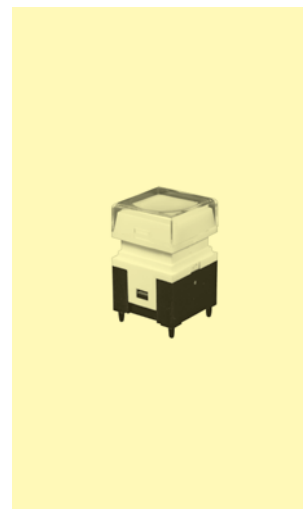
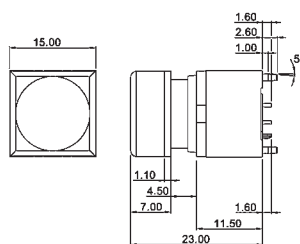

pin-assignment

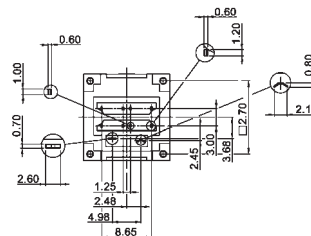
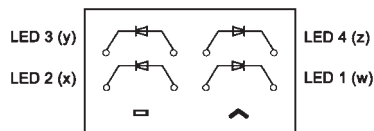

Ordering code: LP 14 CG □ □ □ □ – □

- | | |
|--------------------|--------------------------------------|
| LED colour: | Terminals: |
| □ without LED | -PC on pc-board (for auto-soldering) |
| W white | □ short terminals (THR) |
| Y yellow | |
| R red | |
| G green | |
| B blue | |

Illuminated Pushbutton Switches

Specifications:

Contact rating:	24 V DC, 50 mA
Contact resistance:	< 100 mΩ
Insulation resistance:	> 100 MΩ
Dielectric strength:	500 V, 50 Hz for the duration of 1 minute
Operating temperature:	-25 °C to +70 °C
Operating force:	1.6 N ± 0.2 N
Mechanical life:	minimum 500 000 operations
Material:	Contacts: stainless steel Terminals: brass, silver plated Case: PBT, UL 94 V-0, white Actuator: PC
Mounting:	on pc-board
Soldering conditions:	wave soldering, max. 5 s max. 260 °C, pre-heat max. 60 s max. 100 °C
Travel:	0.25 mm +0.2/-0.1 mm

Models: Switching functions

LP 10 B 02GA11 off - mom

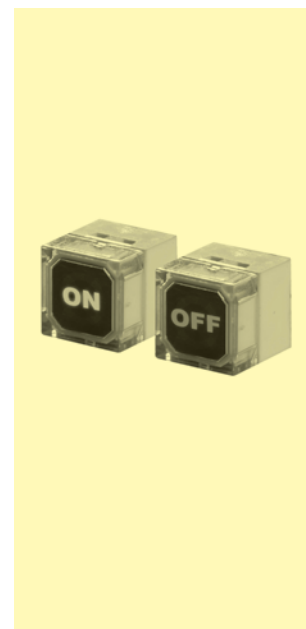
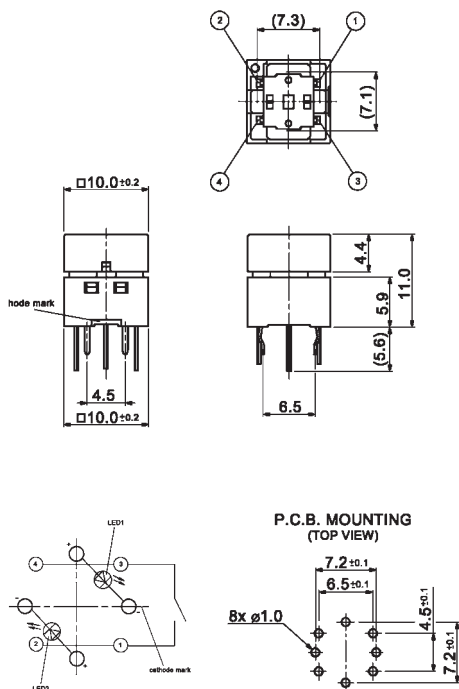

Ordering Code:

LP 10 <input type="checkbox"/> <input type="checkbox"/> 2 <input type="checkbox"/> A1 <input type="checkbox"/>			
Contact material:	Actuator:	LEDs:	Inlay:
<input type="checkbox"/> silver	<input type="checkbox"/> highly	<input type="checkbox"/> B red/blue	<input type="checkbox"/> 0 without inscription
<input type="checkbox"/> B gold	<input type="checkbox"/> transparently	<input type="checkbox"/> G red/green	<input type="checkbox"/> 1 OFF (red) and ON (second colour)
	<input type="checkbox"/> 1 white transparent		<input type="checkbox"/> 2 切 (rot) und 入 (second colour)
			<input type="checkbox"/> 3 X (red) and O (second colour)



Illuminated Pushbutton Switches for SMT

Specifications:

Contact rating:	12 V DC, 50 mA
Contact resistance:	< 100 mΩ
Insulation resistance:	> 100 MΩ
Dielectric strength:	250 V AC (50–60 Hz) for 1 minute
Operating temperature:	– 20 °C to + 70 °C
Operating force:	1,6 N + 0,8/–0,3 N
Mechanical life:	minimum 50 000 operations
Stem/cover:	high-temp. PA 9T UL 94 V–0, white
Terminal:	brass, silver-plated
Contact:	stainless steel, silver-plated
Base:	high-temp. PA 9T UL 94 V–0, molded black

Models:

TSSL 3W □ □

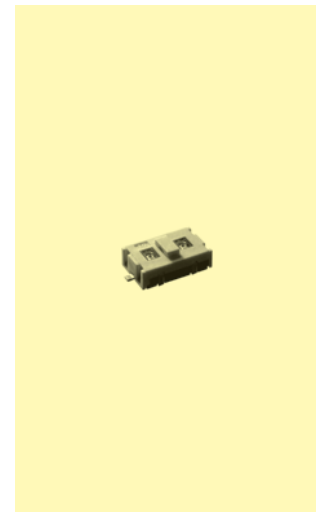
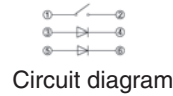
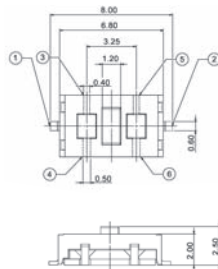
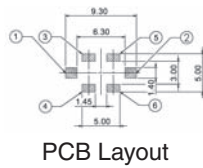

TSSL 3W □ □

Left LED:

- Ⓡ red
- Ⓞ green
- Ⓞ soft orange
- Ⓜ white
- Ⓟ blue

Right LED:

- Ⓡ red
- Ⓞ green
- Ⓞ soft orange
- Ⓜ white
- Ⓟ blue

Soldering conditions (reflow soldering)

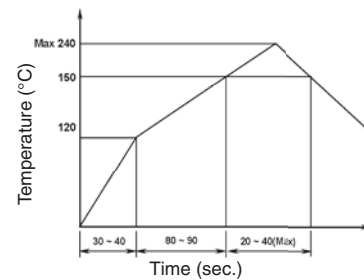

Illuminated Pushbutton Switches

Specifications:

Contacts:	TR = rubber contact TM = metal contact
Contact rating:	TR 12 V DC, 10 mA, TM 48 V DC, 50 mA max. 1 W
Contact resistance:	TR < 500 Ω at 1,5 N operating force TM < 100 mΩ at 2 N operating force
Insulation resistance:	> 100 MΩ at 100 V DC
Dielectric strength:	250 V, 50 Hz for the duration of 1 minute
Operating temperature:	- 25 °C to + 70 °C
Electrical life:	TR minimum 100 000 operations TM minimum 300 000 operations
Contacts:	TR rubber contact bridge; fixed contact phosphor bronze, gold-plated TM stainless steel, silver-plated
Terminals:	PC terminals, TR gold-plated; TM silver-plated
Travel:	TR 1 mm; TM 0,25 mm
Material:	button: PBT; case: TR: PA meets UL 94 V-0, TM: 6T PA resin; caps: ABS
Mounting:	on pc-board
Soldering conditions:	TR: auto-soldering – max.: 3 sec, 245 °C ± 10 °C TM: auto-soldering – max.: 5 sec, 300 °C

Models: Switching functions

without LED

TR 1
TM 1 off – mom

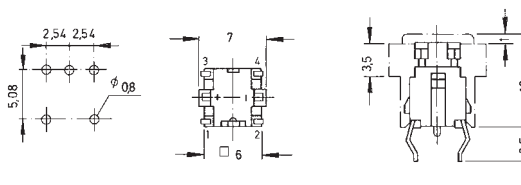

with LED

TR 2 – L.
TM 2 – L. off – mom
– LR (LED red)
– LG (LED green)
– LY (LED yellow)

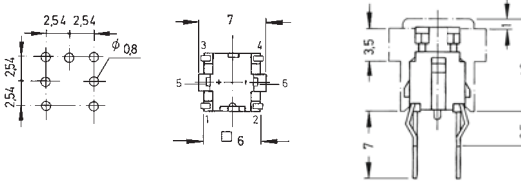

TR 3 – L.
TM 3 – L. off – mom
– LR (LED red)
– LG (LED green)
– LY (LED yellow)

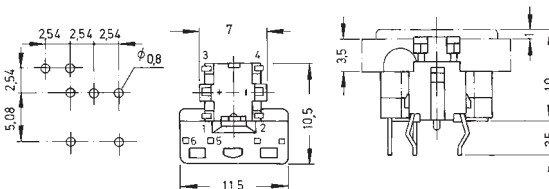

Circuit diagram:

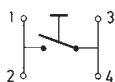

TR/TM 2-LR: I_F = 20 mA; U_F = 2,0 V
TR/TM 2-LG: I_F = 10 mA; U_F = 1,95 V
TR/TM 2-LY: I_F = 10 mA; U_F = 1,90 V
TR/TM 3-L: I_F = 10 mA; U_F = 2,1 V

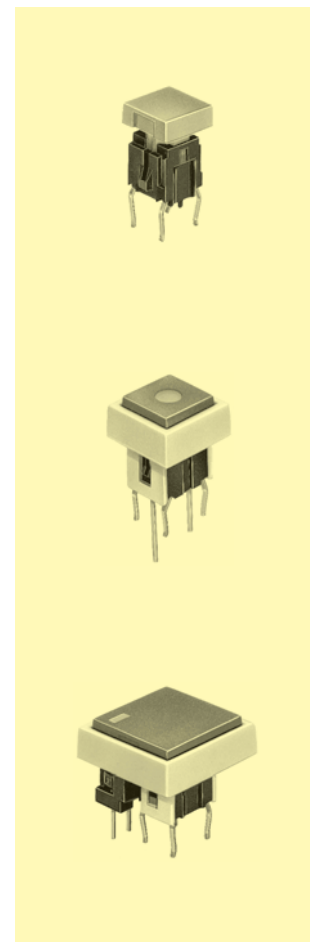



Illuminated Pushbutton Switches

Accessories:

	TR 1 / TM 1	TR 2 / TM 2	TR 1 / TM 1	TR 1 / TM 1	TR 3 / TM 3
Caps					
dark grey	KT 1017	KT 1117	KT 2017	KT 3017	KT 3117
grey	KT 1007	KT 1107	KT 2007	KT 3007	KT 3107
light grey	KT 1027	KT 1127	KT 2027	KT 3027	KT 3127
ivory	KT 1011	KT 1111	KT 2011	KT 3011	KT 3111
silver	KT 1021	KT 1121	KT 2021	KT 3021	KT 3121
red	KT 1009	KT 1109	KT 2009	KT 3009	KT 3109
blue	KT 1004	KT 1104	KT 2004	KT 3004	KT 3104
brown	KT 1002	KT 1102	KT 2002	KT 3002	KT 3102

Bezels

dark grey	FM 1017	FM 2017	FM 3017
grey	FM 1007	FM 2007	FM 3007
light grey	FM 1027	FM 2027	FM 3027
ivory	FM 1011	FM 2011	FM 3011

Mounting dimensions

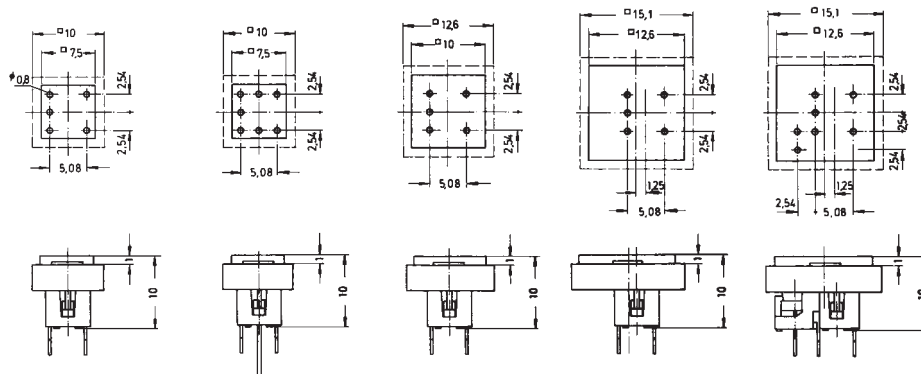

Illuminated Pushbutton Switches

Specifications:

Contacts:	LTR = rubber contact LTM = metal contact
Contact rating:	LTR 12 V DC, 10 mA LTM 48 V DC, 50 mA max. 1 W
Contact resistance:	LTR < 500 Ω at 2 V DC, 1 mA, at 1,5 N operating force LTM < 100 mΩ at 200 μV AC, 1,5 mA, at 2 N operating force
Insulation resistance:	> 100 MΩ
Dielectric strength:	250 V, 50 Hz for the duration of 1 minute
Operating temperature:	- 25 °C to + 70 °C
Mechanical life:	LTR minimum 100 000 operations LTM minimum 300 000 operations
Contacts:	LTR rubber contact bridge fixed contact phosphor bronze, gold-plated LTM stainless steel, silver-plated
Terminals:	LTR gold-plated LTM silver-plated
Travel:	LTR 1 mm LTM 0,25 mm
Material:	case: PBT meets UL 94 V-0 caps: LTR/LTM 1: ABS LTR/LTM 2: polycarbonat
Soldering conditions:	LTR: auto-soldering – max.: 3 sec, 245 °C ± 10 °C LTM: auto-soldering – max.: 5 sec, 300 °C

Models: Switching functions

without LED

LTR 1

LTM 1

off – mom

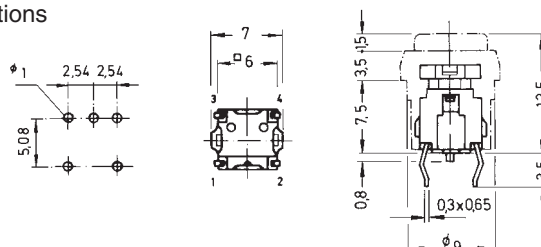

with LED

LTR 2 – L.

LTM 2 – L.

off – mom

- LR (LED red)
- LG (LED green)
- LY (LED yellow)

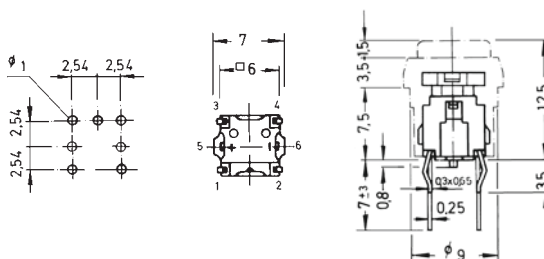

Circuit diagram:



LTR/LTM 2-LR: $I_F = 20 \text{ mA}$; $U_F = 2,0 \text{ V}$
LTR/LTM 2-LG: $I_F = 10 \text{ mA}$; $U_F = 1,95 \text{ V}$
LTR/LTM 2-LY: $I_F = 10 \text{ mA}$; $U_F = 1,90 \text{ V}$





Illuminated Pushbutton Switches

Accessories:

Caps

LTR 1/LTM 1

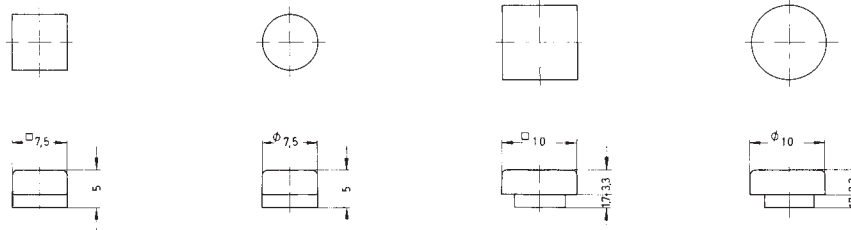

dark grey	KT 7317	KT 7217	KT 8317	KT 8217
grey	KT 7307	KT 7207	KT 8307	KT 8207
light grey	KT 7327	KT 7227	KT 8327	KT 8227
red	KT 7309	KT 7209	KT 8309	KT 8209

3

LTR 2/LTM 2

transparent:

clear	KT 7390	KT 7290	KT 8390	KT 8290
red	KT 7399	KT 7299	KT 8399	KT 8299
green	KT 7396	KT 7296	KT 8396	KT 8296
yellow	KT 7398	KT 7298	KT 8398	KT 8298

Bezels*

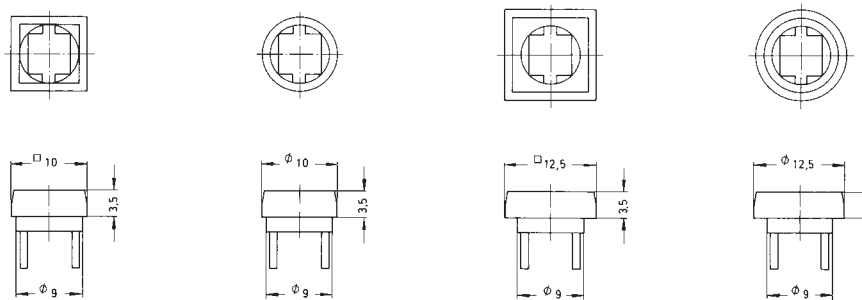

dark grey	FM 7317	FM 7217	FM 8317	FM 8217
grey	FM 7307	FM 7207	FM 8307	FM 8207

* further colours on request

Illuminated Pushbutton Switches

Specifications:

Contact rating:	30 V DC, 0,1 A
Contact resistance:	< 50 mΩ
Insulation resistance:	> 100 MΩ at 500 V DC
Dielectric strength:	500 V, 50 Hz for the duration of 1 minute
Operating temperature:	- 10 °C to + 70 °C
Mechanical life:	minimum 10 000 operations
Contacts/Terminals:	PC terminals, phosphor bronze, silver-plated
Travel:	1,5 mm
Case material:	PBT meets UL 94 V-0
Mounting:	on pc-board
Soldering conditions:	auto-soldering – max.: 3 sec, 245 °C ± 10 °C

Models: Switching functions

D P D T

without LED

TP 2 R	on – mom
TP 2 N	on – on

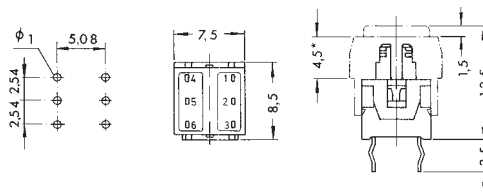

* 10 mm bezel = 3,8 mm

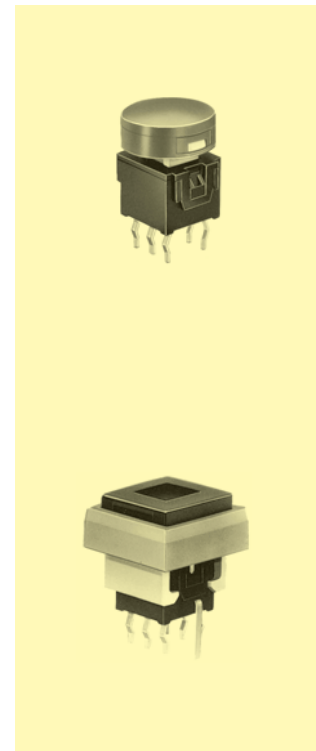

D P D T

with LED

TP 2 R – L.	on – mom
TP 2 N – L.	on – on
– LR (LED red)	
– LG (LED green)	
– LY (LED yellow)	

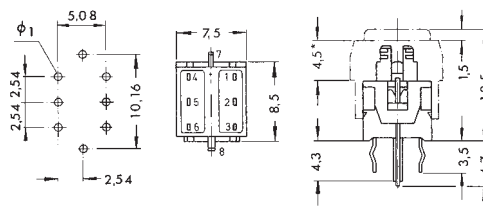

* 10 mm bezel = 3,8 mm

Circuit diagram:



TP 2.-LR: I_F = 20 mA; U_F = 2,0 V

TP 2.-LG: I_F = 15 mA; U_F = 1,95 V

TP 2.-LY: I_F = 15 mA; U_F = 1,9 V





Illuminated Pushbutton Switches

Accessories:

Caps

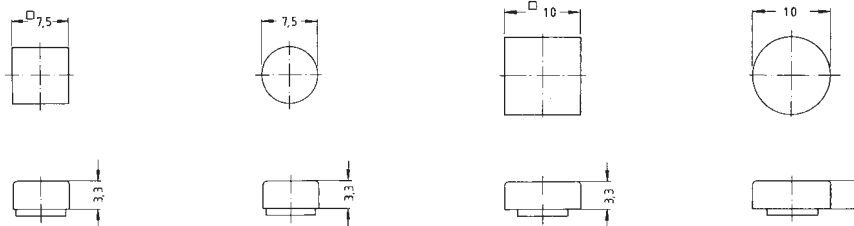

opaque:

dark grey	KT 5317	KT 5217	KT 6317	KT 6217
grey	KT 5307	KT 5207	KT 6307	KT 6207
light grey	KT 5327	KT 5227	KT 6327	KT 6227
ivory	KT 5311	KT 5211	KT 6311	KT 6211
red	KT 5309	KT 5209	KT 6309	KT 6209
green	KT 5306	KT 5206	KT 6306	KT 6206
blue	KT 5304	KT 5204	KT 6304	KT 6204

transparent:

frame	—	—	grey	ivory	grey	ivory
window:						
red	KT 5399	KT 5299	KT 6389	KT 6399	KT 6289	KT 6299
green	KT 5396	KT 5296	KT 6386	KT 6396	KT 6286	KT 6296
yellow	KT 5398	KT 5298	KT 6388	KT 6398	KT 6288	KT 6298

Bezels

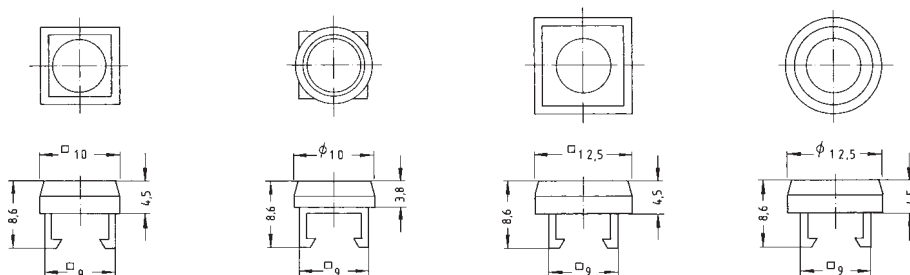

dark grey	FM 5317	FM 5217	FM 6317	FM 6217
grey	FM 5307	FM 5207	FM 6307	FM 6207
light grey	FM 5327	FM 5227	FM 6327	FM 6227
ivory	FM 5311	FM 5211	FM 6311	FM 6211

Anti-Vandal Pushbutton Switches



Specifications:

Insulation resistance:	> 1000 MΩ at 500 V DC
Operating temperature:	– 20 °C to + 55 °C
Switching force:	off – mom
Material:	Contact: silver plated alloy Nut: nickel plated brass

Models:

MAV 01 B1M1

Rating:	125 V AC, 2 A / 48 V DC, 2 A
Contact resistance:	<10 mΩ
Dielectric strength:	3000 V, 50 Hz (1 min.)
Electrical life:	10 000 cycles

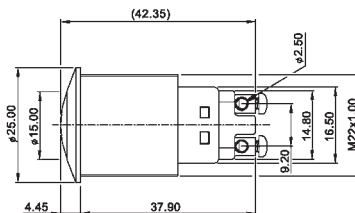

MAV 01 B2M1R

Rating:	36 V DC, 2 A
Contact resistance:	< 50 mΩ
Dielectric strength:	2000 V, 50 Hz (1 min.)
Electrical life:	200 000 cycles
Protection:	IP 65

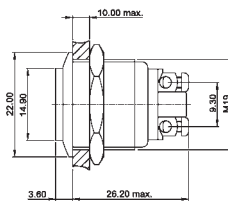

MAV 01 B32M3F

Rating:	36 V DC, 2 A
Contact resistance:	< 50 mΩ
Dielectric strength:	2000 V, 50 Hz (1 min.)
Electrical life:	200 000 cycles
Protection:	IP 65

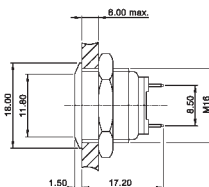

Ordering code:

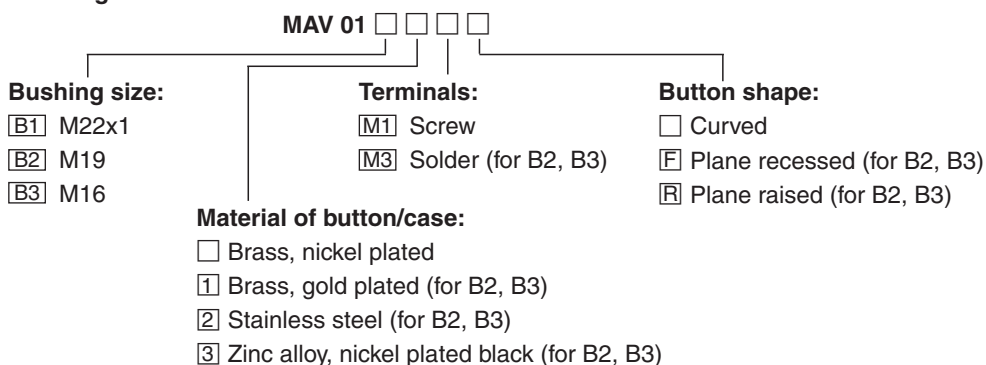



Anti-Vandal Pushbutton Switches waterproof, illuminated

Specifications:

Contact resistance:	< 50 mΩ
Insulation resistance:	> 1000 MΩ at 500 V DC
Dielectric strength:	2000 V RMS (50/60 Hz)
Operating temperature:	- 20 °C to + 55 °C
Electrical life:	50 000 cycles
Operating force:	5.5 N max.
Protection:	IP 67
Material:	Nut: nickel plated brass Base: PBT

Models:

MAV 02 LB22M3FDY6V
Rating: 250 V AC, 5 A

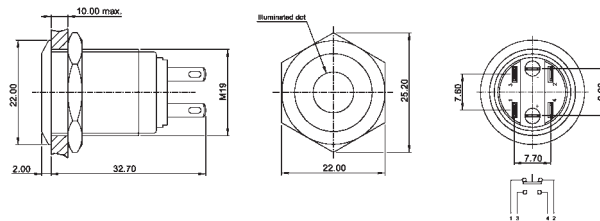

MAV 22 LB2M3FRBLO12V
Rating: 250 V AC, 5 A

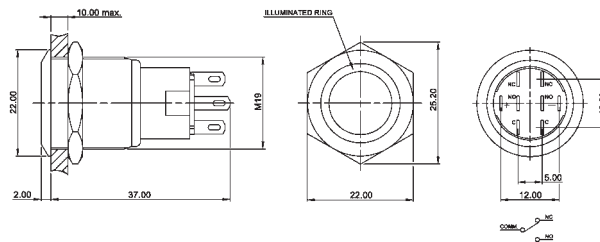

MAV 02 LB3M3RDO36V
Rating: 250 V AC, 3 A

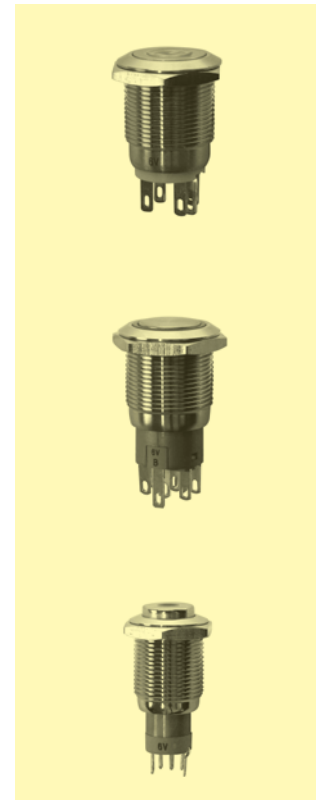
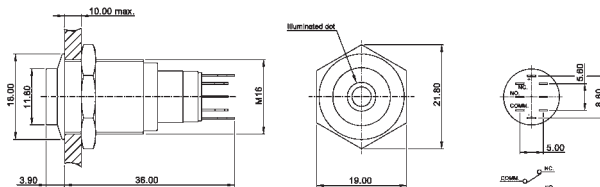

Ordering code:

MAV M3

Number of poles:
 Single pole
 Double pole

Switching function:
 on – mom
 on – on

Illumination:
 Without
 LED

Bushing size:
 B2 M19
 B3 M16

Material of button/case:
 Brass, nickel plated (for B3)
 1 Brass, gold plated (for B3)
 2 Stainless steel
 3 Zinc alloy, nickel plated, black

Button shape:
 F Recessed
 R Raised

Contact material:
 Silver alloy
 G Gold over silver alloy

LED color:
 Without LED
 R Red
 G Green
 Y Yellow
 O Orange
 B Blue
 W White

Lens style:
 Without LED
 D Dot illumination
 R Ring illumination

LED voltage (AC/DC):
 without LED
 6V 6 V, 15 mA
 12V 12 V, 15 mA
 24V 24 V, 15 mA
 36V 36 V, 5 mA
 110V 110 V, 5 mA
 220V 220 V, 5 mA

Contact arrangement:
 Separate NO and NC contacts, short body (for B2, single pole)
 Changeover contact (for B3)
 LO Changeover contact, long body (for B2)

knitter-switch | 71

Specifications:

Contact rating:	24 V DC, 20 mA; max. 0,5 W
Contact resistance:	< 100 mΩ
Insulation resistance:	> 1000 MΩ at 100 V DC
Dielectric strength:	250 V, 50 Hz for the duration of 1 minute
Operating temperature:	- 40 °C to + 85 °C
Mechanical life:	minimum 1 000 000 operations
Contacts:	gold-plated over nickel barrier
Travel:	0,75 ±0,25 mm
Operating force:	4,5 ±1,0 N
Terminals:	PC terminals, tin-plated over nickel barrier
Material:	case: PBT (UL 94 V-0), blue, TMP 1-1: red button: silicon rubber, ivory; caps: PC meets UL 94 V-0
Protection:	IP 67
Mounting:	on pc-board
Soldering conditions:	auto-soldering – max.: 5 sec, 270 °C

Models: Switching functions

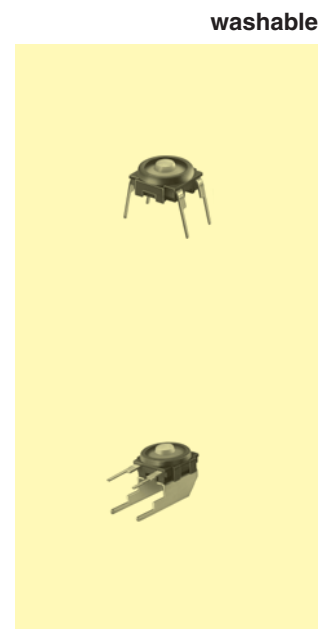
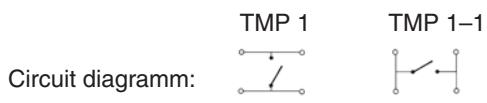
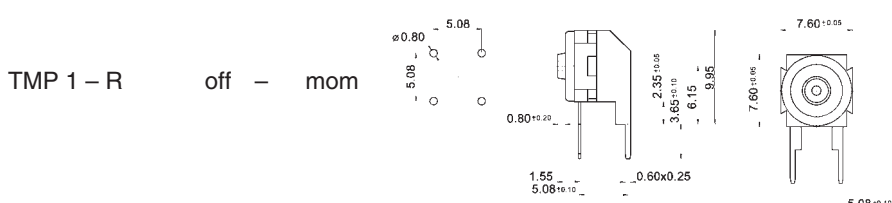
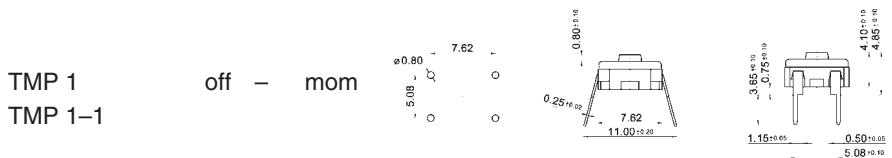

Accessories and mounting dimensions:

Caps
light grey KTT 107

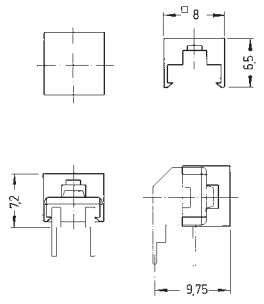

dark grey KTT 217
light grey KTT 227
red KTT 209

(More colours in request, MOQ 25 K)

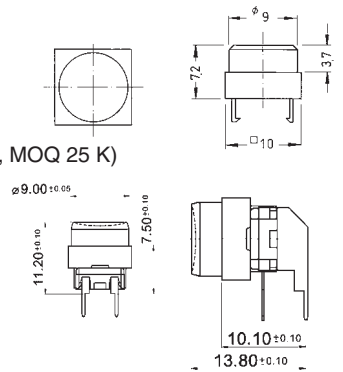

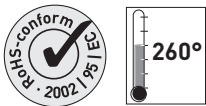

Tact Switches for SMT, waterproof

Specifications:

Contact rating:	24 V DC, 20 mA; max. 0,5 W
Contact resistance:	< 100 mΩ
Insulation resistance:	> 1000 MΩ at 100 V DC
Dielectric strength:	250 V, 50 Hz for the duration of 1 minute
Operating temperature:	- 40 °C to + 85 °C
Mechanical life:	minimum 1 000 000 operations
Contacts:	gold-plated over nickel barrier
Travel:	0,75 ±0,25 mm
Operating force:	4,5 ±1,0 N
Terminals:	tin-plated over nickel barrier
Material:	case: PA meets UL 94 V-0, black, TMPS 1-1: white button: silicon rubber, ivory
Protection:	IP 67
Mounting:	on pc-board, SMD

3

Models: Switching functions

TMPS 1 off - mom

TMPS 1-1

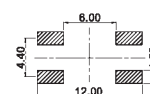
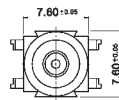
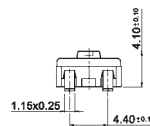
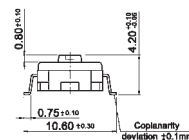

Layout



Circuit diagramm:



Packing:

TMPS 1, TMPS 1-1 50 pieces in stick

TMPS 1T, TMPS 1-1T 1 100 pieces/reel

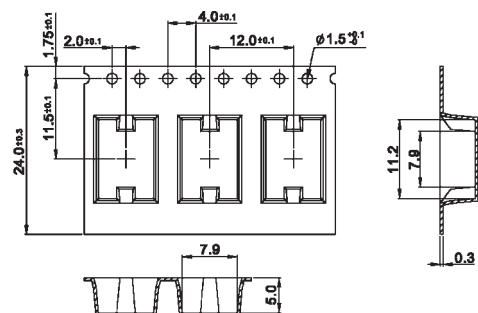

Tact Switches

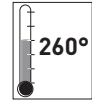

Specifications:

Contact rating:	42 V AC/DC, 100 mA
Contact resistance:	< 100 mΩ
Insulation resistance:	> 1000 MΩ bei 100 V DC
Dielectric strength:	250 V DC, 50 Hz for the duration of 1 minute
Operating temperature:	-40 °C to +80 °C
Mechanical life:	1 000 000 operations
Contacts:	gold-plated
Terminals:	terminal pin, copper alloy, gold-plated
Material:	case: PA6, washable button: TPE-S
Mounting:	on PC-board, TSSE 12 S: SMD

Models:

Switching functions

TSE 8 S

off - mom

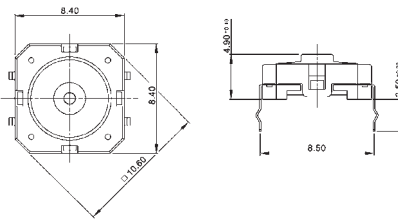
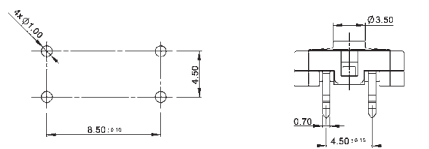

TSE 8 S-1

off - mom

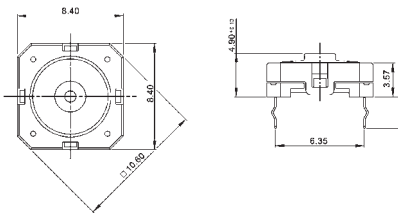
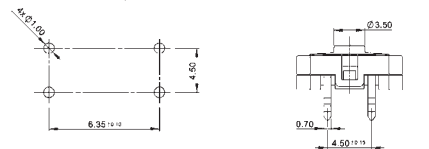

TSSE 8 S

off - mom

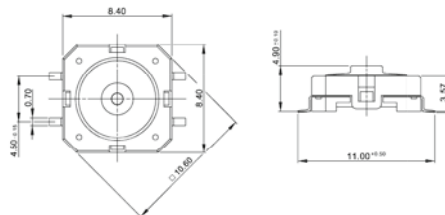
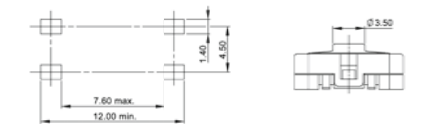

washable



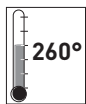

Tact Switches

Specifications:

Contact rating:	42 V AC/DC, 100 mA
Contact resistance:	< 100 mΩ
Insulation resistance:	> 1000 MΩ bei 100 V DC
Dielectric strength:	250 V DC, 50 Hz for the duration of 1 minute
Operating temperature:	-40 °C to +80 °C
Mechanical life:	1 000 000 operations
Contacts:	gold-plated
Terminals:	terminal pin, copper alloy, gold-plated
Material:	case: PA46 / PA6T, washable button: silicon caoutchouc
Mounting:	on PC-board, TSSE 12 S: SMD

3

washable

Models:

Switching functions

TSE 12 S

off - mom

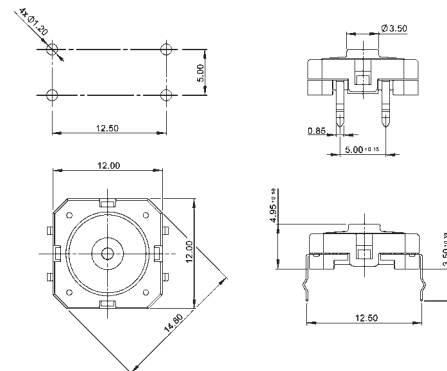

TSE 12 S-1

off - mom

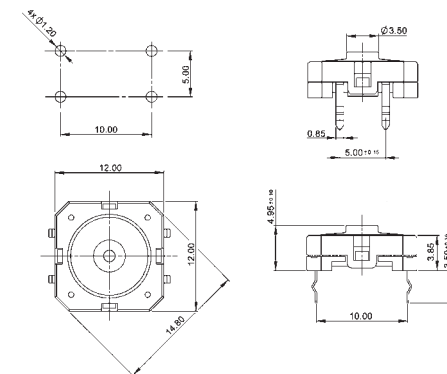

TSSE 12 S

off - mom

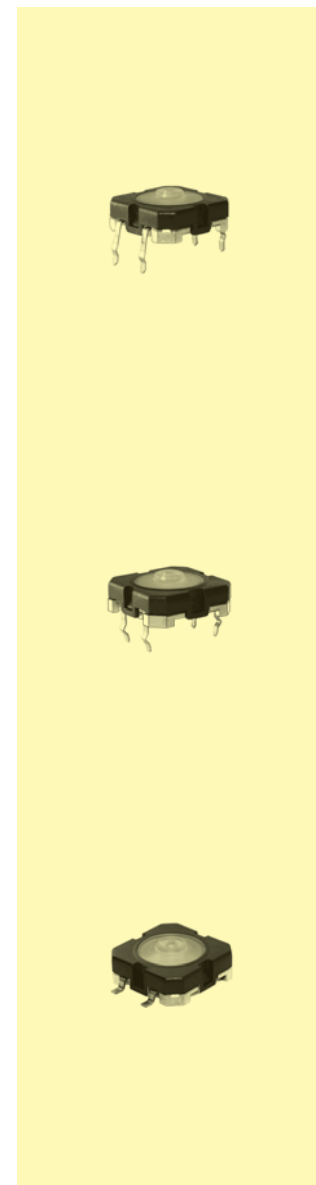
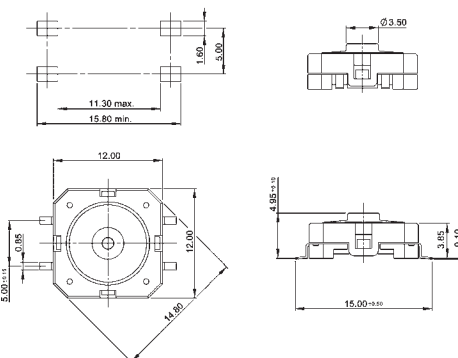

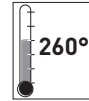

Specifications:

Contact rating:	12 V DC, 50 mA
Contact resistance:	< 100 mΩ
Insulation resistance:	> 100 MΩ at 500 V DC
Dielectric strength:	250 V, 50 Hz for the duration of 1 minute
Operating temperature:	- 40 °C to + 85 °C
Electrical life:	TSSE 66/68 minimum 100 000 cycles TSSE 65/67/69 minimum 500 000 cycles
Operating force:	see ordering code
Contacts:	phosphor bronze, silver-plated
Terminals:	brass, silver-plated
Material:	cover: stainless steel base: high-temp. nylon meets UL 94 V-0, washable stem: TSSE 66: nylon – TSSE 65/67/68/69: silicone rubber
Protection:	IP 57
Mounting:	on pc-board – SMD
Packing:	on tapes – see ordering code

Models:

TSSE 66

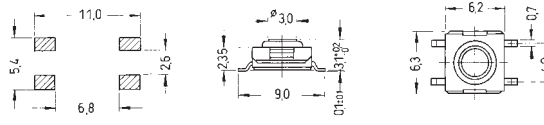

PCB Layout

TSSE 68

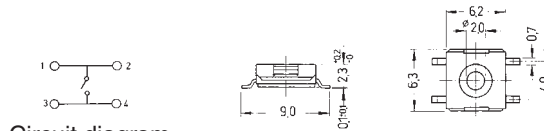

Circuit diagram

TSSE 65

TSSE 67

TSSE 69

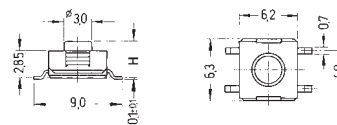

washable

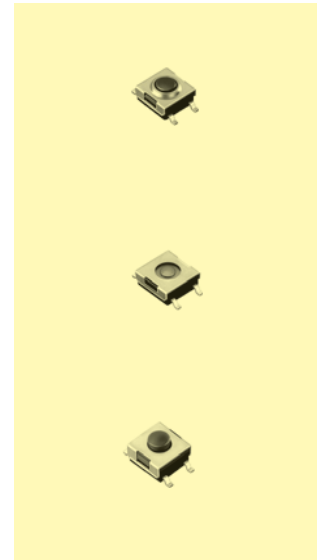

Ordering code:

TSSE

Dimension H

<input type="checkbox"/> 5	3,5 mm, travel: 0,45 ± 0,2	brown	(N) / 1900 pieces/reel
<input type="checkbox"/> 5	3,5 mm, travel: 0,45 ± 0,2	red	(R) / 1900 pieces/reel
<input type="checkbox"/> 5	3,5 mm, travel: 0,45 ± 0,2	transparent	(T) / 1900 pieces/reel
<input type="checkbox"/> 6	3,1 mm, travel: 0,25 + 0,2/- 0,1	brown	(N) / 2000 pieces/reel
<input type="checkbox"/> 7	5,2 mm, travel: 0,45 ± 0,2	brown	(N) / 900 pieces/reel
<input type="checkbox"/> 7	5,2 mm, travel: 0,45 ± 0,2	red	(R) / 900 pieces/reel
<input type="checkbox"/> 7	5,2 mm, travel: 0,6 ± 0,2	transparent	(T) / 900 pieces/reel
<input type="checkbox"/> 8	2,3 mm, travel: 0,25 + 0,2/- 0,1	silver	(S) / 2000 pieces/reel
<input type="checkbox"/> 9	3,8 mm, travel: 0,45 ± 0,2	red	(R) / 1900 pieces/reel
<input type="checkbox"/> 9	3,8 mm, travel: 0,45 ± 0,2	brown	(N) / 1900 pieces/reel
<input type="checkbox"/> 9	3,8 mm, travel: 0,6 ± 0,2	transparent	(T) / 1900 pieces/reel

Colour of stem

for operating force:

<input type="checkbox"/> S	1,6 N, silver
<input type="checkbox"/> N	1,6 N, brown
<input type="checkbox"/> R	2,6 N, red
<input type="checkbox"/> T	3,6 N, transparent

further types on request

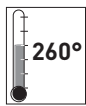

Tact Switches for SMT

Specifications:

Contact rating:	12 V DC, 50 mA
Contact resistance:	< 100 mΩ
Insulation resistance:	> 100 MΩ at 500 V DC
Dielectric strength:	250 V, 50 Hz for the duration of 1 minute
Operating temperature:	- 40 °C to + 85 °C
Electrical life:	TSSE 66-J/68-J: minimum 100 000 cycles TSSE 65-J/67-J/69-J: minimum 500 000 cycles
Operating force:	see ordering code
Contacts:	phosphor bronze, silver-plated
Terminals:	brass, silver-plated
Material:	cover: stainless steel base: high-temp. nylon meets UL 94 V-0, washable stem: TSSE 66 J: nylon – TSSE 65/67/68/69 J: silicone rubber
Protection:	IP 57
Mounting:	on pc-board – SMD
Packing:	on tapes – see ordering code

3

Models:

TSSE 66 □-J

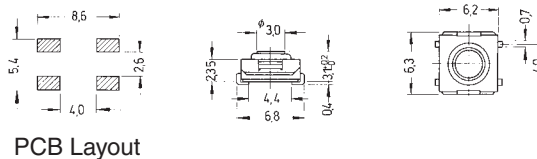

TSSE 68 □-J

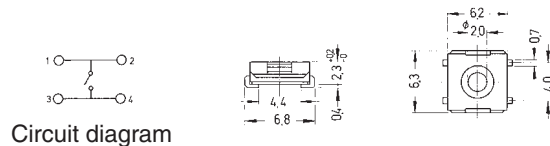

TSSE 65 □-J

TSSE 67 □-J

TSSE 69 □-J

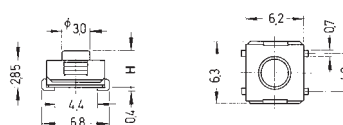

washable

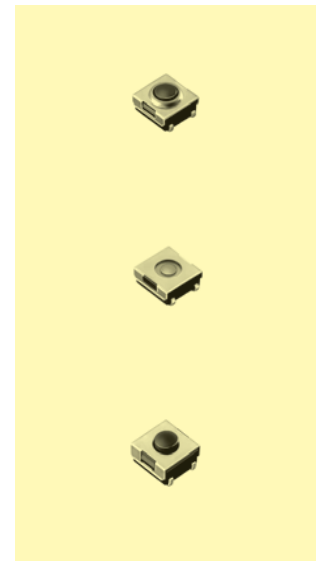

Ordering code:

TSSE □ □-J

Dimension H

65	3,5 mm, travel: 0,45 ± 0,2	brown	(N) / 1800 pieces/reel
65	3,5 mm, travel: 0,45 ± 0,2	red	(R) / 1800 pieces/reel
65	3,5 mm, travel: 0,45 ± 0,2	transparent	(T) / 1800 pieces/reel
66	3,1 mm, travel: 0,25 + 0,2/- 0,1	brown	(N) / 1900 pieces/reel
67	5,2 mm, travel: 0,45 ± 0,2	brown	(N) / 900 pieces/reel
67	5,2 mm, travel: 0,45 ± 0,2	red	(R) / 900 pieces/reel
67	5,2 mm, travel: 0,6 ± 0,2	transparent	(T) / 900 pieces/reel
68	2,3 mm, travel: 0,25 + 0,2/- 0,1	silver	(S) / 2700 pieces/reel
69	3,8 mm, travel: 0,45 ± 0,2	red	(R) / 1800 pieces/reel
69	3,8 mm, travel: 0,45 ± 0,2	brown	(N) / 1800 pieces/reel
69	3,8 mm, travel: 0,6 ± 0,2	transparent	(T) / 1800 pieces/reel

Colour of stem

for operating force:

S	1,6 N, silver
N	1,6 N, brown
R	2,6 N, red
T	3,6 N, transparent

further types on request

Tact Switches



Specifications:

Contact rating:	12 V DC, 50 mA
Contact resistance:	< 100 mΩ
Insulation resistance:	> 100 MΩ at 500 V DC
Dielectric strength:	250 V, 50 Hz for the duration of 1 minute
Operating temperature:	- 40 °C to + 70 °C
Electrical life:	TSE 66/68 minimum 100 000 cycles TSE 69 minimum 500 000 cycles
Operating force:	see ordering code
Contacts:	phosphor bronze, silver-plated
Terminals:	PC terminals brass, silver-plated
Material:	cover: stainless steel base: high-temp. nylon meets UL 94 V-0, washable stem: TSE 66: nylon – TSE 68/69: silicone rubber
Protection:	IP 57
Mounting:	on pc-board
Soldering conditions:	hand-soldering – max.: 30 W, 2 sec, 320 °C auto-soldering – max.: 5 sec, 260 °C subject to PCB 1,6 mm thickness
Packing:	75 pcs/tube

Models:

TSE 66 □

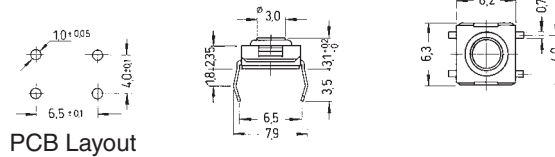

TSE 68 □

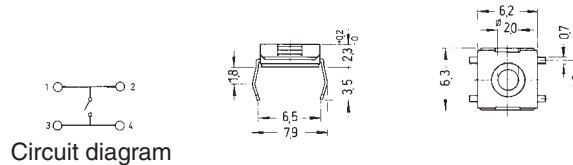

TSE 69 □

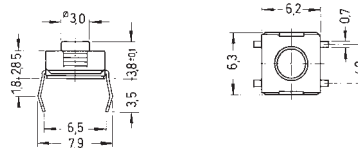

washable



Ordering code:

TSE □ □ □	
<p>Dimension</p> <p>66 3,1 mm, travel: 0,25 + 0,2/- 0,1 brown (N)</p> <p>68 2,3 mm, travel: 0,25 + 0,2/- 0,1 silver (S)</p> <p>69 3,8 mm, travel: 0,45 ± 0,2 red (R)</p> <p>69 3,8 mm, travel: 0,45 ± 0,2 brown (N)</p>	<p>Colour of stem for operating force:</p> <p>S 1,6 N, silver</p> <p>N 1,6 N, brown</p> <p>R 2,6 N, red</p>

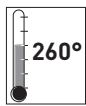

Tact Switches for SMT

Specifications:

Contact rating:	12 V DC, 50 mA
Contact resistance:	< 100 mΩ
Insulation resistance:	> 100 MΩ
Dielectric strength:	250 V AC (50 Hz or 60 Hz) for 1 minute
Operating temperature:	- 25 °C to + 70 °C
Operating force:	see ordering code
Mechanical life:	minimum 500 000 cycles
Cover:	nickel, silver-plated
Case:	high-temp. PA 9T UL 94 V-0, black
Stem:	silicone
Contacts:	phosphor bronze, silver-plated
Terminals:	brass, silver-plated
Protection:	IP 57
Packing:	on tapes – see ordering code

Models:

TSSE 6 □ □ -RA

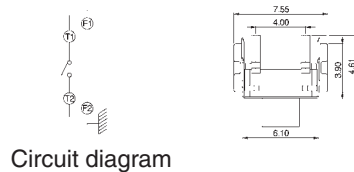
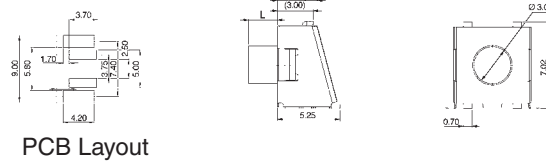

TSSE 6 □ □ -RA-1

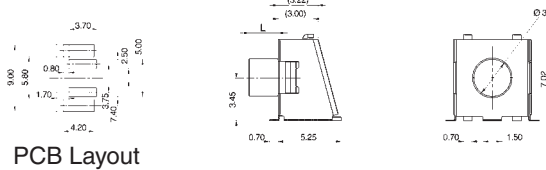

washable

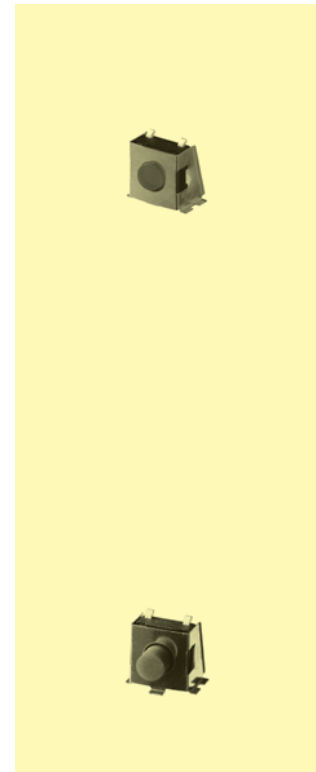

Ordering code:

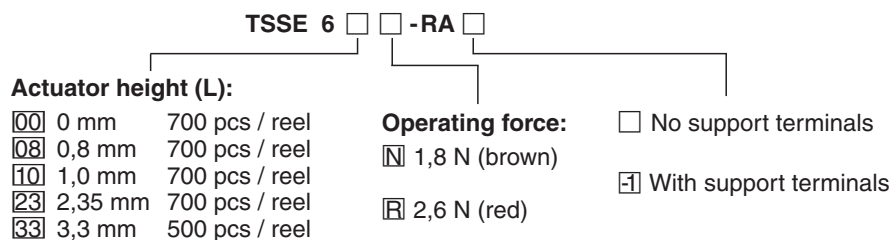

Further types on request

Specifications:

Contact rating:	TMS 1	48 V DC, 50 mA, max. 1 W
	TMS 3 / TMSE 3	24 V DC, 30 mA, max. 0,6 W
Contact resistance:		< 100 mΩ
Insulation resistance:		> 100 MΩ at 100 V DC
Dielectric strength:		250 V, 50 Hz for the duration of 1 minute
Operating temperature:		- 25 °C to + 70 °C
Mechanical life:		minimum 100 000 operations
Contacts:		silver-plated, terminals tin-plated; TMSE 3 with ground terminals
Material:	TMS 1	case: 6TPA resin; button: silicon, black; frame: stainless steel
	TMS 3	case: PA; button: PA, black; frame: stainless steel
	TMSE 3	case: PA washable; button: silicon, grey; frame: stainless steel
Operating force:	TMS 1 / TMSE 3	2,0 N
	TMS 3	1,2 N
Mounting:		on pc-board – SMD

Models: Switching functions

TMS 1
travel 0,5

off – mom

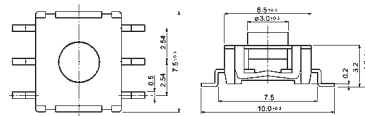

Circuit diagram:

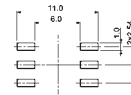

TMS 3
travel 0,25

off – mom

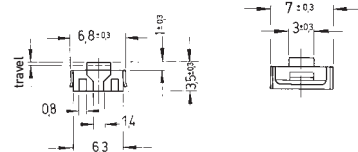

TMSE 3
travel 0,5

off – mom

Circuit diagram:

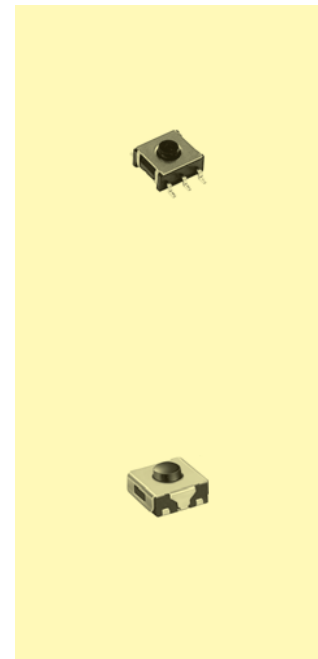
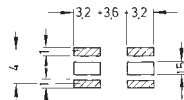

Soldering conditions: TMS1 reflow-soldering – max.: 40 sec, 230° C
peak temperature: 250° C
TMS3/TMSE3 reflow-soldering – max.: 40 sec., 230° C
peak temperature: 255° C

Packing see next page



Specifications:

Contact rating:	48 V DC, 50 mA, max. 1 W
Contact resistance:	< 100 mΩ
Insulation resistance:	> 100 MΩ at 100 V DC
Dielectric strength:	250 V, 50 Hz for the duration of 1 minute
Operating temperature:	- 25 °C to + 70 °C
Mechanical life:	minimum 300 000 operations
Contacts:	phosphor bronze, silver-plated
Terminals:	PC terminals
Material:	case: 6TPA resin, washable; frame: stainless steel button: perbunan, black
Operating force:	2,0 N
Mounting:	on pc-board
Soldering conditions:	auto-soldering – max.: 6 sec, 275 °C ± 10 °C

Models: Switching functions

TME 1

off – mom

Circuit diagram:

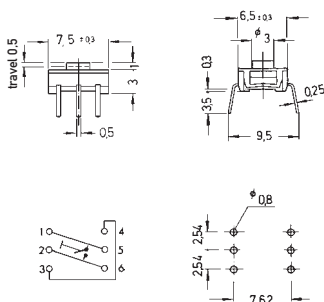

washable

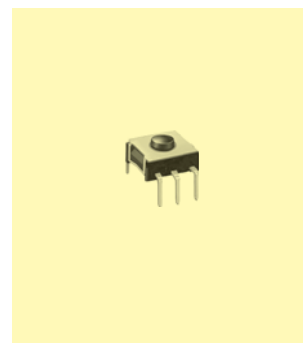

Packing series TMS (previous page): sticks or tapes
for order on tape: additional to type number: T
example of order: TMS 1 T

Models	Stick	Tape	Reel	Tape width	Rapport
				(A)	(R)
TMS 1	50 pieces; L 400 mm	1000 pieces	Ø 330 mm	24 mm	16 mm
TMS 3	50 pieces; L 375 mm	1000 pieces	Ø 330 mm	16 mm	12 mm
TMSE 3	50 pieces; L 375 mm	1000 pieces	Ø 330 mm	16 mm	12 mm

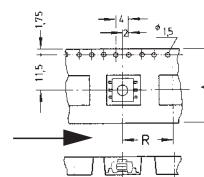

Tact Switches for SMT

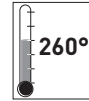

Specifications:

Contact rating:	12 V DC, 50 mA
Contact resistance:	< 100 mΩ
Insulation resistance:	> 100 MΩ at 500 V DC
Dielectric strength:	250 V, 50 Hz for the duration of 1 minute
Operating temperature:	- 25 °C to + 70 °C
Electrical life:	2,6 N: minimum 100 000 cycles 1,6 N: minimum 200 000 cycles
Operating force:	see ordering code
Contacts:	phosphor bronze, silver-plated
Terminals:	brass, silver-plated
Material:	cover: stainless steel base and stem: high-temp. nylon meets UL 94 V-0; caps ABS
Mounting:	on pc-board – SMD
Soldering conditions:	hand-soldering – max.: 30 W, 2 sec, 320 °C
Packing:	on tapes – see ordering code
Travel:	0,35 mm + 0,2/- 0,1 mm

Models:

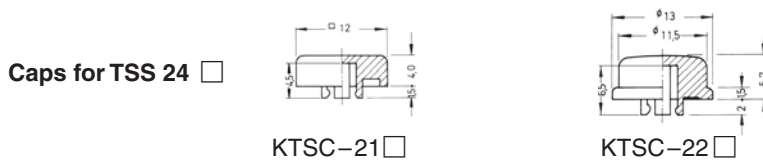
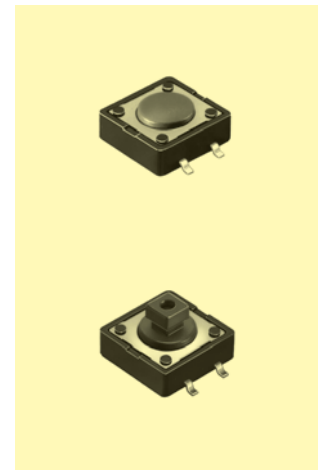
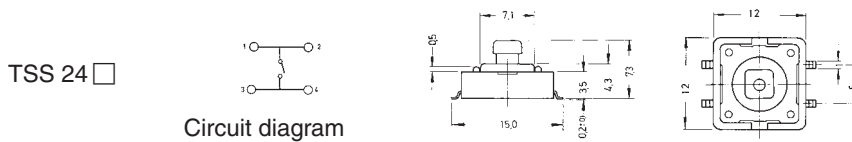
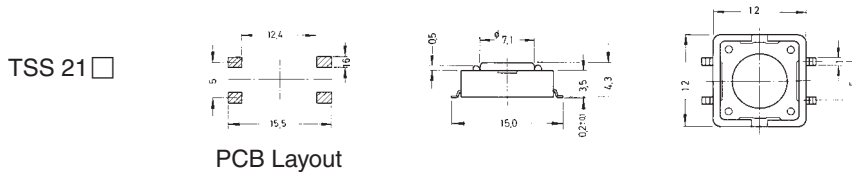

Ordering code:

Switches	TSS 2 □ □	Colour of stem for operating force:	Caps	KTSC-2 □ □	Cap colour:
Dimension / Packing:	□ 1 4,3 mm / 700 pcs/reel	□ 1,6 N, brown	Cap type:	□ 1 square	□ 1 yellow
	□ 4 7,3 mm / 500 pcs/reel	□ 2,6 N, red		□ 2 round	□ 2 blue
					□ 3 red
					□ 4 ivory
					□ 5 black
					□ 6 green



Tact Switches

Specifications:

Contact rating:	12 V DC, 50 mA
Contact resistance:	< 100 mΩ
Insulation resistance:	> 100 MΩ at 500 V DC
Dielectric strength:	250 V, 50 Hz for the duration of 1 minute
Operating temperature:	- 25 °C to + 70 °C
Electrical life:	2,6 N: minimum 100 000 cycles 1,6 N: minimum 200 000 cycles
Operating force:	see ordering code
Contacts:	phosphor bronze, silver-plated
Terminals:	PC terminals, brass, silver-plated
Material:	cover: stainless steel base and stem: nylon meets UL 94 V-0
Mounting:	on pc-board
Soldering conditions:	hand-soldering – max.: 30 W, 2 sec, 320 °C auto-soldering – max.: 5 sec, 260 °C subject to PCB 1,6 mm thickness
Travel:	0,35 mm + 0,2/- 0,1 mm

3

Models:

TS 21 □

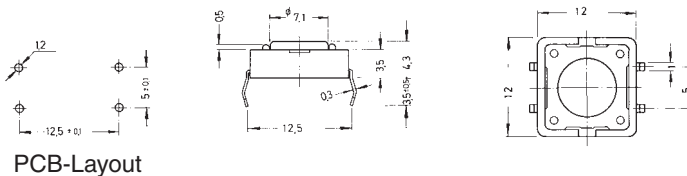

TS 24 □

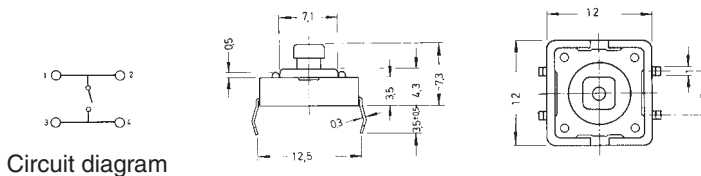

Caps for TS 24 □

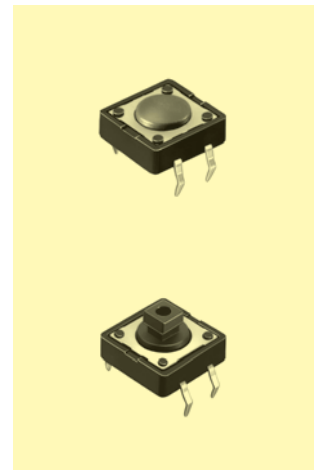
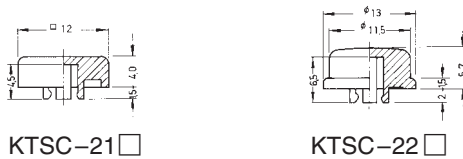

Ordering code:

Switches TS 2 □ □

Dimension:
 1 4,3 mm
 4 7,3 mm

Colour of stem
for operating force:
 N 1,6 N, brown
 R 2,6 N, red

Caps KTSC-2 □ □

Cap type:
 1 square
 2 round

Cap colour:
 Y yellow
 B blue
 R red
 I ivory
 K black
 G green

Tact Switches for SMT, waterproof



Specifications:

Contact rating:	50 V DC, 50 mA
Contact resistance:	<100 mΩ
Insulation resistance:	>1000 MΩ
Dielectric strength:	250 V, 50 Hz for the duration of 1 minute
Operating temperature:	-40 °C to +85 °C
Operating force:	N: 1.6 N ± 0.5 N
	R: 2.6 N ± 0.5 N
Mechanical life:	minimum 1 000 000 operations
Material:	Contacts: stainless steel, silver-plated
	Terminals: brass, silver plated
	Cover: stainless steel
	Base: LCP, UL 94 V-0, black, washable
	Stem: PA, UL 94 V-0
Protection:	IP 67
Mounting:	on pc-board – SMD

3

Models:

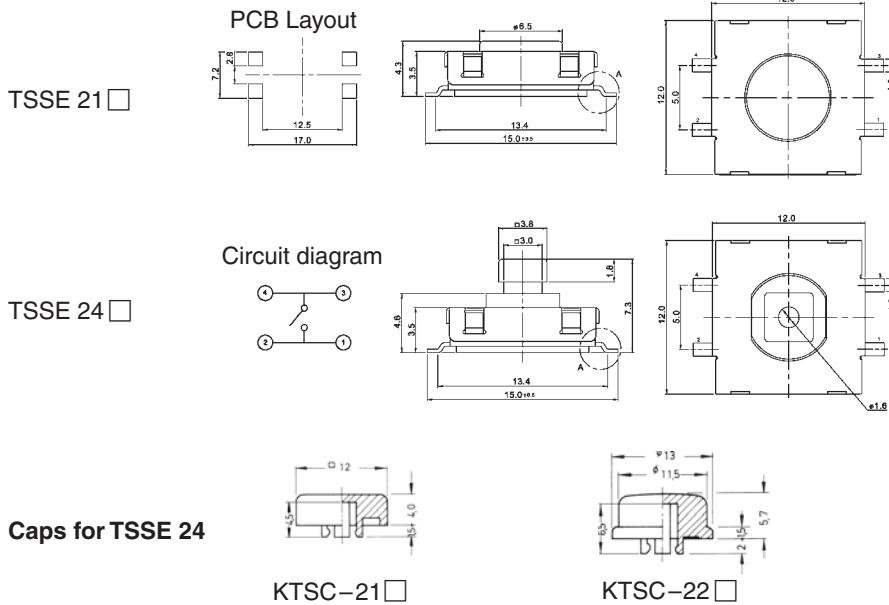

washable

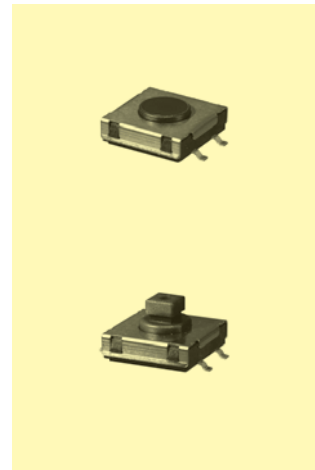

Ordering code:

Switches **TSSE 2** □ □

Dimension / Packing:

1 4,3 mm / 700 pcs/reel

4 7,3 mm / 500 pcs/reel

Colour of stem for operating force:

1 1,6 N, brown

2 2,6 N, red

Caps **KTSC-2** □ □

Cap type:

1 square

2 round

Cap colour:

1 yellow

2 blue

3 red

4 ivory

5 black

6 green



Tact Switches waterproof

Specifications:

Contact rating:	50 V DC, 50 mA
Contact resistance:	<100 mΩ
Insulation resistance:	>1000 MΩ
Dielectric strength:	250 V, 50 Hz for the duration of 1 minute
Operating temperature:	-40 °C to +85 °C
Operating force:	N: 1.6 N ± 0.5 N R: 2.6 N ± 0.5 N
Mechanical life:	minimum 1 000 000 operations
Material:	Contacts: stainless steel, silver-plated Terminals: brass, silver plated Cover: stainless steel Base: LCP, UL 94 V-0, black, washable Stem: PA, UL 94 V-0
Mounting:	on pc-board
Protection:	IP 67
Soldering conditions:	wave soldering, max. 5 s max. 260 °C, pre-heat max. 60 s max. 100 °C
Travel:	0.35 mm ± 0.15 mm

Models:

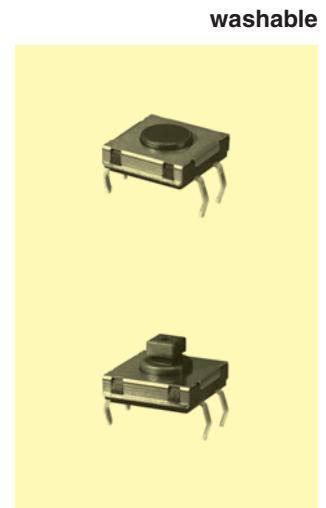
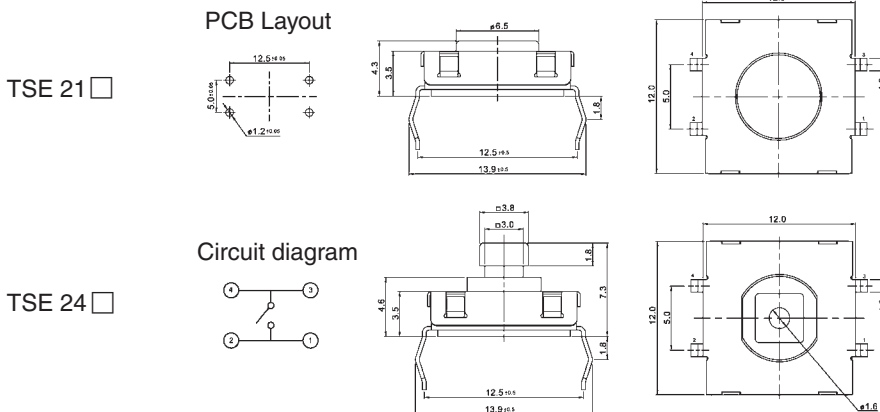

Caps for TSE 24



Ordering code:

Switches TSE 2

Dimension:
 4,3 mm
 7,3 mm

Colour of stem for operating force:
 1,6 N, brown
 2,6 N, red

Caps KTSC-2

Cap type:
 square
 round

Cap colour:
 yellow
 blue
 red
 ivory
 black
 green

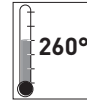

Specifications:

Contact rating:	12 V DC, 50 mA
Contact resistance:	< 100 mΩ
Insulation resistance:	> 100 MΩ at 500 V DC
Dielectric strength:	250 V, 50 Hz for the duration of 1 minute
Operating temperature:	- 40 °C to + 85 °C
Electrical life:	1,0 N/1,6 N: minimum 200 000 cycles 2,6 N: minimum 100 000 cycles 3,2 N/5,2 N: minimum 50 000 cycles
Operating force:	see ordering code
Contacts:	phosphor bronze, silver-plated
Terminals:	brass, silver-plated
Material:	cover: stainless steel base and stem: nylon meets UL 94 V-0; caps ABS
Mounting:	on pc-board – SMD
Soldering conditions:	hand-soldering – max.: 30 W, 2 sec, 320 °C
Travel:	0,25 mm + 0,2/- 0,1 mm

Models:

TSS 6

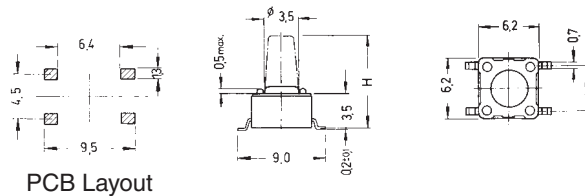

TSS 644

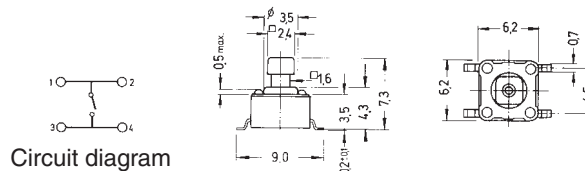

Caps for TSS 644

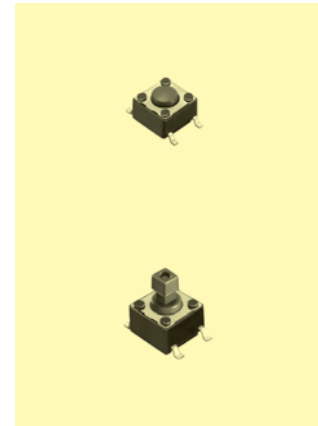

Ordering code:

Switches

TSS 6

Dimension H / Packing:

- 1 4,3 mm / 1000 pcs / reel
- 2 5,0 mm / 900 pcs / reel
- 3 7,0 mm / 700 pcs / reel
- 4 7,3 mm / 700 pcs / reel*
- 5 9,5 mm / 380 pcs / reel
- 6 11,0 mm / 77 pcs / reel
- 7 13,0 mm / 77 pcs / tube
200 pcs / reel

Colour of stem
for operating force:

- K 1,0 N, black
- N 1,6 N, brown
- R 2,6 N, red
- S 3,2 N, salmon
- Y 5,2 N, yellow

Caps KTSC-6

Cap type:

- 1 square
- 2 round

Cap colour:

- Y yellow
- B blue
- R red
- I ivory
- K black
- G green

* only with square stem



Tact Switches

Specifications:

Contact rating:	12 V DC, 50 mA
Contact resistance:	< 100 mΩ
Insulation resistance:	> 100 MΩ at 500 V DC
Dielectric strength:	250 V, 50 Hz for the duration of 1 minute
Operating temperature:	- 40 °C to + 85 °C
Electrical life:	1,0 N/1,6 N: minimum 200 000 cycles 2,6 N: minimum 100 000 cycles 3,2 N/5,2 N: minimum 50 000 cycles
Operating force:	see ordering code
Contacts:	phosphor bronze, silver-plated
Terminals:	PC terminals, brass, silver-plated
Material:	cover: stainless steel base and stem: nylon meets UL 94 V-0; caps ABS
Mounting:	on pc-board
Soldering conditions:	hand-soldering – max.: 30 W, 2 sec, 320 °C auto-soldering – max.: 5 sec, 260 °C subject to PCB 1,6 mm thickness
Travel:	0,25 mm + 0,2/- 0,1 mm

Models:

TS 6

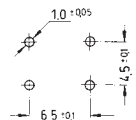

PCB Layout

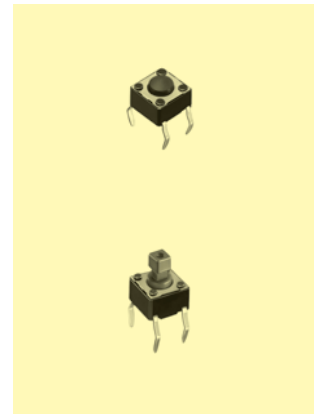
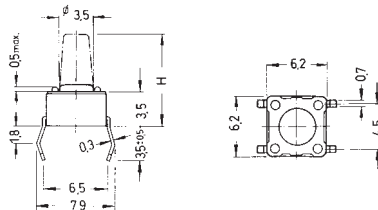

TS 644



Circuit diagram

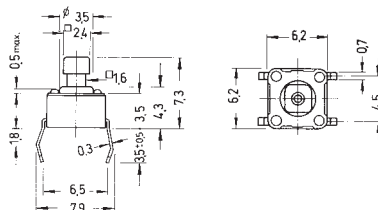

Caps for TS 644

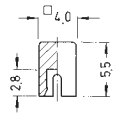

KTSC-61

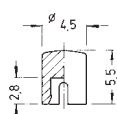

KTSC-62

Ordering code:

Switches TS 6

Dimension H

- 1 4,3 mm
- 2 5,0 mm
- 3 7,0 mm
- 4 7,3 mm*
- 5 9,5 mm
- 6 13,0 mm

Colour of stem for operating force:

- K 1,0 N, black
- N 1,6 N, brown
- R 2,6 N, red
- S 3,2 N, salmon
- Y 5,2 N, yellow

Caps KTSC-6

Cap type:

- 1 square
- 2 round

Cap colour:

- Y yellow
- B blue
- R red
- I ivory
- K black
- G green

* only with square stem

Tact Switches

Specifications:

Contact rating:	12 V DC, 50 mA
Contact resistance:	< 100 mΩ
Insulation resistance:	> 100 MΩ at 500 V DC
Dielectric strength:	250 V, 50 Hz for the duration of 1 minute
Operating temperature:	- 40 °C to + 85 °C
Electrical life:	1,0 N/1,6 N: minimum 200 000 cycles 2,6 N: minimum 100 000 cycles 3,2 N/5,2 N: minimum 50 000 cycles
Operating force:	see ordering code
Contacts:	phosphor bronze, silver-plated
Terminals:	PC terminals, brass, silver-plated
Material:	cover: steel, tin-plated base and stem: nylon meets UL 94 V-0; caps ABS
Mounting:	on pc-board
Soldering conditions:	hand-soldering – max.: 30 W, 2 sec, 320 °C auto-soldering – max.: 5 sec, 260 °C subject to PCB 1,6 mm thickness
Travel:	0,25 mm + 0,2/- 0,1 mm

Models:

TS 6□□-RA

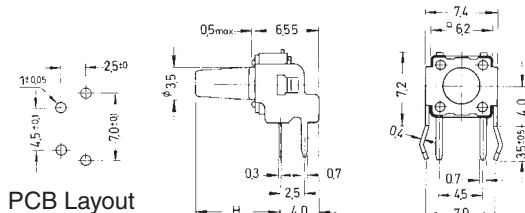

TS 644□-RA

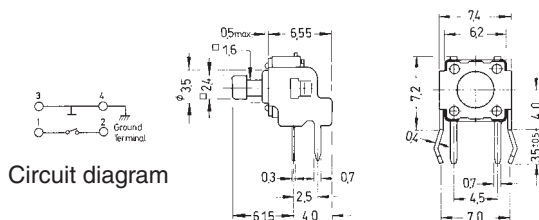

Caps for TS 644 □-RA



Ordering code:

Switches TS 6□ □-RA

Dimension H

- 1 3,15 mm
- 2 3,85 mm
- 3 5,85 mm
- 4 6,15 mm*
- 5 8,35 mm
- 6 11,85 mm

Colour of stem for operating force:

- K 1,0 N, black
- N 1,6 N, brown
- R 2,6 N, red
- S 3,2 N salmon
- Y 5,2 N, yellow

* only with square stem

Caps KTSC-6□ □

Cap type:

- 1 square
- 2 round

Cap colour:

- Y yellow
- B blue
- R red
- I ivory
- K black
- G green

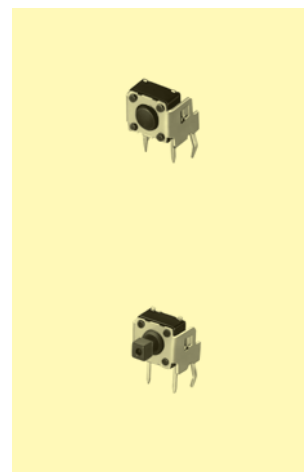

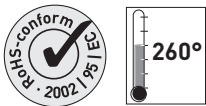

Tact Switches for SMT

Specifications:

Contact rating:	24 V DC, 100 mA max.
Contact resistance:	< 100 mΩ
Insulation resistance:	> 100 MΩ at 500 V DC
Dielectric strength:	250 V AC, 50 Hz for the duration of 1 minute
Operating temperature:	- 55 °C to + 125 °C
Electrical life:	minimum 100 000 cycles
Operating force:	3,0 ± 1,0 N
Contacts/terminals:	gold-plated/silver-plated
Material:	cover: stainless steel, base: high-temp. nylon meets UL 94 V-0, stem: silicone rubber
Mounting:	on pc-board – SMD
Soldering conditions:	max.: 5 sec, 260 °C
Travel:	max. 1,27 mm

3

Models:

Switching functions:

washable

TMSE 10

off – mom

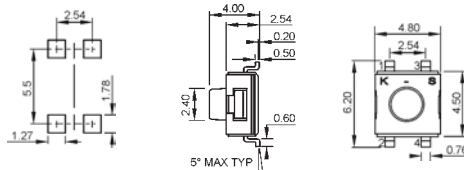

TMSE 10 J

off – mom

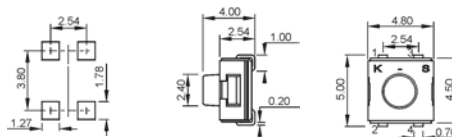

TMSE 10 J-RA

off – mom

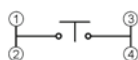
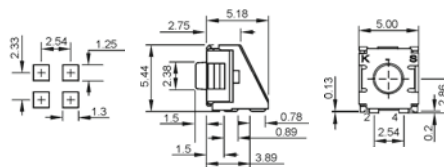

Packing:

TMSE 10:	500 pcs/reel
TMSE 10 J:	500 pcs/reel
TMSE 10 J-RA:	200 pcs/reel

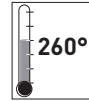

Specifications:

Contact rating:	12 V DC, 50 mA / 1 V DC, 0.5 mA
Contact resistance:	< 100 mΩ
Insulation resistance:	> 2 GΩ at 100 V DC
Dielectric strength:	250 V, 50 Hz for the duration of 1 minute
Operating temperature:	-40 °C to +85 °C
Electrical life:	minimum 250 000 cycles
Operating force:	2.16 N ± 0.59 N
Contacts:	metal contact, stainless steel, silver-plated
Terminals:	phosphor bronze, silver-plated
Material:	case: PA9T button: PA9T frame: phosphor bronze, tin-plated
Mounting:	on pc-board – SMD
Travel:	0.15 mm ± 0,05 mm

3

Model:

TSS 4-RA

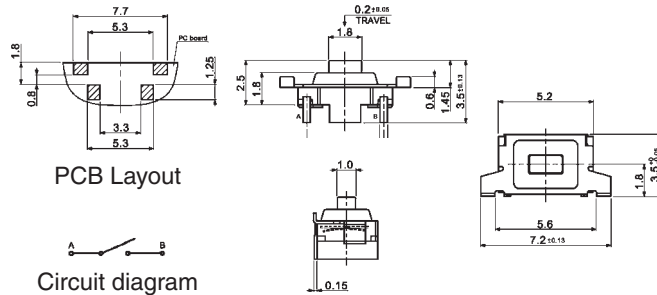

Packing: 2000 pcs/reel

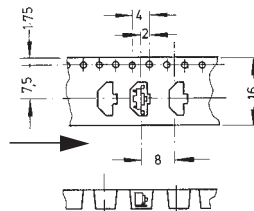

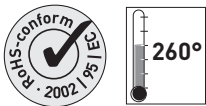

Tact Switches

Specifications:

Contact rating:	12 V DC, 50 mA
Contact resistance:	< 100 mΩ
Insulation resistance:	> 100 MΩ at 500 V DC
Dielectric strength:	250 V, 50 Hz for the duration of 1 minute
Operating temperature:	-25 °C to +70 °C
Electrical life:	1.6 N / 3.2 N: minimum 50 000 cycles 2.6 N / 5.2 N: minimum 30 000 cycles
Operating force:	see ordering code
Contacts:	stainless steel, silver-plated
Terminals:	brass, silver-plated
Material:	cover: stainless steel base and stem: high-temp. nylon meets UL 94 V-0 or PPA
Mounting:	TS 3: on PC-board TSS 3: on PC-board – SMD
Soldering conditions:	TS 3: hand-soldering – max.: 30 W, 2 sec, 320 °C auto-soldering – max.: 5 sec, 260 °C subject to PCB 1.6 mm thickness TSS 3: reflow-soldering, see page 5
Travel:	0.25 mm + 0.2/- 0.1 mm

Models:

TS 3 □ □

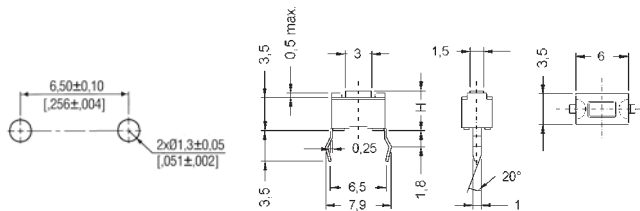

TSS 3 □ □

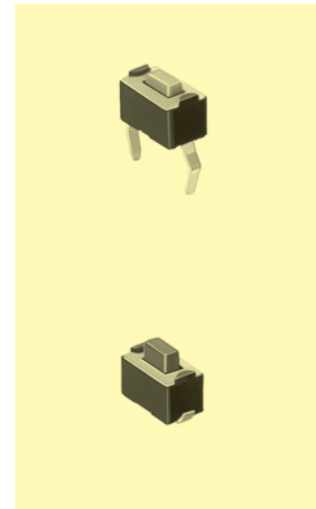
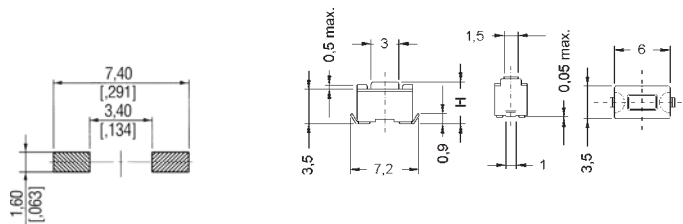

Ordering Code: TS 3 / TSS 3 □ □

Dimension H

- ① 4,3 mm
- ② 5,0 mm

Colour of stem
for operating force:

- Ⓝ brown, 1,6 N
- Ⓡ red, 2,6 N
- Ⓢ salmon, 3,2 N
- Ⓨ yellow, 5,2 N

Packing:	TS 3	in tubes, 135 pieces / tube
	TSS 31	on tape, 1800 pieces / reel
	TSS 32	on tape, 1600 pieces / reel

Tact Switches for SMT

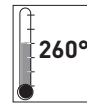

Specification:

Contact rating:	12 V DC, 50 mA
Contact resistance:	< 500 mΩ
Insulation resistance:	> 10 MΩ
Dielectric strength:	100 V, 50 Hz for the duration of 1 minute
Operating temperature:	- 40 °C to + 85 °C
Operating force:	N: 1.8 N ± 0.5 N S: 3.5 N ± 0.9 N
Mechanical life:	minimum 1 000 000 operations
Material:	Contacts: stainless steel, silver-plated Terminals: phosphor-bronze, silver plated Case: PA46, black Actuator: TSS 309: PA46, blue, TSSE 310: silicone rubber, black
Protection:	TSSE 310: IP 67
Mounting:	on pc-board
Packaging:	2500 pcs/reel

Models:

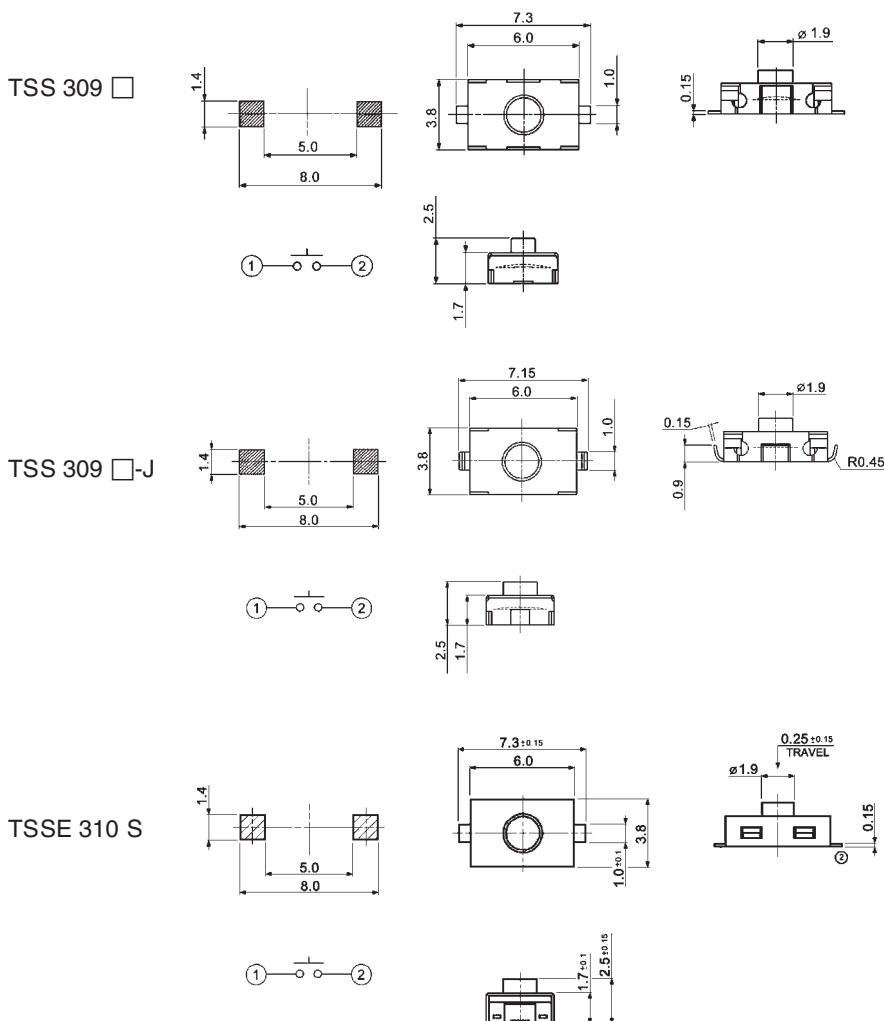

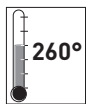

Tact Switches for SMT

Specification:

Contact rating:	12 V DC, 50 mA
Contact resistance:	< 500 mΩ
Insulation resistance:	> 100 MΩ
Dielectric strength:	250 V, 50–60 Hz for the duration of 1 minute
Operating temperature:	– 10 °C to + 60 °C
Operating force:	2,5 N ± 0,7 N
Mechanical life:	100 000 cycles
Contacts:	silver-plated
Mounting:	on pc-board – SMD
Travel:	0,25 mm ± 0,1 mm
Packing:	4000 pcs/reel

3

Model:

TSS 507

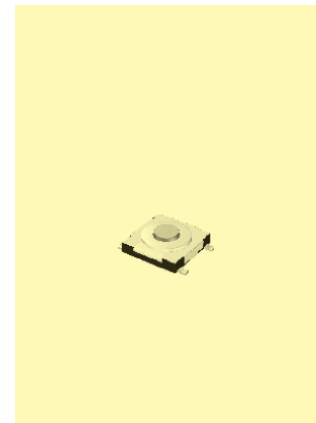
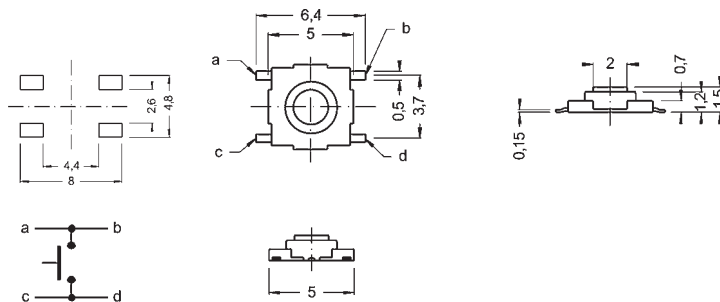

Tact Switches

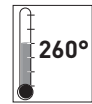

Specification:

Contact rating:	12 V DC, 50 mA
Contact resistance:	< 500 mΩ
Insulation resistance:	> 100 MΩ
Dielectric strength:	250 V, 50–60 Hz for the duration of 1 minute
Operating temperature:	– 20 °C to + 70 °C
Mechanical life:	minimum 50 000 cycles
Contacts:	silver-plated
Mounting:	on pc-board, TSS 313 RA = on pc-board – SMD
Packing unit:	TS 637 RA: 500 pieces/bag TSS 313 RA: 2000 pieces/bag

Models:

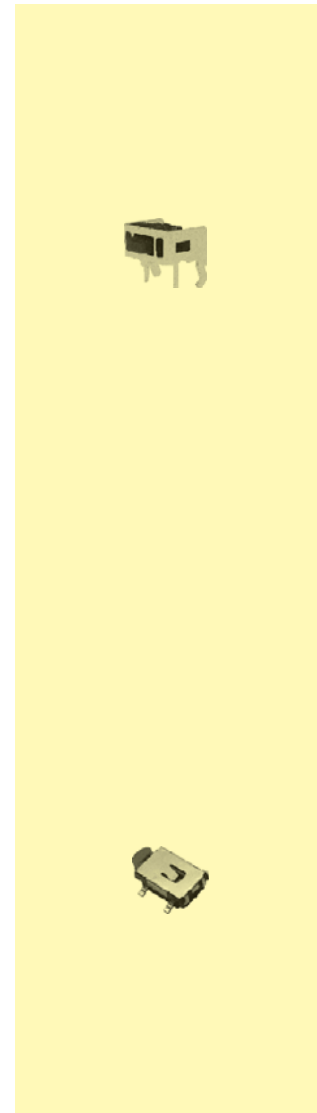
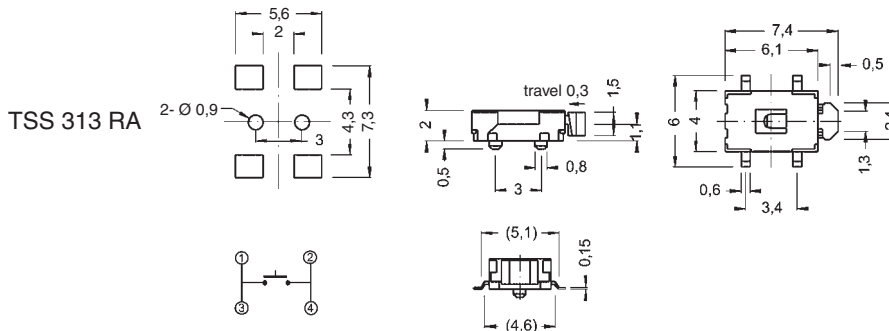
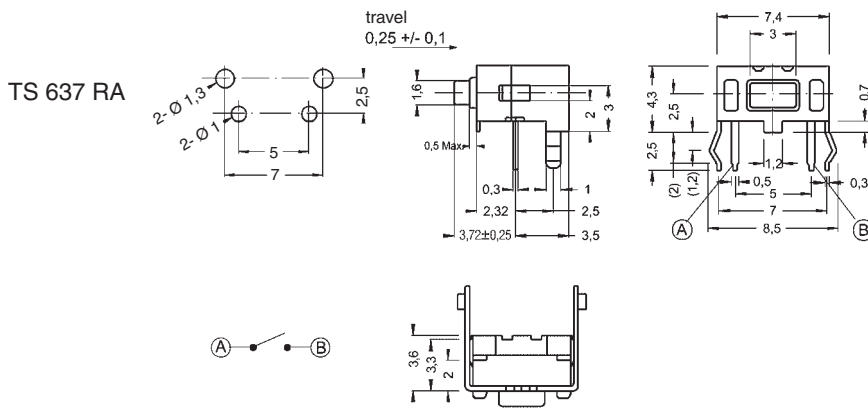

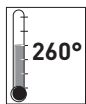

Long Travel Tact switch for SMT

Specifications:

Contact rating:	12 V DC, 50 mA,
Contact resistance:	< 100 mΩ
Insulation resistance:	> 100 MΩ
Dielectric strength:	300 V, 50 Hz for the duration of 1 minute
Operating temperature:	- 40 °C to + 85 °C
Mechanical life:	minimum 100 000 cycles
Operating force:	R: 200 gf ± 50 gf S: 350 gf ± 100 gf
Contacts:	gold-plated
Terminals:	silver-plated
Travel:	1,3 mm + 0,1/- 0,3 mm
Material:	case and actuator: Nylon meets UL 94V-0
Mounting:	on pc-board – SMD
Travel:	1,3 mm + 0,1/- 0,3 mm
Packing:	900 pieces/reel

3

Models:

TSS 650 □-J

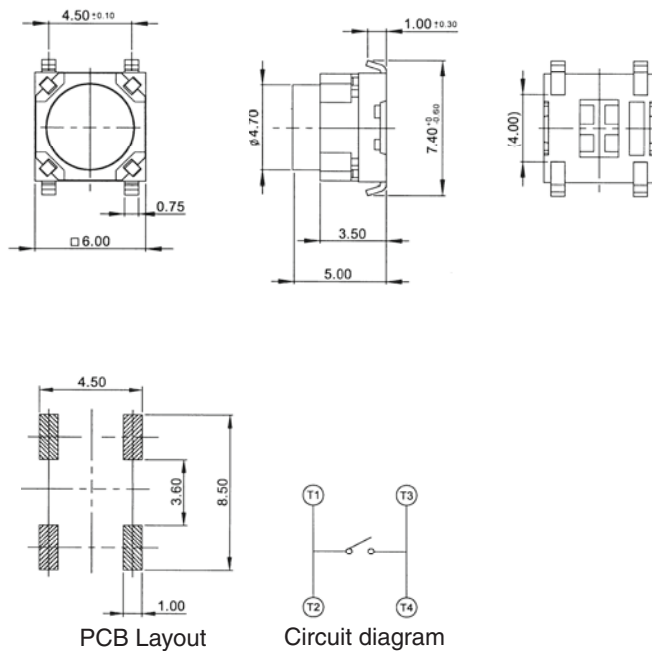

Ordering code: TSS 650 □-J

Operating force: R 2,0 N
 S 3,5 N

Multi-Function Tact Switches for SMT



Specification:

Contact rating:	5 V DC, 10 mA
Contact resistance:	< 500 mΩ
Insulation resistance:	> 100 MΩ
Dielectric strength:	100 V, 50 Hz for the duration of 1 minute
Operating temperature:	- 10 °C to + 70 °C
Storage temperature:	- 25 °C to + 85 °C
Mechanical life:	minimum 100 000 cycles
Contacts:	phosphor bronze silver-plated
Mounting:	on pc-board – SMD
Soldering conditions:	reflow-soldering – max.: 240 °C ± 5 °C, 10 sec max.

3

Models:

PLSJ 1

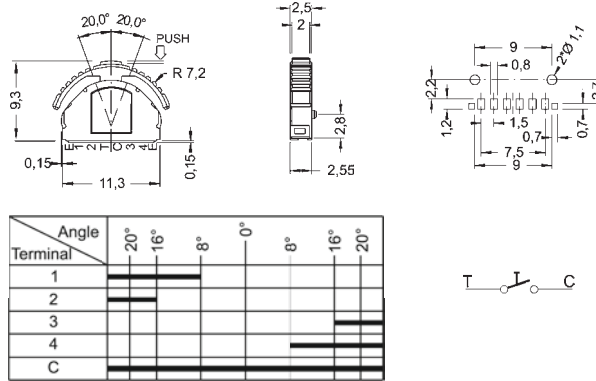

Packing unit: 1000 pieces per reel

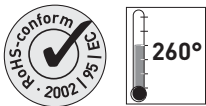

Multi-Function Tact Switches for SMT

Specifications:

Contact rating:	12 V DC, 50 mA
Contact resistance:	< 100 mΩ
Insulation resistance:	> 100 MΩ
Dielectric strength:	250 V AC (50 Hz or 60 Hz) for 1 minute
Operating temperature:	- 20 °C to + 70 °C
Operating force:	4 directions: 1,6 ± 0,5 N
Mechanical life:	minimum 100 000 cycles
Material:	Cover: Nickel, silver-plated Stem: high-temp. LCP Contact: stainless steel with silver cladding Terminal: brass, silver-plated Base: high-temp. LCP, black
Packing:	850 pcs/reel

3

Models:

TSSJ 4

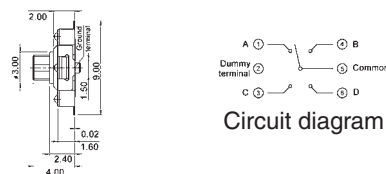
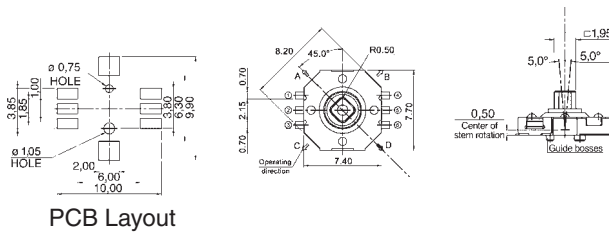

TSSJ 4-J

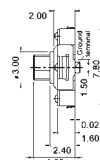
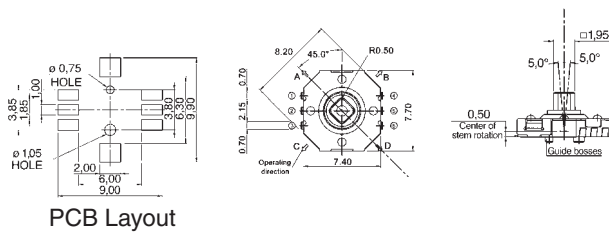

Miniature Tact Switches for SMT

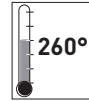

Specifications:

Contact rating:	12 V DC, 50 mA
Contact resistance:	< 100 mΩ
Insulation resistance:	> 100 MΩ
Dielectric strength:	250 V AC (50 Hz or 60 Hz) for 1 minute
Operating temperature:	- 20 °C to + 70 °C
Operating force:	center: 3,2 N ± 0,5 N; 4 directions: 1,6 N ± 0,5 N
Mechanical life:	minimum 100 000 cycles
Material:	Cover: Nickel, silver-plated Stem: high-temp. LCP Contact: stainless steel with silver cladding Terminal: brass, silver-plated Base: high-temp. LCP, black
Packing:	850 pcs/reel

Models:

TSSJ 5

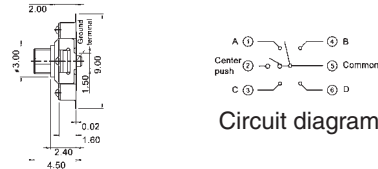
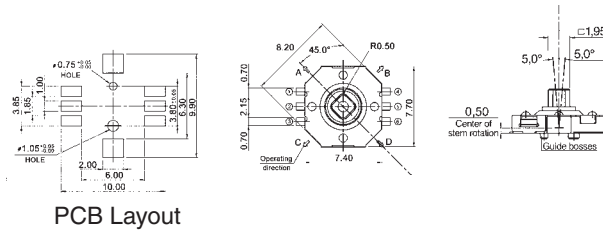

TSSJ 5-J

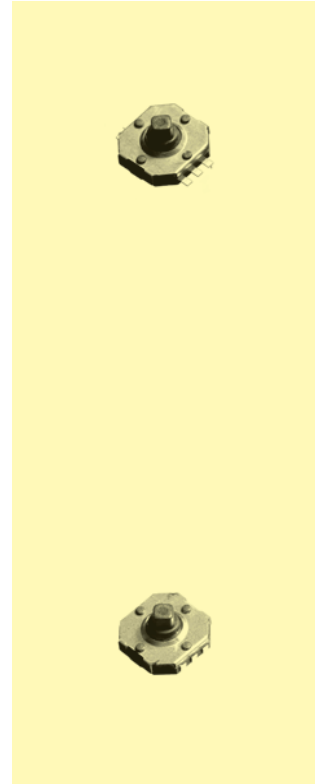
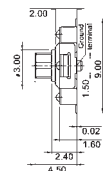
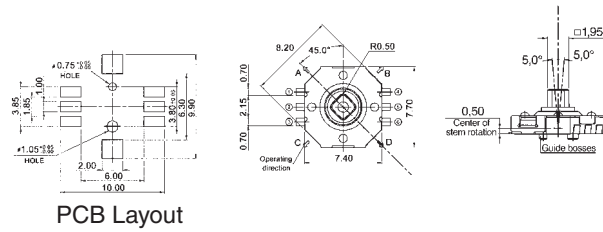



Multi-Function Tact Switches

Specification:

Contact rating:	15 V DC, 20 mA
Contact resistance:	< 100 mΩ
Insulation resistance:	> 100 MΩ
Dielectric strength:	100 V, 50 Hz for the duration of 1 minute
Operating temperature:	- 25 °C to + 70 °C
Mechanical life:	minimum 50 000 cycles per direction
Contacts:	phosphor bronze silver-plated
Mounting:	TSJ 31: on pc-board TSSJ 30: on pc-board – SMD
Soldering conditions:	TSJ 31: auto-soldering: 255 °C, 5 sec max. TSSJ 30: reflow-soldering: 245 °C, 2,5 sec max.
Packing:	300 pcs/tray

3

Models:

TSJ 31

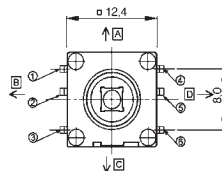
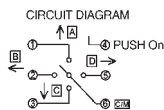
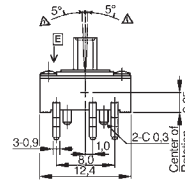
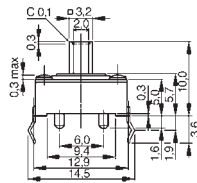
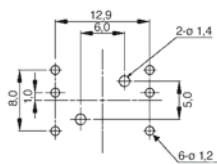

Direction	Connection
A	1 - 6
B	2 - 6
C	3 - 6
D	5 - 6
E (push)	4 - 6

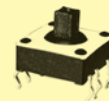

TSSJ 30

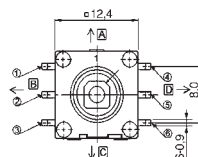
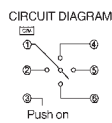
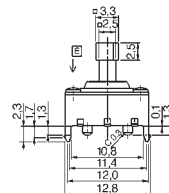
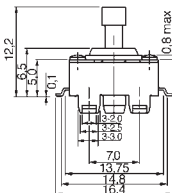
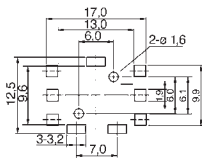

Direction	Connection
A	1 = 4
B	1 = 2
C	1 = 6
D	1 = 5
E (push)	1 = 3



4 Slide Switches

4.1 Professional Slide Switches



Series ASE / ASL		102–103
Series MFP / MFS		104–105
Series MSS	low cost	106–107
Series MFP / MFS	low cost	108–119

4.2 Microminiature Slide Switches



Series MMP / MMS / MMSP		120–127
-------------------------	--	---------

Subminiature Slide Switches



Specifications:

Contact rating:	max. 48 V AC/DC, 0,4 VA / max. 50 mA min. 20 mV AC/DC, 1 μ A
Contact resistance:	< 50 m Ω
Insulation resistance:	> 500 M Ω at 250 V DC
Dielectric strength:	500 V, 50 Hz for the duration of 1 minute
Operating temperature:	- 20 °C to + 80 °C
Mechanical life:	minimum 50 000 operations
Contacts:	phosphor bronze, gold-plated over nickel barrier
Terminals:	PC terminals, crimped, phosphor bronze, gold-plated over nickel barrier
Material:	case: PBT, meets UL 94 V-0, washable metal parts: nickel-plated brass
Mounting:	on pc-board
Soldering conditions:	auto-soldering – max.: 5 sec \pm 1 sec., 260 °C \pm 5 °C

4

One pole switches with flat terminals have a limited stability against side force.
The stability can be improved by using a supporting bracket.

Special pin configuration:

Subminiature slide switch
with 5,08 mm spacing

Additional to type number: -1

Example of order: ASE 2D – RA – 1

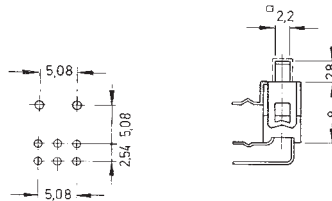



Subminiature Slide Switches

Models: Switching function – the closed contacts correspond to the slide position

SPDT

ASE 1 D

on – on

ASE 1 E

on off on

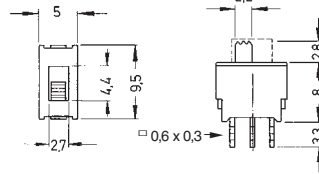
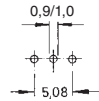

DPDT

ASE 2 D

on – on

ASE 2 E

on off on

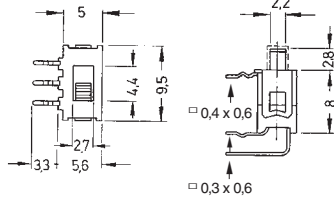
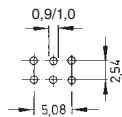

SPDT

ASE 1 D – RA

on – on

ASE 1 E – RA

on off on

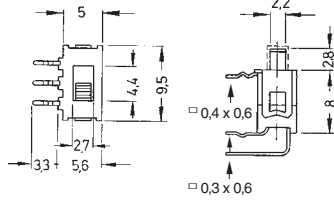
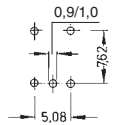

DPDT

ASE 2 D – RA

on – on

ASE 2 E – RA

on off on

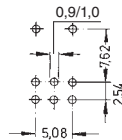

washable

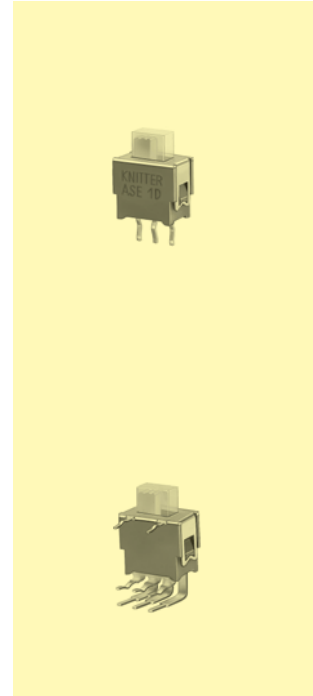

The cap can be removed after washing.

Models: Switching function – the closed contacts correspond to the slide position

SPDT

ASL 1 D

on – on

ASL 1 E

on off on

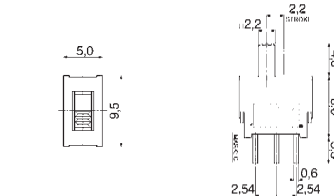

DPDT

ASL 2 D

on – on

ASL 2 E

on off on

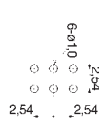

SPDT

ASL 1 D – RA

on – on

ASL 1 E – RA

on off on

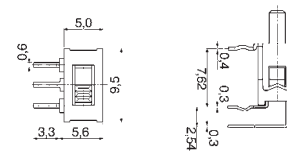
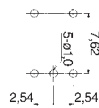

DPDT

ASL 2 D – RA

on – on

ASL 2 E – RA

on off on

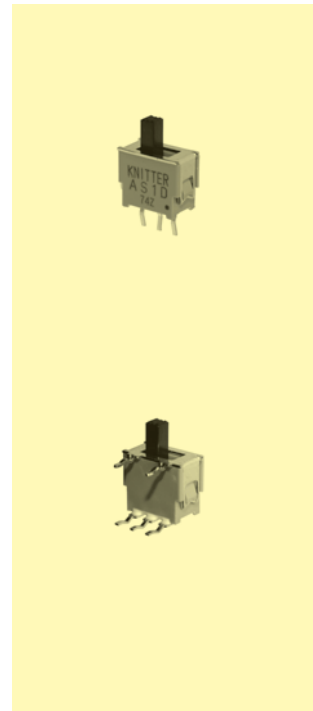

4

Miniature Slide Switches

Specifications:

Contact rating:	250 V AC, 3 A / 125 V AC, 6 A / 30 V DC, 4 A
Contact resistance:	< 20 mΩ
Insulation resistance:	> 1000 MΩ at 500 V DC
Dielectric strength:	1500 V, 50 Hz for the duration of 1 minute
Operating temperature:	- 10 °C to + 60 °C
Mechanical life:	minimum 20 000 operations
Contacts:	coin silver (common contact copper alloy, silver-plated) also available: gold-plated, version G (see page 4)
Terminals:	MFP PC terminals; MFS solder tags
Case material:	PBT, with glass fibre
Slide colour:	black
Soldering conditions:	auto-soldering – max.: 5 sec, 260 °C ± 5 °C hand-soldering – max.: 5 sec, 300 °C

4

Models: Switching functions

SPDT
MFP 106 D on – on

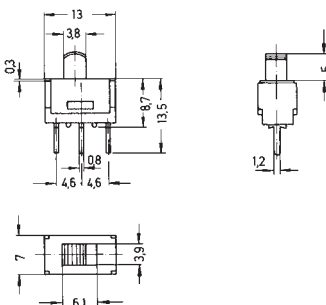

SPDT
MFS 106 D on – on

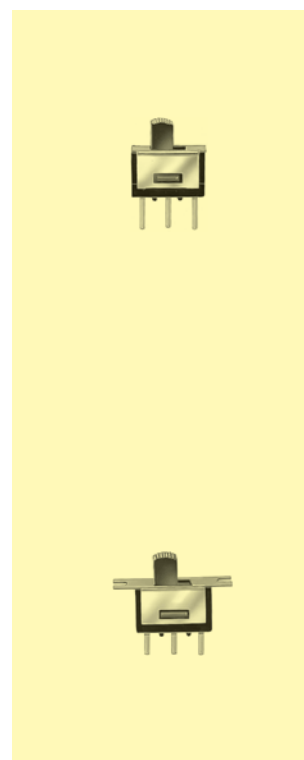
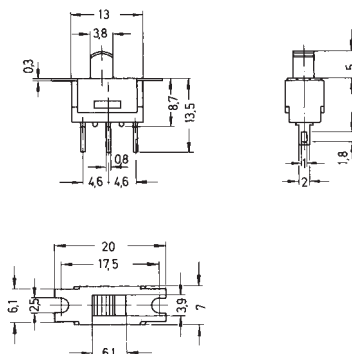



Miniature Slide Switches

Specifications:

Contact rating:	20 V AC or DC, 0,4 VA
Contact resistance:	< 10 mΩ
Insulation resistance:	> 1000 MΩ
Dielectric strength:	1000 V, 50 Hz for the duration of 1 minute
Operating temperature:	- 30 °C to + 85 °C
Mechanical life:	minimum 30 000 operations
Contacts/ Terminals:	PC terminals or solder tags, brass gold-plated
Material:	case: PA, slide: PA
Soldering conditions:	auto-soldering – max.: 5 sec, 260 °C ± 5 °C hand-soldering – max.: 5 sec, 300 °C

Models: Switching functions

S P D T

MFP 126 DB – PC on – on

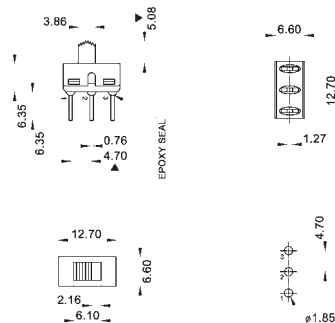

S P D T

MFP 126 DB – RA on – on

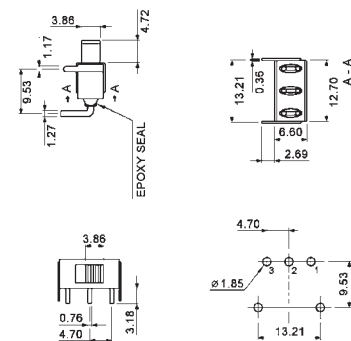

S P D T

MFS 126 DB on – on

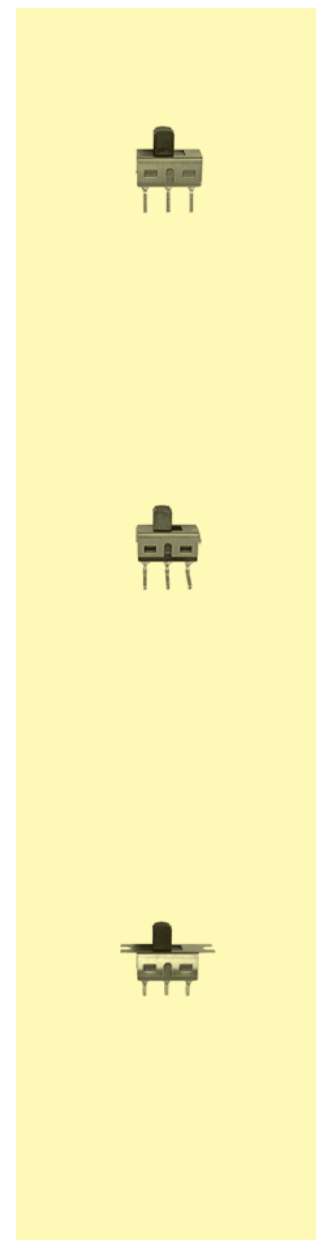
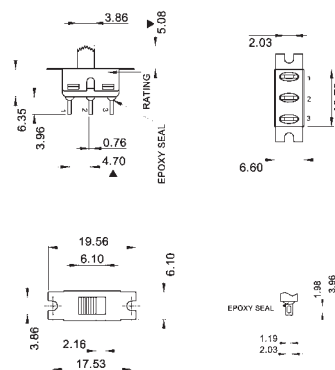

Miniature Slide Switches

Specifications:

Contact rating:	125 V AC, 100 mA / 60 V DC, 100 mA
Contact resistance:	< 10 mΩ
Insulation resistance:	> 1000 MΩ, at 500 V DC
Dielectric strength:	1000 V, 50 Hz for the duration of 1 minute
Mechanical life:	minimum 30 000 operations
Operating temperature:	- 45 °C to + 85 °C
Contacts/Terminals:	PC terminals, copper alloy with 2 μ gold-plating over 3 μ nickel barrier
Material:	case: diallyl-phthalate, cover and slide: Noryl SE 0
Mounting:	on pc-board
Soldering conditions:	auto-soldering – max.: 5 sec, 260 °C ± 5 °C hand-soldering – max.: 20 W, 5 sec, 270 °C

4

Models: Switching functions

SPDT
MSS 101 DB on – on

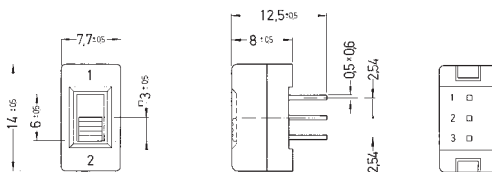

SPDT
MSS 111 DB on – on

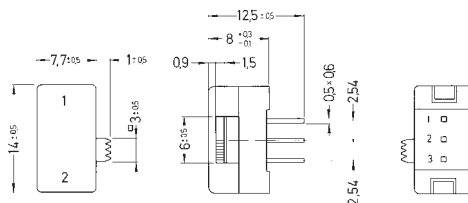

DPDT
MSS 201 NB on – on

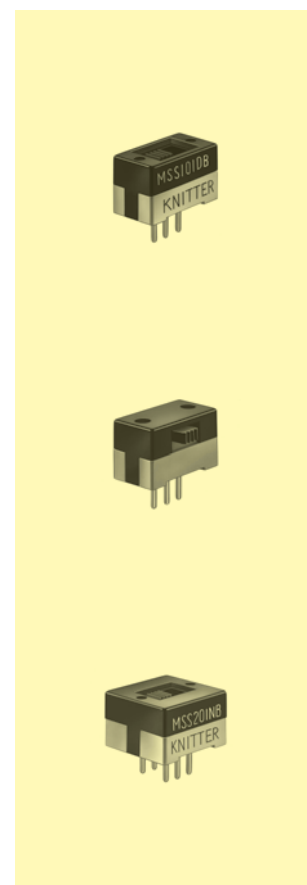
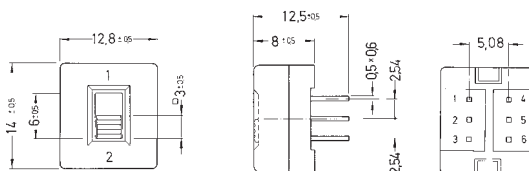



Miniature Slide Switches

Specifications:

Contact rating:	250 V AC, 1 A / 120 V AC or 28 V DC, 3 A
Contact resistance:	< 100 mΩ
Insulation resistance:	> 1000 MΩ
Dielectric strength:	1000 V, 50 Hz for the duration of 1 minute
Operating temperature:	-40 °C to +85 °C
Mechanical life:	minimum 20 000 operations
Material:	Actuator: nylon, black Case: nylon, black Base: nylon, white
Contacts/Terminals:	copper alloy, silver-plating
Soldering conditions:	auto-soldering – max.: 5 sec, 260 °C ± 5 °C

Models: Switching functions

MSS 3011 D on – on

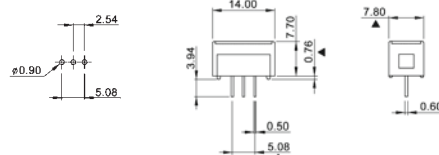

MSS 3112 D on – on

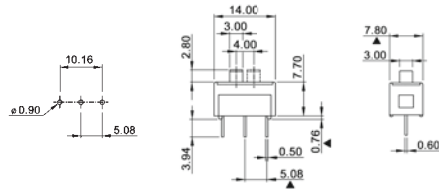

MSS 3121 N-R on – on

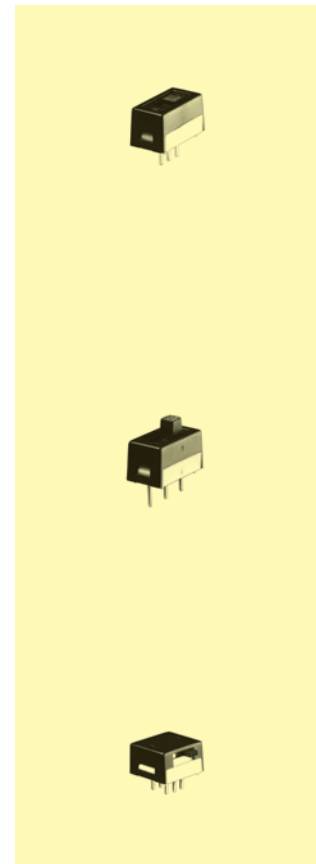
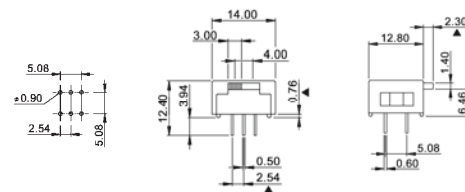

Ordering code:

MSS 3

Actuator:

- Recessed
- Raised

Terminal spacing:

- 2,54 mm
- 5,08 mm

Number of Poles:

- Single pole
- Double pole

Switching function:

- SP, ON – ON
- DP, ON – ON

- Top actuated
- Side actuated

Miniature Slide Switches

Specifications:

Contact rating:	30 V DC, 350 mA
Contact resistance:	< 20 mΩ
Insulation resistance:	> 100 MΩ at 500 V DC
Dielectric strength:	500 V, 50 Hz for the duration of 1 minute
Operating temperature:	- 20 °C to + 85 °C
Mechanical life:	minimum 10 000 operations
Contacts:	copper alloy, silver-plated over nickel barrier
Contact timing:	non-shorting
Slide colour:	black, further colours on request
Soldering conditions:	auto-soldering – max.: 3 sec, 260 °C ± 5 °C

Models:	Operating positions	Length (mm)	
		A	B

MFP 120	2	11,0	6,6
MFP 130	3	15,0	10,0
MFP 140	4	18,2	13,2
MFP 150	5	21,4	16,4

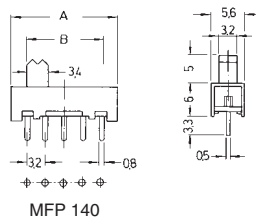

MFP 120 – R	2	11,0	6,6
MFP 130 – R	3	15,0	10,0
MFP 140 – R	4	18,2	13,2
MFP 150 – R	5	21,4	16,4

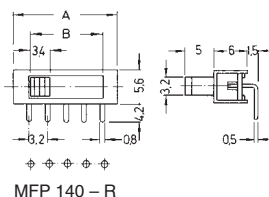

MFP 220	2	13,6	6,9
MFP 230	3	16,8	10,1
MFP 240	4	20,0	13,3
MFP 250	5	23,2	16,5
MFP 260	6	26,4	19,7

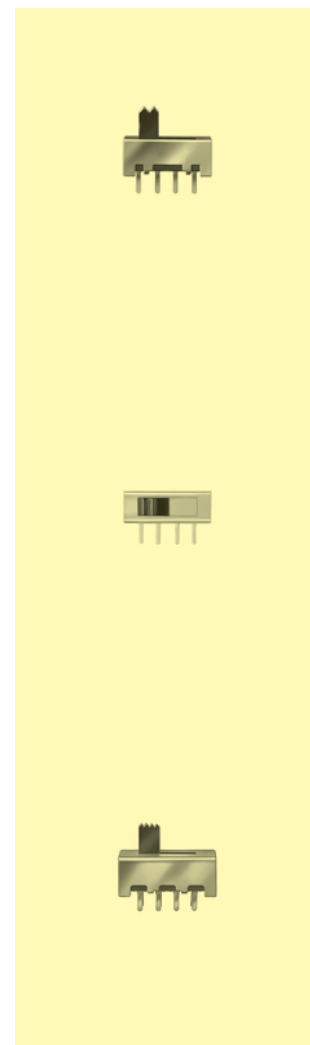
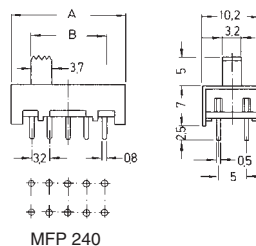
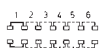



Miniature Slide Switches

Specifications:

Contact rating:	30 V DC, 350 mA
Contact resistance:	< 25 mΩ
Insulation resistance:	> 100 MΩ at 500 V DC
Dielectric strength:	500 V, 50 Hz for the duration of 1 minute
Operating temperature:	- 20 °C to + 85 °C
Mechanical life:	minimum 10 000 operations
Contacts:	copper alloy, silver-plated over nickel barrier
Contact timing:	non-shorting
Slide colour:	black, further colours on request
Soldering conditions:	auto-soldering – max.: 10 sec, 260 °C

4

Models:	Operating positions	Length (mm)	
		A	B

MFP 1370	3		20,0	7,6
MFP 1470	4		20,0	9,9
MFP 1570	5		22,0	12,2

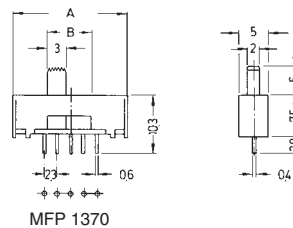

MFP 1370 – R	3		20,0	7,6
MFP 1470 – R	4		20,0	9,9
MFP 1570 – R	5		22,0	12,2

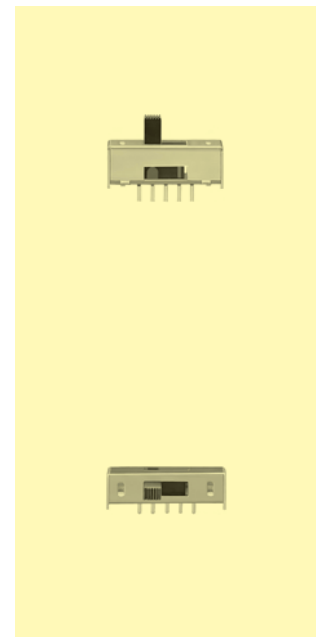
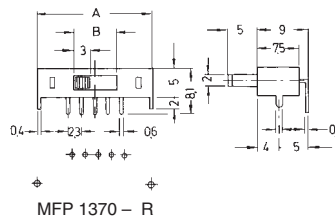

Miniature Slide Switches

Specifications:

Contact rating:	30 V DC, 350 mA
Contact resistance:	< 20 mΩ
Insulation resistance:	> 100 MΩ at 500 V DC
Dielectric strength:	500 V, 50 Hz for the duration of 1 minute
Operating temperature:	- 20 °C to + 85 °C
Mechanical life:	minimum 10 000 operations
Contacts:	copper alloy, silver-plated over nickel barrier
Contact timing:	shorting (non-shorting only if specified)
Slide colour:	black, further colours on request
Soldering conditions:	auto-soldering – max.: 5 sec, 260 °C ± 5 °C

Models:	Operating positions	Length (mm)	
		A	B

MFP 1220	2	13,0	7,5
MFP 1320	3	15,5	10,0
MFP 1420	4	18,0	12,5
MFP 1520	5	20,5	15,0
MFP 1620	6	23,0	17,5

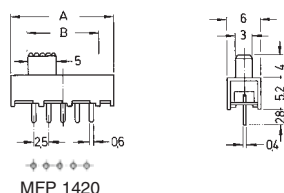

MFP 1220 – R	2	13,0	7,5
MFP 1320 – R	3	15,5	10,0
MFP 1420 – R	4	18,0	12,5
MFP 1520 – R	5	20,5	15,0
MFP 1620 – R	6	23,0	17,5

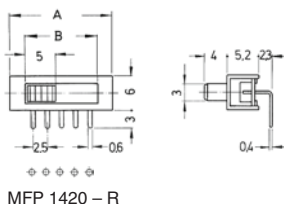
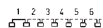

MFP 1323	3	15,5	10,0
MFP 1424	4	18,0	12,5

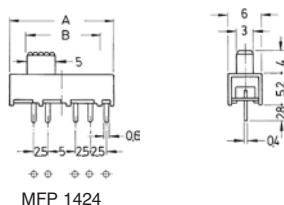
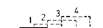

MFP 1323 – R	3	15,5	10,0
MFP 1424 – R	4	18,0	12,5

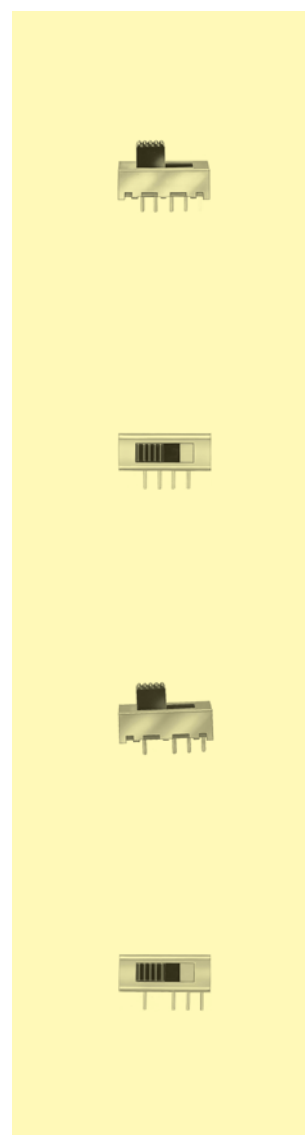
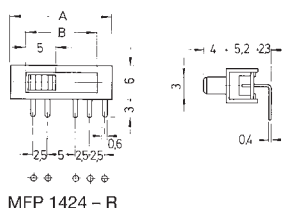
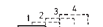

Miniature Slide Switches



Specifications: see page 102

Material: plastic housing, terminals sealed

Models: Switching functions

MFP 161 D
non-shorting

on on

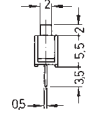
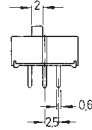

MFP 261 N
non-shorting

on on

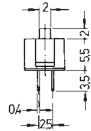
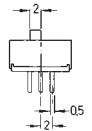

MFP 263 P
n.n.

on on on

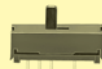
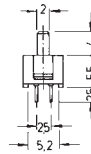
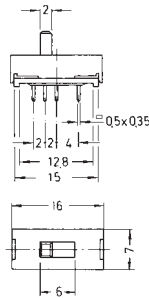

MFP 461 N
non-shorting

on on

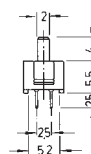
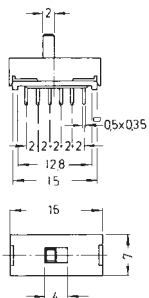

MFP 661 N
non-shorting

on on

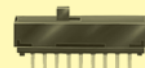
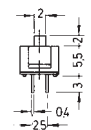
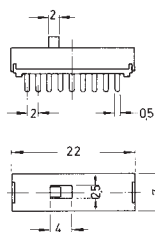

4

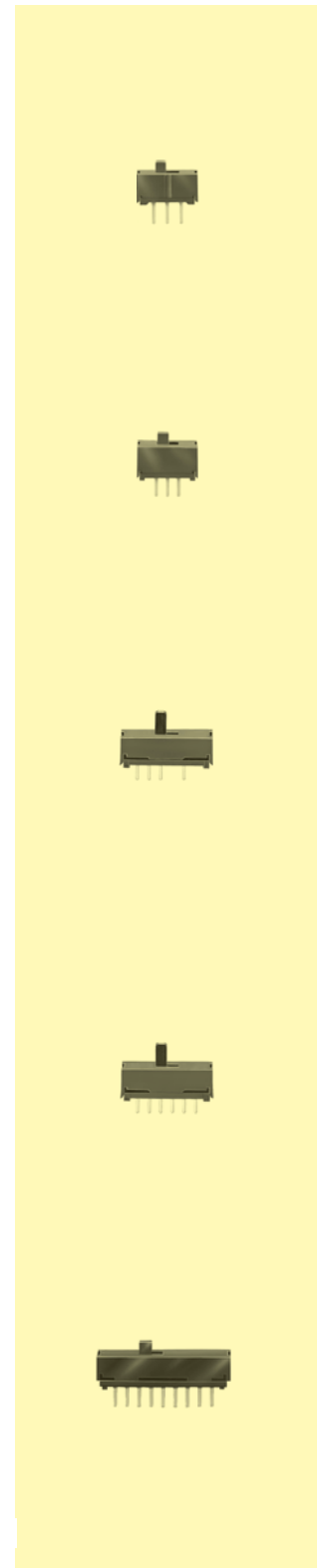



Miniature Slide Switches

Specifications: see page 102

Material: plastic housing, terminals sealed

Models: Switching functions

MFP 261 N – RA on on shorting

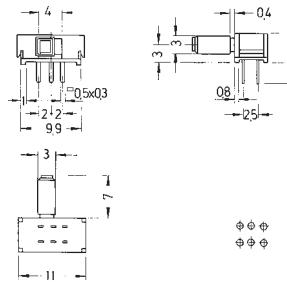

MFP 263 P – RA on on on n.n.

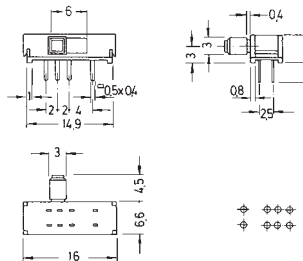

MFP 461 N – RA on on non-shorting

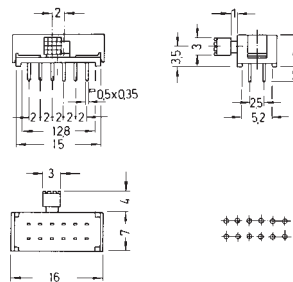

Miniature Slide Switches

Specifications:

Contact rating:	12 V DC, 100 mA
Contact resistance:	< 20 mΩ
Insulation resistance:	> 100 MΩ at 500 V DC
Dielectric strength:	500 V, 50 Hz for the duration of 1 minute
Operating temperature:	- 20 °C to + 85 °C
Mechanical life:	minimum 10 000 operations
Contacts:	copper alloy, silver-plated over nickel barrier
Slide colour:	black, further colours on request
Soldering conditions:	auto-soldering – max.: 5 sec, 260 °C ± 5 °C

Models:

MFP 113 D
non-shorting

Switching
functions

on on

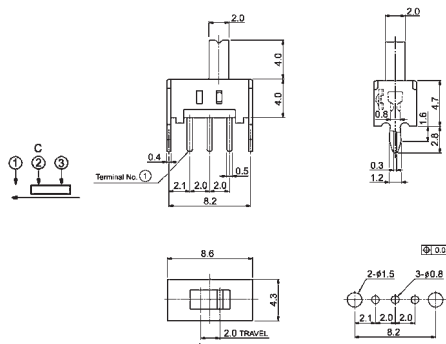

MFP 213 N
non-shorting

on on

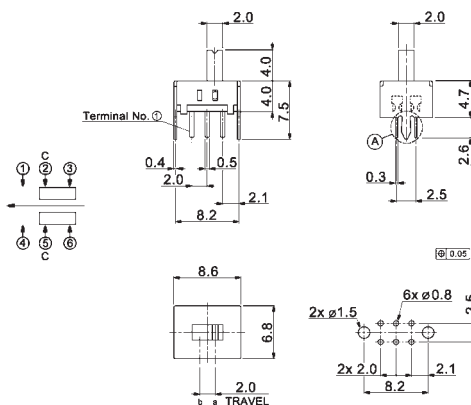

MFP 213 P
shorting

on on on

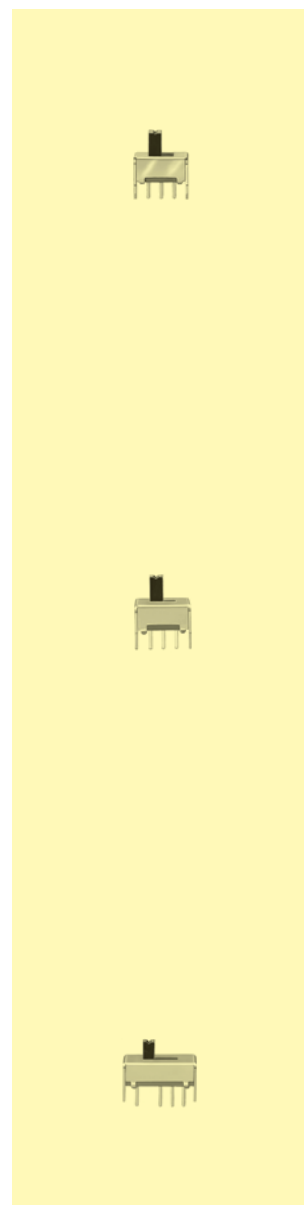
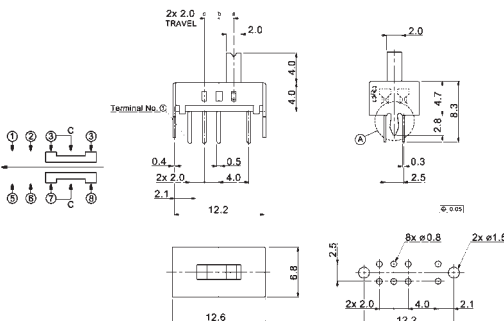



Miniature Slide Switches

Specifications:

Contact rating:	12 V DC, 100 mA
Contact resistance:	< 20 mΩ
Insulation resistance:	> 100 MΩ at 500 V DC
Dielectric strength:	500 V, 50 Hz for the duration of 1 minute
Operating temperature:	- 20 °C to + 85 °C
Mechanical life:	minimum 10 000 operations
Contacts:	copper alloy, silver-plated over nickel barrier
Slide colour:	black, further colours on request
Soldering conditions:	auto-soldering – max.: 5 sec, 260 °C ± 5 °C

Models: Switching functions

MFP 113 D – RA on on
non-shorting

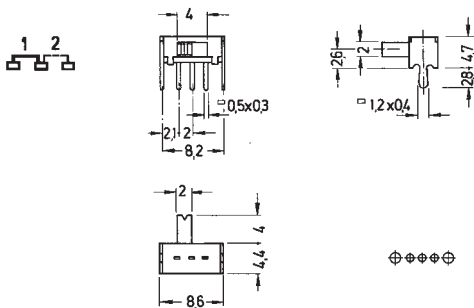

MFP 213 N – RA on on
non-shorting

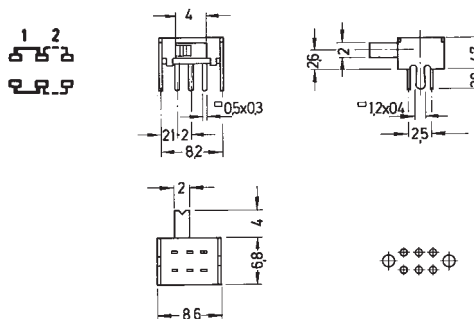

MFP 213 P – RA on on on
shorting

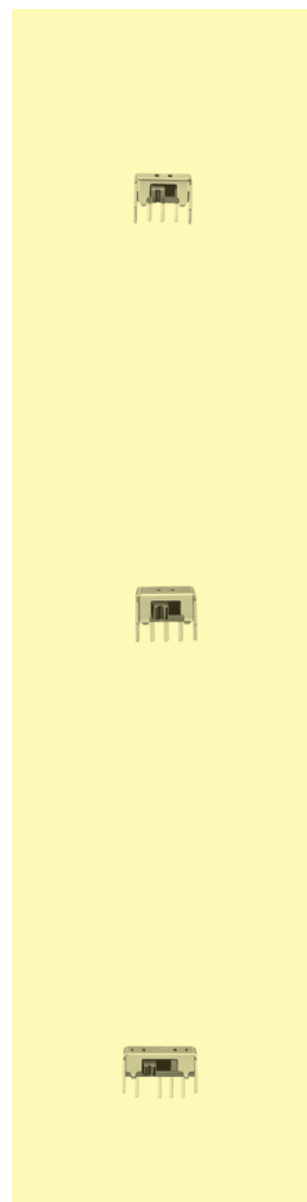
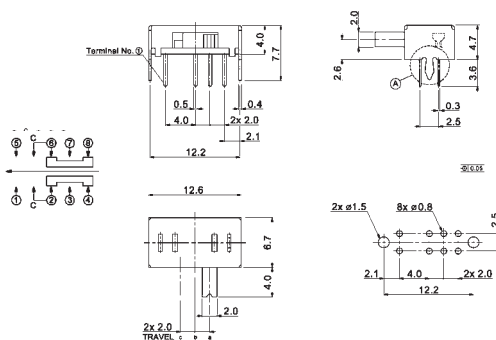

Miniature Slide Switches



Specifications:

Contact rating:	30 V DC, 350 mA
Contact resistance:	< 20 mΩ
Insulation resistance:	> 100 MΩ at 500 V DC
Dielectric strength:	500 V, 50 Hz for the duration of 1 minute
Operating temperature:	- 20 °C to + 85 °C
Mechanical life:	minimum 10 000 operations
Contacts:	copper alloy, silver-plated over nickel barrier
Contact timing:	non-shorting
Slide colour:	black, further colours on request
Soldering conditions:	auto-soldering – max.: 5 sec, 260 °C ± 5 °C

Models: Switching functions

MFP 102 D on on

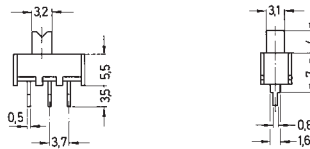

MFP 191 D on on

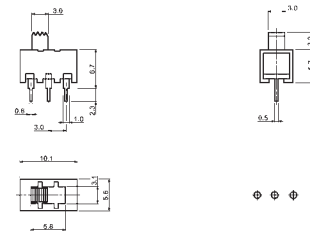

MFP 201 N on on

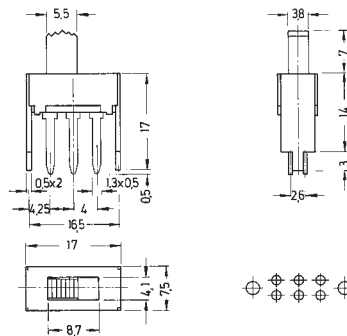

MFP 211 N on on

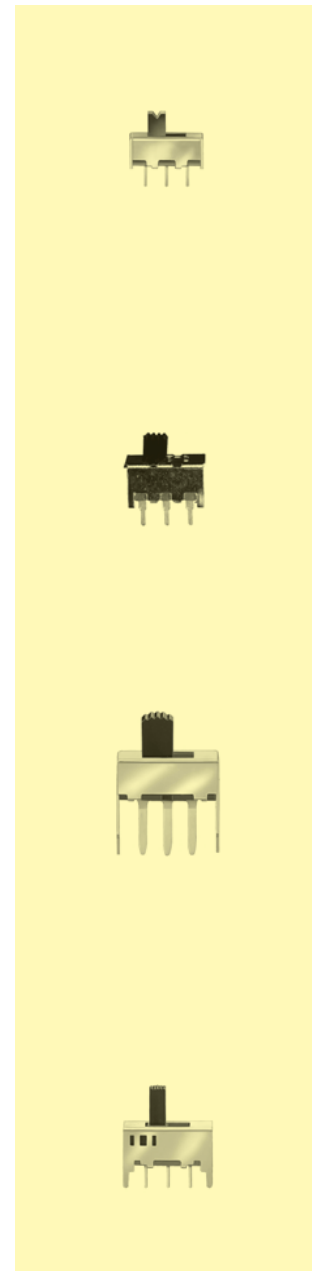
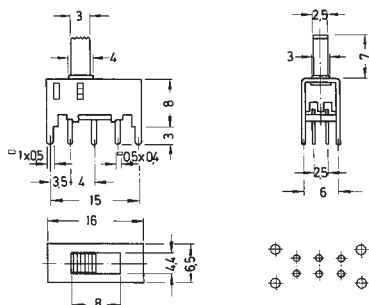



Miniature Slide Switches

Specifications:

Contact rating:	30 V DC, 350 mA
Contact resistance:	< 20 mΩ
Insulation resistance:	> 100 MΩ at 500 V DC; MFPP 130 – RA: 250 V DC
Dielectric strength:	500 V, 50 Hz for the duration of 1 minute
Operating temperature:	– 20 °C to + 85 °C
Mechanical life:	minimum 10 000 operations; MFPP 130 – RA > 100 000
Contacts:	copper alloy, silver-plated over nickel barrier
Slide colour:	black, further colours on request
Soldering conditions:	auto-soldering – max.: 5 sec, 260 °C ± 5 °C

Models: Switching functions

MFP 121 D – RA on on

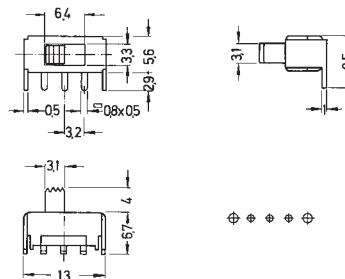

non-shorting

MFP 201 N – RA on on

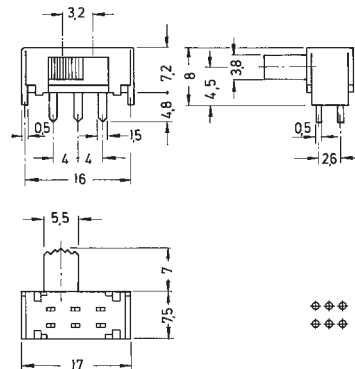

non-shorting

Miniature Slide Switches/ Pushbutton Switches

MFPP 130 – RA on on on

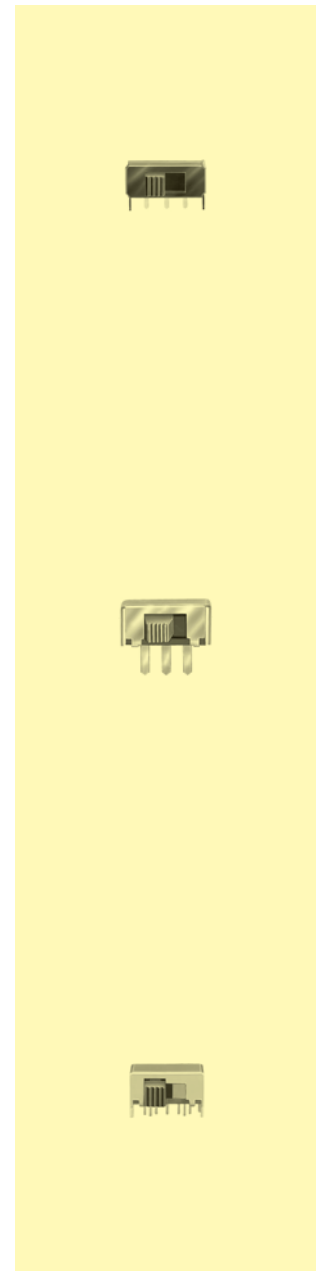
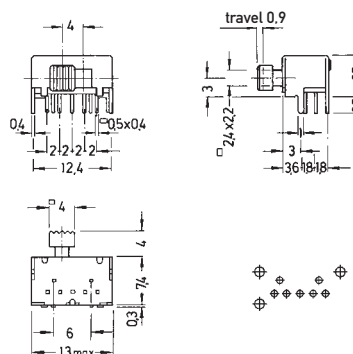

Miniature Slide Switches

Specifications:

Contact rating:	30 V DC, 350 mA
Contact resistance:	< 20 mΩ
Insulation resistance:	> 100 MΩ at 500 V DC
Dielectric strength:	500 V, 50 Hz for the duration of 1 minute
Operating temperature:	- 20 °C to + 85 °C
Mechanical life:	minimum 10 000 operations
Contacts:	copper alloy, silver-plated over nickel barrier
Slide colour:	black, further colours on request
Soldering conditions:	auto-soldering – max.: 5 sec, 260 °C ± 5 °C

Models: Switching functions

MFP 221 N
non-shorting

on on

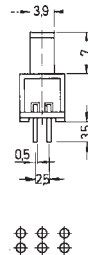
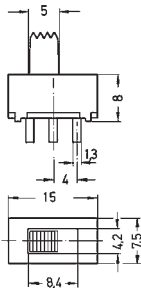

MFP 223 P
shorting

on on on

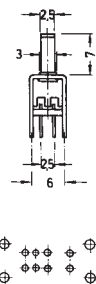
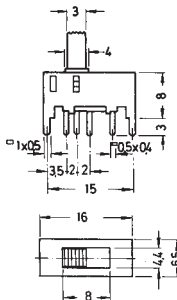

MFP 231 P
shorting

on on on

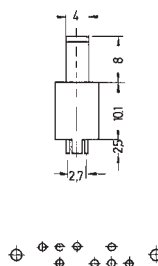
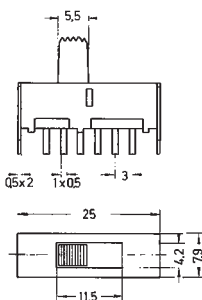

MFP 291 N
non-shorting

on on

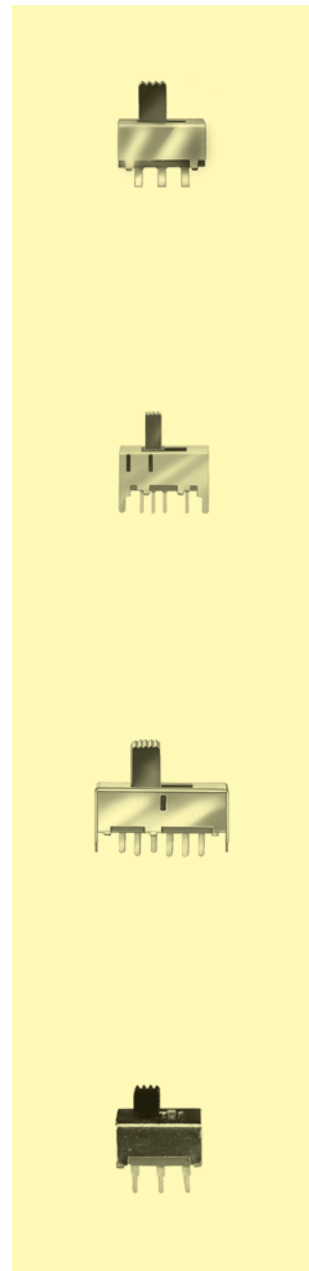
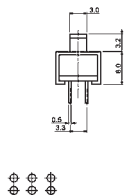
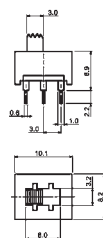



Miniature Slide Switches

Specifications:

Contact rating:	30 V DC, 350 mA
Contact resistance:	< 20 mΩ
Insulation resistance:	> 100 MΩ at 500 V DC
Dielectric strength:	500 V, 50 Hz for the duration of 1 minute
Operating temperature:	- 20 °C to + 85 °C
Mechanical life:	minimum 10 000 operations
Contacts:	copper alloy, silver-plated over nickel barrier
Slide colour:	black, further colours on request
Soldering conditions:	hand-soldering – max.: 5 sec, 270 °C

Models:

Switching functions

MFS 121 D
non-shorting

on on

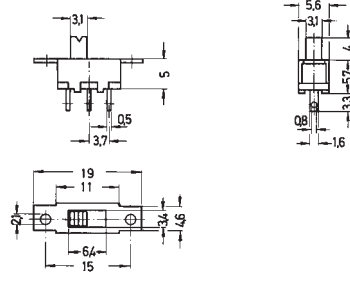

MFS 131 D
non-shorting

on on

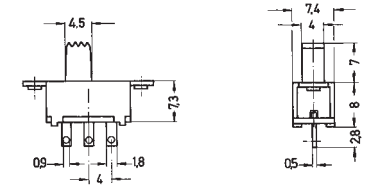

MFS 201 N
non-shorting

on on

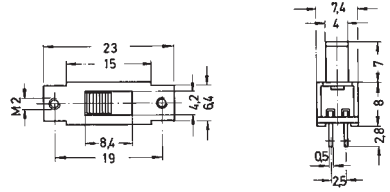

MFS 231 P
shorting

on on on

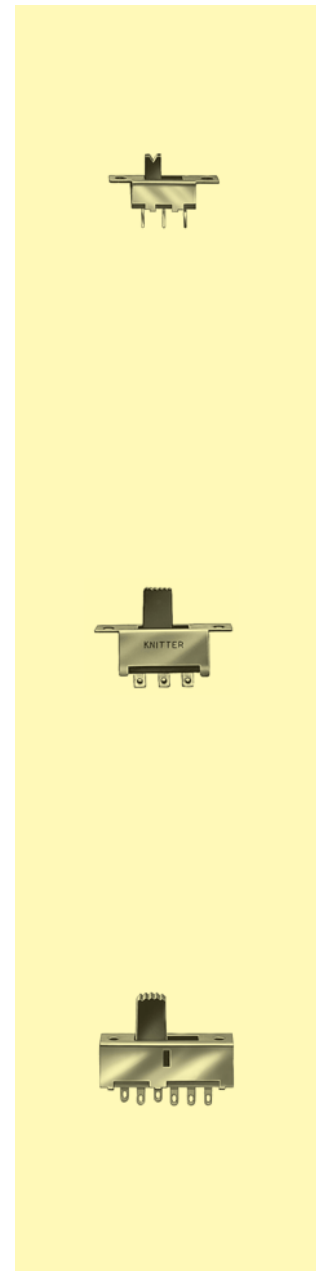
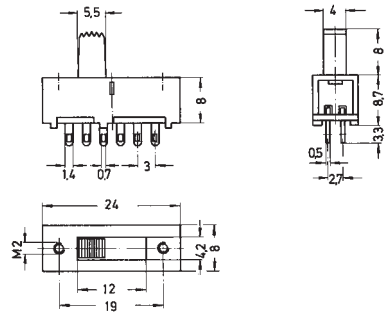

Microminiature Slide Switches

Specifications:

Contact rating:	12 V DC, 200 mA
Contact resistance:	< 50 mΩ
Insulation resistance:	> 100 MΩ at 500 V DC
Dielectric strength:	500 V, 50 Hz for the duration of 1 minute
Operating temperature:	- 10 °C to + 60 °C
Mechanical life:	minimum 5000 operations
Contacts:	phosphor bronze, silver-plated
Terminals:	brass silver-plated
Contact timing:	non-shorting
Soldering conditions:	auto-soldering – max.: 5 sec, 260 °C ± 5 °C

Models: Switching functions

MMP 121 on on

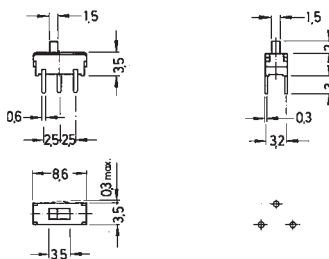

MMP 131 on on on

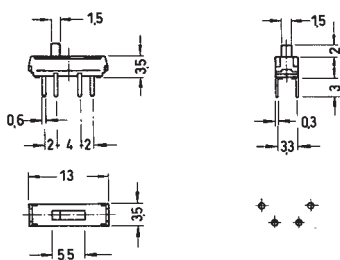

MMP 221 on on

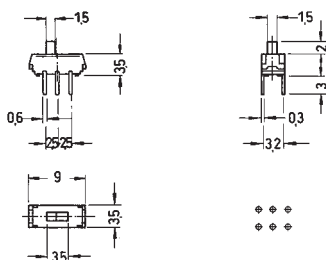

MMP 231 on on on

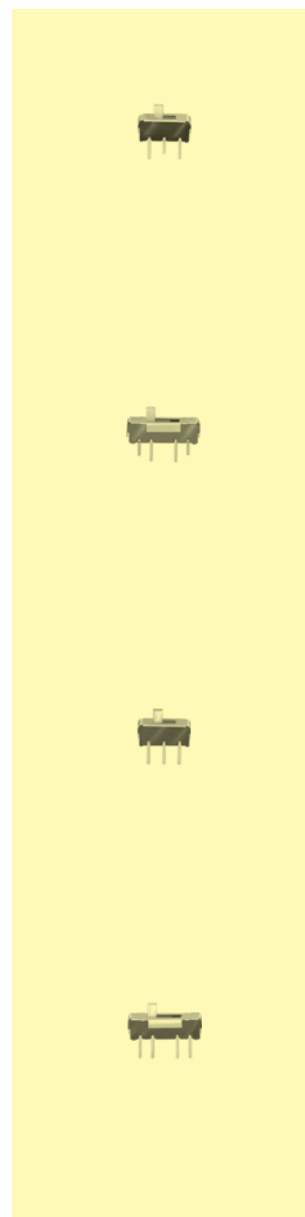
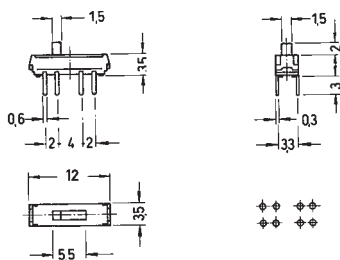



Microminiature Slide Switches

Models: Switching functions

MMP 121 – R on on

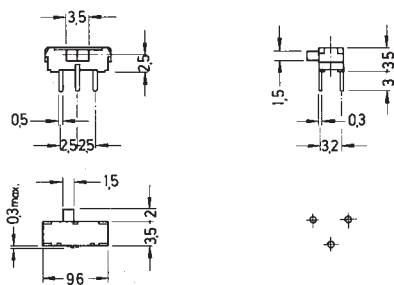

MMP 131 – R on on on

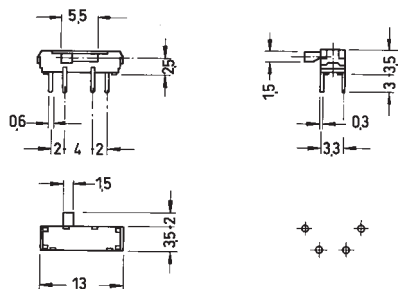

MMP 221 – R on on

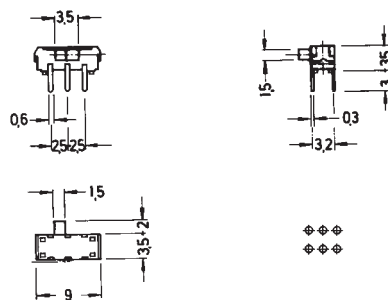

MMP 231 – R on on on

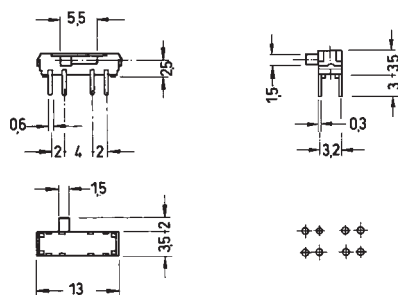

MMP 421 – R on on

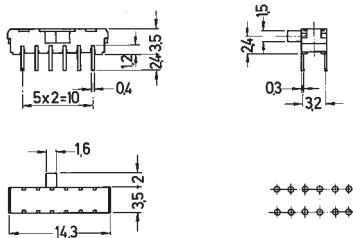
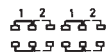

Microminiature Slide Switches

Specifications:

Contact rating:	12 V DC, 200 mA
Contact resistance:	< 50 mΩ
Insulation resistance:	> 100 MΩ at 500 V DC
Dielectric strength:	500 V, 50 Hz for the duration of 1 minute
Operating temperature:	- 10 °C to + 60 °C
Mechanical life:	minimum 5000 operations
Contacts:	phosphor bronze, silver-plated
Terminals:	brass, silver-plated
Contact timing:	non-shorting
Slide colour:	white; MMP 122 – R: black
Soldering conditions:	auto-soldering – max.: 5 sec, 260 °C ± 5 °C

Models: Switching functions

4	MMP 122 – R	on on					

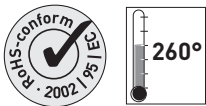

Microminiature Slide Switches for SMT

Specifications:

Contact rating:	12 V DC, 200 mA / 4 V DC, 300 mA
Contact resistance:	< 70 mΩ
Insulation resistance:	> 100 MΩ at 100 V DC
Dielectric strength:	500 V, 50 Hz for the duration of 1 minute
Operating temperature:	- 10 °C to + 60 °C
Mechanical life:	minimum 10 000 operations
Contacts:	phosphor bronze, gold-plated
Terminals:	brass, gold-plated
Contact timing:	non-shorting

Models:

MMSP 132 on on on
with pushbutton function

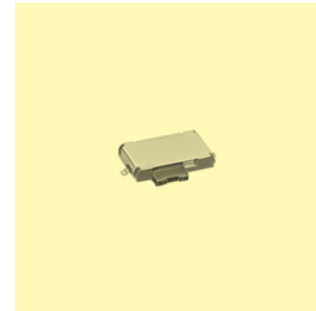
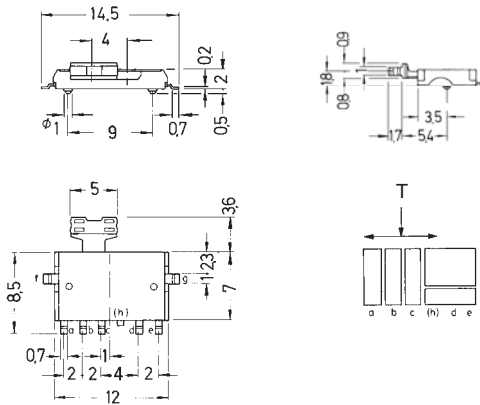

Packing:

1000 pcs/reel

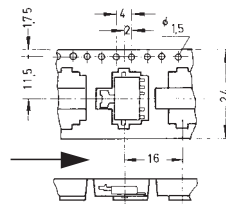

Ø 330 mm

Microminiature Slide Switches for SMT



Specifications:

Contact rating:	12 V DC, 200 mA
Contact resistance:	< 50 mΩ
Insulation resistance:	> 100 MΩ at 500 V DC
Dielectric strength:	500 V, 50 Hz for the duration of 1 minute
Operating temperature:	- 10 °C to + 60 °C
Storage temperature:	- 20 °C to + 70 °C
Mechanical life:	minimum 5000 operations
Contacts:	phosphor bronze, silver-plated
Terminals:	brass, silver-plated
Contact timing:	non-shorting
Slide colour:	white

Models: Switching functions

MMS 124 on on

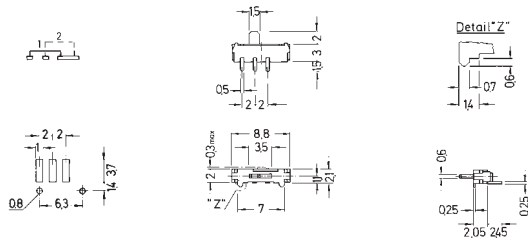

MMS 134 on on on

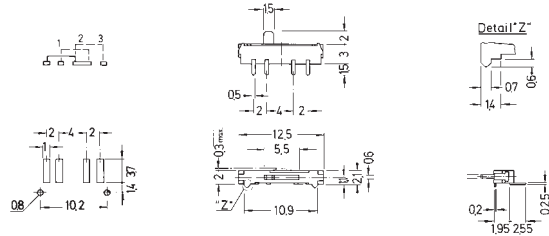

MMS 224 on on

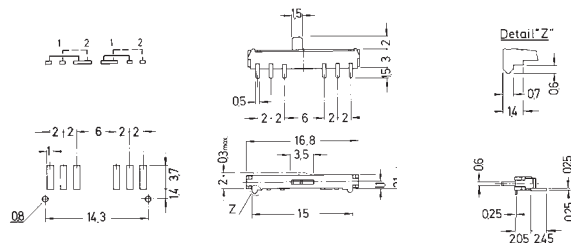

Soldering conditions: reflow-soldering – max.: 20 sec, 200° C
peak temperature: 250° C

Packing: cardboard boxes, on tapes on request

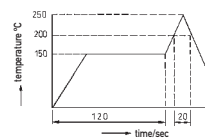
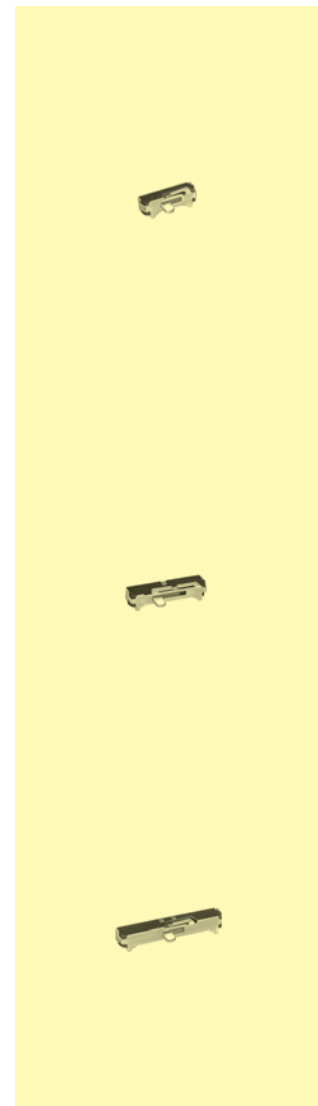

Microminiature Slide Switches

Specifications:

Contact rating:	0,2A, 24 V DC / 0,5A, 12 V DC
Contact resistance:	< 50 mΩ
Insulation resistance:	> 10 000 MΩ at 500 V DC
Dielectric strength:	500 V, 50 Hz for the duration of 1 minute
Operating temperature:	-25 °C to +70 °C
Mechanical life:	minimum 10 000 operations
Contacts:	phosphor bronze, gold-plated
Terminals:	brass, gold-plated
Soldering conditions:	MMP: auto-soldering – max.: 3 sec, 260 °C ± 3 °C MMS: reflow-soldering – max.: 5 sec, 260 °C ± 3 °C

Models: Switching functions

MMP 1010 D

on on

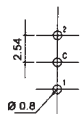
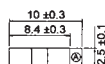
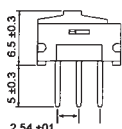

MMP 1010 D-RA

on on

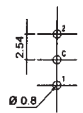
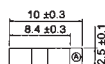
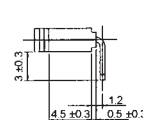
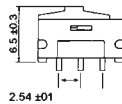

MMS 1010 D-R

on on

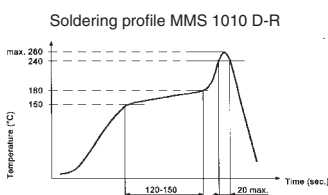
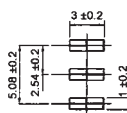
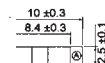
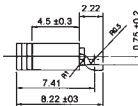
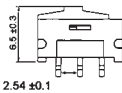



Microminiature Slide Switches

Specifications:

Contact rating:	24 V AC/DC, 0,3A / 12 V AC/DC, 0,5A
Contact resistance:	< 50 mΩ
Insulation resistance:	> 500 MΩ at 500 V DC
Dielectric strength:	500 V for the duration of 1 minute
Operating temperature:	- 40 °C to + 85 °C
Mechanical life:	minimum 10 000 operations
Contacts:	brass, gold-plated
Terminals:	brass, gold-plated
Case:	PA
Soldering conditions:	auto-soldering – max.: 5 sec ± 0,5 sec, 270 °C ± 5 °C

Models

Switching functions

MMP 1010 D – 1

on on

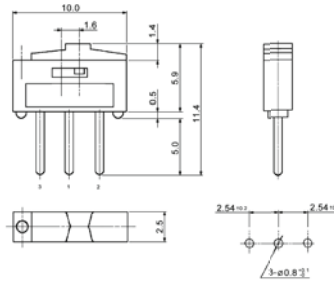

MMP 1010 D-RA – 1

on on

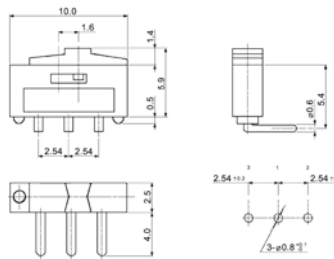

5

Dual-in-line Switches

5.1 Professional Dual-in-line Switches



Series	Poles	gold-plating	Actuator	SMD	Description	Page
Switches for maximum reliability and high specification						
DSS 100	2/4/6/8/10	0.6 µm	raised			130
Switches for professional application						
DSS 100 N	1 – 8/10/12	1.25 µm	raised			131
DSS 200 N	1 – 8/10/12	0.2 µm	raised			131
DBS 5000 G	2/4/6/8/10	0.3 µm	recessed		end-stackable	132
DBS 5100 G	2/4/6/8/10	0.3 µm	raised		end-stackable	132
SBS 5000 TG	2/4/6/8/10	0.3 µm	recessed	•	end-stackable	133
DSS 500	2/4/6/8/10	0.5 µm	recessed		low profile	134
SMS 500	2/4/6/8/10	0.3 µm	recessed	•	low profile	135
SBP 8000	2/4/6/8/10	0.3 µm	raised	•	piano type	136
DBP 8000	2/4/6/8/10	0.3 µm	raised	•	piano type	137
DHS 100	4/6/8/10	0.3 µm	recessed	•	half-pitch	138

5.2 Consumer Products

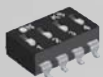

DHS 900	2/4/6/8/10/12	0.1 µm	recessed	•	half-pitch	139
DHS 900-J	2/4/6/8/10/12	0.1 µm	recessed	•	half-pitch, J-hooks	139
DBS 1000	2 – 10	0.1 µm	recessed			140
DBS 1100	2 – 10	0.1 µm	raised			140
DBS 9000 K	1 – 10/12		recessed		tin-plated terminals	141
DBS 9100 K	1 – 10/12		raised		tin-plated terminals	141
SBS 1000	1 – 10	0.1 µm	recessed	•		142
SBS 9000 TK	1 – 10/12		recessed	•	tin-plated terminals	143
SBS 9100 TK	1 – 10/12		raised	•	tin-plated terminals	143
SBS 9000 JTK	2 – 10/12		recessed	•	J-hooks/tin-plated terminals	144
DBS 5000	2/4/6/8/10	0.1 µm	recessed		end-stackable	145
DBS 5100	2/4/6/8/10	0.1 µm	raised		end-stackable	145
SBS 5000 T	2/4/6/8/10	0.1 µm	recessed	•	end-stackable	146
SBS 5100 T	2/4/6/8/10	0.1 µm	raised	•	end-stackable	146
DBS 2000	2 – 10/12	0.1 µm	recessed			147
DBS 2100	2 – 10/12	0.1 µm	raised			147
DBS 3000	2 – 10/12	0.1 µm	recessed			148
DBS 3100	2 – 10/12	0.1 µm	raised			148
DBP 2000	2 – 10/12	0.1 µm	recessed		piano type	149
DBP 2100	2 – 10/12	0.1 µm	raised		piano type	149
DBP 9100	2 – 6/8/10	0.1 µm	raised		piano type/tin-plated terminals	150
SBP 9100 T	2 – 6/8/10/12	0.1 µm	raised	•	piano type/tin-plated terminals	151

Dual-in-line Switches

Specifications:

Contact rating:	50 V DC, 100 mA
Contact resistance:	< 50 mΩ
Insulation resistance:	> 1000 MΩ at 100 V DC
Capacity:	< 5 pF between 2 poles
Dielectric strength:	500 V, 50 Hz for the duration of 1 minute
Operating temperature:	- 20 °C to + 80 °C
Mechanical life:	minimum 10 000 operations per pole
Shock resistance:	contact interruption < 10 μsec with triple shock in all 6 directions shock conditions: 20 G, 11 msec duration (sine half wave)
Vibration:	contact interruption < 10 μsec at vibration test in accordance with MIL-STD-202 D, method 204, condition C
Movable contacts:	Beryllium-Copper, 0.6 μm gold-plated over 0.1 μm Nickel
Fixed contacts:	Nickel silver, 0.6 μm gold-plated over 1 μm Nickel
Terminals:	Nickel silver, 0.04 μm gold-plated over 1 μm Nickel
Material:	case: PBT, slide: PA
Construction:	case sealed
Slide position:	OFF
Mounting:	on pc-board
Soldering conditions:	auto-soldering – max.: 3 sec, 270 °C

5

Models:

Series DSS 100

Type	Poles	Length (A)
DSS 102	2	6,6 mm
DSS 104	4	11,7 mm
DSS 106	6	16,8 mm
DSS 108	8	21,8 mm
DSS 110	10	26,9 mm

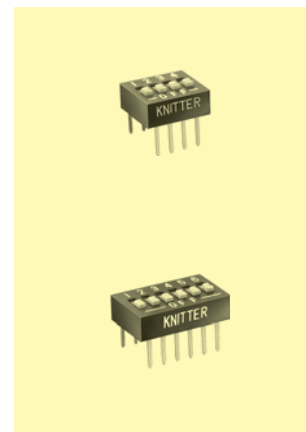
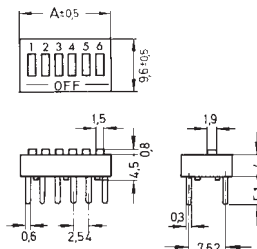



Dual-in-line Switches

Specifications:

Contact rating:	50 V DC, 100 mA
Contact resistance:	< 50 mΩ
Insulation resistance:	> 1000 MΩ at 100 V DC
Capacity:	< 5 pF between 2 poles
Dielectric strength:	500 V, 50 Hz for the duration of 1 minute
Operating temperature:	- 20 °C to + 80 °C
Mechanical life:	minimum 2000 operations per pole
Shock resistance:	contact interruption < 10 μsec with triple shock in all 6 directions shock conditions: 20 G, 11 msec duration (sine half wave)
Vibration:	contact interruption < 10 μsec at vibration test in accordance with MIL-STD-202 D, method 204, condition C
Contact/Terminals:	PC terminals, phosphor bronze, Series 100 N: 1,25 μm gold-plated over 1 μm nickel Series 200 N: 0,2 μm gold-plated over 1 μm nickel
Material:	case: PBT, slide: PA
Construction:	case sealed
Slide position:	OFF
Mounting:	on pc-board
Soldering conditions:	auto-soldering – max.: 5 sec, 260 °C

Models:

Series DSS 100 N

Type	Poles	Length (A)
DSS 101 N	1	3,90 mm
DSS 102 N	2	6,44 mm
DSS 103 N	3	8,98 mm
DSS 104 N	4	11,52 mm
DSS 105 N	5	14,06 mm
DSS 106 N	6	16,60 mm
DSS 107 N	7	19,14 mm
DSS 108 N	8	21,68 mm
DSS 110 N	10	26,76 mm
DSS 112 N	12	31,84 mm

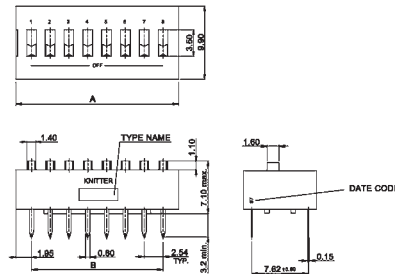

Series DSS 200 N

Type	Poles	Length (A)
DSS 201 N	1	3,90 mm
DSS 202 N	2	6,44 mm
DSS 203 N	3	8,98 mm
DSS 204 N	4	11,52 mm
DSS 205 N	5	14,06 mm
DSS 206 N	6	16,60 mm
DSS 207 N	7	19,14 mm
DSS 208 N	8	21,68 mm
DSS 210 N	10	26,76 mm
DSS 212 N	12	31,84 mm

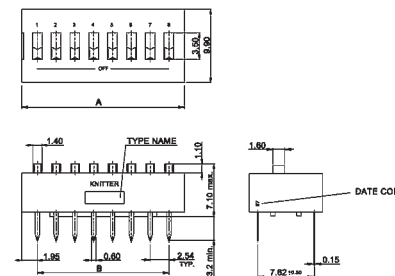

Dual-in-line Switches



Specifications:

Contact rating:	50 V DC, 100 mA (non-switching), 24 V DC, 25 mA (switching)
Contact resistance:	<100 mΩ
Insulation resistance:	>100 MΩ
Dielectric strength:	500 V, 50 Hz for the duration of 1 minute
Operating temperature:	-40 °C to +85 °C
Mechanical life:	minimum 5 000 operations per pole
Electrical life:	minimum 1 000 operations per pole
Shock resistance:	contact interruption <10 μs with triple shock in all 6 directions, shock conditions: 40 G, 11 ms duration (sin half wave)
Vibration:	contact interruption <10 μs at vibration test in accordance with MIL-STD 202 G, method 204, condition C
Materials:	Case: PA-9T, UL 94 V-0, black Slide: LCP, UL 94 V-0, white Contacts and Terminals: 0.3 μm gold-plated over Nickel
Construction:	Case sealed Series 5000 G: slide recessed, sealed with protective tape
Mounting:	on pc-board
Slide position:	OFF
Soldering conditions:	wave soldering, max. 10 sec max. 260 °C, pre-heat max. 60 sec max. 100 °C

Models:

Series DBS 5000 G

Type	Poles	Length (A)
DBS 5002 G	2	4,98 mm
DBS 5004 G	4	10,06 mm
DBS 5006 G	6	15,14 mm
DBS 5008 G	8	20,22 mm
DBS 5010 G	10	25,30 mm

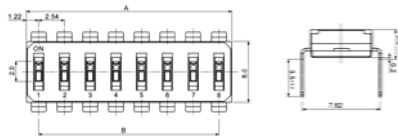

Serie DBS 5100 G

Type	Poles	Length (A)
DBS 5102 G	2	4,98 mm
DBS 5104 G	4	10,06 mm
DBS 5106 G	6	15,14 mm
DBS 5108 G	8	20,22 mm
DBS 5110 G	10	25,30 mm

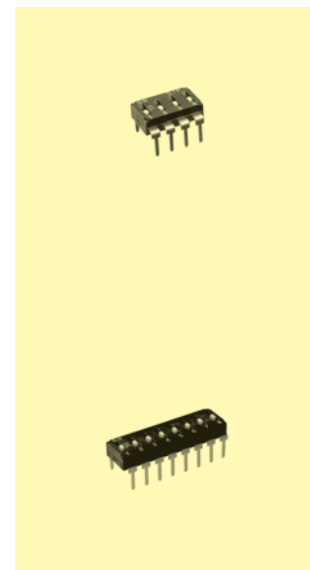
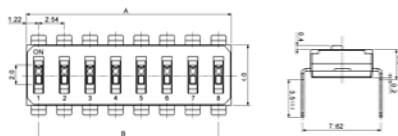

Packing:	sticks
Type	Stick
DBS 5002 / 5102 G	95 pieces
DBS 5004 / 5104 G	47 pieces
DBS 5006 / 5106 G	31 pieces
DBS 5008 / 5108 G	23 pieces
DBS 5010 / 5110 G	18 pieces

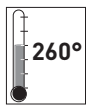

Dual-in-line Switches for SMT

Specifications:

Contact rating:	50 V DC, 100 mA (non-switching), 24 V DC, 25 mA (switching)
Contact resistance:	<100 mΩ
Insulation resistance:	>100 MΩ
Dielectric strength:	500 V, 50 Hz for the duration of 1 minute
Operating temperature:	-40 °C to +85 °C
Mechanical life:	minimum 5 000 operations per pole
Electrical life:	minimum 1 000 operations per pole
Shock resistance:	contact interruption <10 μs with triple shock in all 6 directions, shock conditions: 40 G, 11 ms duration (sin half wave)
Vibration:	contact interruption <10 μs at vibration test in accordance with MIL-STD 202 G, method 204, condition C
Materials:	Case: PA-9T, UL 94 V-0, black Slide: LCP, UL 94 V-0, white Contacts and Terminals: 0.3 μm gold-plated over Nickel
Construction:	Case sealed, slide recessed, sealed with protective tape
Mounting:	on pc-board – SMD
Slide position:	OFF

Models:

Series SBS 5000 TG

Type	Poles	Length (A)
SBS 5002 TG	2	4,98 mm
SBS 5004 TG	4	10,06 mm
SBS 5006 TG	6	15,14 mm
SBS 5008 TG	8	20,22 mm
SBS 5010 TG	10	25,30 mm

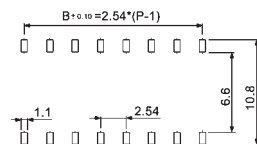
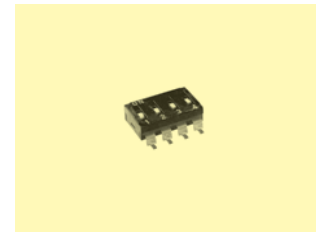
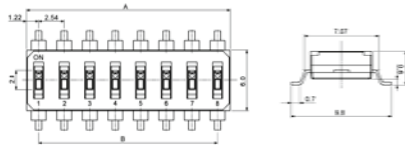

Packing: on tapes

Type	Tape	Reel	Tape width (A)
SBS 5002 TG	900 pieces;	Ø 300 mm	16,0 mm
SBS 5004 TG	900 pieces;	Ø 300 mm	24,0 mm
SBS 5006 TG	900 pieces;	Ø 300 mm	24,0 mm
SBS 5008 TG	900 pieces;	Ø 300 mm	32,0 mm
SBS 5010 TG	900 pieces;	Ø 300 mm	44,0 mm

Dual-in-line Switches ultra-low profile



Specifications:

Contact rating:	50 V DC, 100 mA
Contact resistance:	< 50 mΩ
Insulation resistance:	> 1000 MΩ at 100 V DC
Capacity:	< maximum 5 pF between 2 poles
Dielectric strength:	500 V, 50 Hz for the duration of 1 minute
Operating temperature:	- 20 °C to + 80 °C
Mechanical life:	minimum 1000 operations per pole
Shock resistance:	contact interruption < 10 μsec with triple shock in all 6 directions shock conditions: 20 G, 11 msec duration (sine half wave)
Vibration:	contact interruption: < 10 μsec at vibration test in accordance with MIL-STD-202 D, method 204, condition C
Contacts:	copper beryllium, gold-plated over nickel
Terminals:	PC terminals, nickel silver, gold-plated
Material:	case and slide: PA
Construction:	case sealed, slide recessed, sealed with protective tape
Mounting:	on pc-board
Slide position:	OFF
Soldering conditions:	auto-soldering – max.: 3 sec, 245 °C ± 10 °C

5

Models:

Series DSS 500

Type	Poles	Length (A)
DSS 502	2	6,30 mm
DSS 504	4	11,40 mm
DSS 506	6	16,50 mm
DSS 508	8	21,55 mm
DSS 510	10	26,65 mm

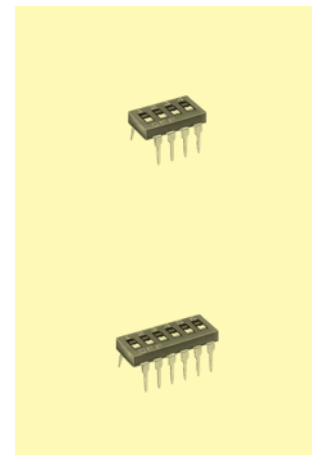
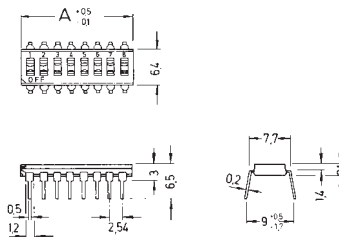

Dual-in-line Switches end-stackable

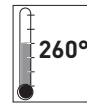

Specifications:

Contact rating:	24 V DC, 25 mA
Contact resistance:	< 100 mΩ
Insulation resistance:	> 100 MΩ
Dielectric strength:	500 V AC (50 Hz or 60 Hz) for 1 minute
Operating temperature:	- 20 °C to + 85 °C
Mechanical life:	minimum 2000 operations per pole
Material:	cover/base: high-temp. PA-9T UL 94 V-0, black; actuator: LCP UL 94 V-0, white
Contact:	copper; gold-plated at contact area
Terminal:	brass, gold-plated
Construction:	case sealed
Mounting:	on pc-board – SMD
Slide position:	OFF

Models:

Series SBP 8000

Type	Poles	Length (A)
SBP 8002 T	2	6,48 mm
SBP 8004 T	4	11,56 mm
SBP 8006 T	6	16,64 mm
SBP 8008 T	8	21,72 mm
SBP 8010 T	10	26,80 mm

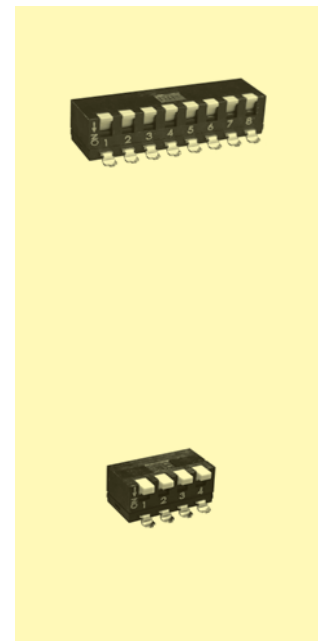
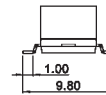
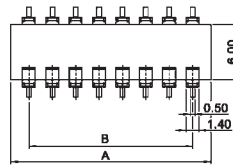

Series SBP 8100

Type	Poles	Length (A)
SBP 8102 T	2	6,48 mm
SBP 8104 T	4	11,56 mm
SBP 8106 T	6	16,64 mm
SBP 8108 T	8	21,72 mm
SBP 8110 T	10	26,80 mm

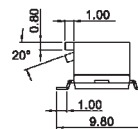
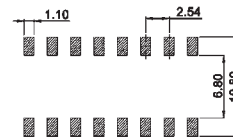

Packing: on tapes

Type	Tape	Reel	Tape width (A)
SBP 8002 T	700 pieces;	Ø 300 mm	16,0 mm
SBP 8004 T	700 pieces;	Ø 300 mm	24,0 mm
SBP 8006 T	700 pieces;	Ø 300 mm	24,0 mm
SBP 8008 T	700 pieces;	Ø 300 mm	32,0 mm
SBP 8010 T	700 pieces;	Ø 300 mm	44,0 mm
SBP 8102 T	700 pieces;	Ø 300 mm	16,0 mm
SBP 8104 T	700 pieces;	Ø 300 mm	24,0 mm
SBP 8106 T	700 pieces;	Ø 300 mm	24,0 mm
SBP 8108 T	700 pieces;	Ø 300 mm	32,0 mm
SBP 8110 T	700 pieces;	Ø 300 mm	44,0 mm



Dual-in-line Switches end-stackable

Specifications:

Contact rating:	24 V DC, 25 mA
Contact resistance:	< 100 mΩ
Insulation resistance:	> 100 MΩ
Dielectric strength:	500 V AC (50 Hz or 60 Hz) for 1 minute
Operating temperature:	- 40 °C to + 85 °C
Mechanical life:	minimum 2000 operations per pole
Material:	cover/base: PA-9T UL 94 V-0, black; actuator: LCP UL 94 V-0, white
Contacts:	copper, gold-plated at contact area
Terminals:	brass, gold-plated
Construction:	case sealed
Mounting:	on pc-board
Slide position:	OFF
Soldering conditions:	wave soldering – max.: 5 sec, 260 °C

Models:

Series DBP 8000

Type	Poles	Length (A)
DBP 8002	2	6,48 mm
DBP 8004	4	11,56 mm
DBP 8006	6	16,64 mm
DBP 8008	8	21,72 mm
DBP 8010	10	26,80 mm

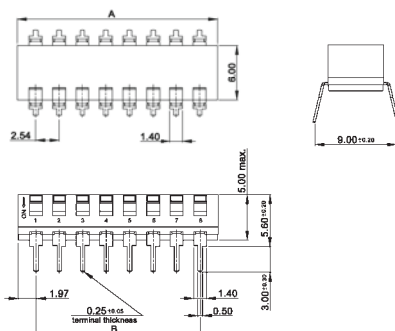

Series DBP 8100

Type	Poles	Length (A)
DBP 8102	2	6,48 mm
DBP 8104	4	11,56 mm
DBP 8106	6	16,64 mm
DBP 8108	8	21,72 mm
DBP 8110	10	26,80 mm

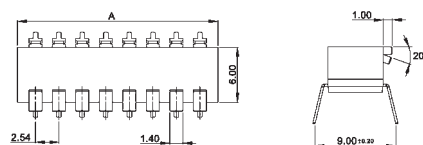

Circuit diagram

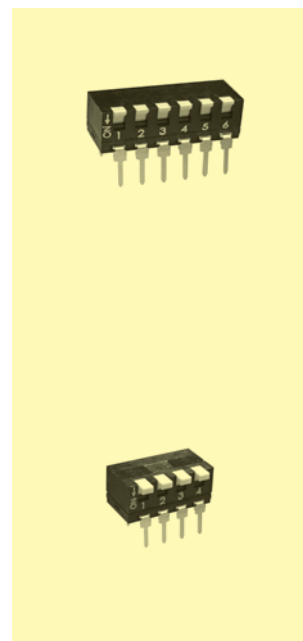

Packing: sticks

Type	Stick
DBP 8002 / 8102	70 pieces
DBP 8004 / 8104	40 pieces
DBP 8006 / 8106	28 pieces
DBP 8008 / 8108	20 pieces
DBP 8010 / 8110	16 pieces

Half-Pitch Dual-in-line Switches for SMT



Specifications:

Contact rating:	50 V DC, 100 mA
Contact resistance:	< 100 mΩ
Insulation resistance:	> 100 MΩ at 100 V DC
Dielectric strength:	250 V, 50 Hz for the duration of 1 minute
Operating temperature:	- 20 °C to + 80 °C
Storage temperature:	- 55 °C to + 85 °C
Mechanical life:	minimum 1000 operations per pole
Contacts/Terminals:	copper beryllium, gold-plated over nickel
Material:	case: PPS, black; slide: PA
Construction:	case sealed, slide recessed, sealed with protective tape
Mounting:	on pc-board – SMD – 1,27 mm
Slide position:	OFF
Soldering conditions:	reflow-soldering – max.: 10 sec, 250 °C max.

Models:	Poles	Length (A)
DHS 104	4	6,81 mm
DHS 106	6	9,35 mm
DHS 108	8	11,89 mm
DHS 110	10	14,43 mm

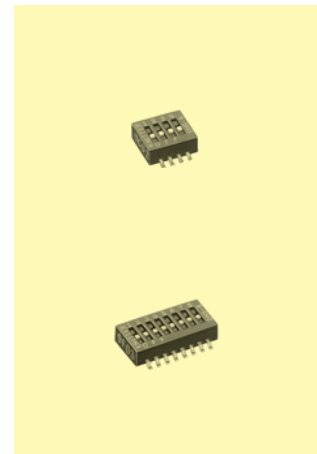
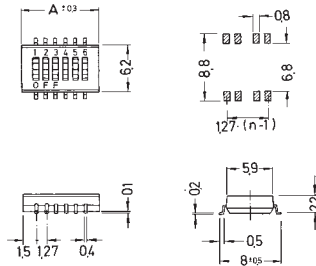

Packing: on tapes

Models	Tape	Reel	Tape width (A)	Rapport (R)
DHS 104	1000 pieces	∅ 250 mm	24,0 mm	12,0 mm
DHS 106	700 pieces	∅ 250 mm	24,0 mm	16,0 mm
DHS 108	1000 pieces	∅ 250 mm	24,0 mm	12,0 mm
DHS 110	700 pieces	∅ 250 mm	32,0 mm	16,0 mm

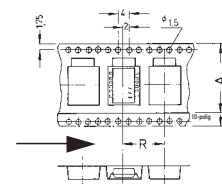

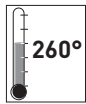

Half-Pitch Dual-in-line Switches for SMT

Specifications:

Contact rating:	24 V DC, 25 mA
Contact resistance:	< 50 mΩ
Insulation resistance:	100 MΩ at 100 V DC
Dielectric strength:	300 V AC for 1 minute
Operating temperature:	- 40 °C to + 85 °C
Mechanical life:	minimum 1000 operations per pole
Contacts/Terminals:	copper alloy, gold-plated over nickel
Material:	case: thermoplastic UL 94 V-0, black; actuator: thermoplastic UL 94 V-0, white
Mounting:	on pc-board – SMD – 1,27 mm
Construction:	case sealed, slide recessed, sealed with protective tape
Slide position:	OFF

Models:

Series DHS 900

Type	Poles	Length (A)
DHS 902	2	3,58 mm
DHS 904	4	6,12 mm
DHS 906	6	8,66 mm
DHS 908	8	11,20 mm
DHS 910	10	13,74 mm
DHS 912	12	16,28 mm

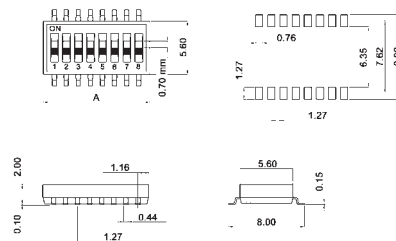

Series DHS 900-J

Type	Poles	Length (A)
DHS 902-J	2	3,58 mm
DHS 904-J	4	6,12 mm
DHS 906-J	6	8,66 mm
DHS 908-J	8	11,20 mm
DHS 910-J	10	13,74 mm
DHS 912-J	12	16,28 mm

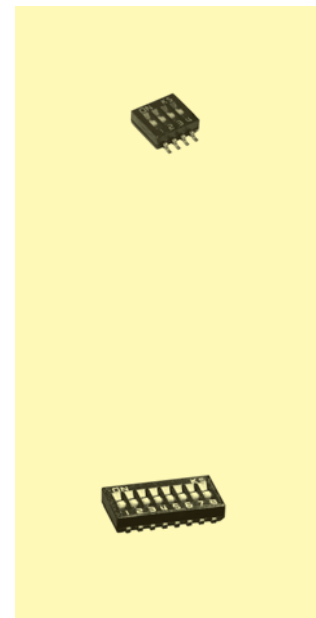
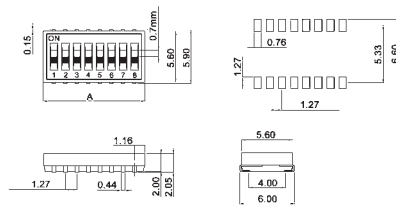

Packing: on tapes

Models	Tape	Reel	Tape width (A)
DHS 902 / DHS 902-J		3000 pieces; Ø 330 mm	16,0 mm
DHS 904 / DHS 904-J		2000 pieces; Ø 330 mm	16,0 mm
DHS 906 / DHS 906-J		2000 pieces; Ø 330 mm	16,0 mm
DHS 908 / DHS 908-J		2000 pieces; Ø 330 mm	24,0 mm
DHS 910 / DHS 910-J		2000 pieces; Ø 330 mm	24,0 mm
DHS 912 / DHS 912-J		2000 pieces; Ø 330 mm	24,0 mm

Dual-in-line Switches

Specifications:

Contact rating:	24 V DC, 25 mA / 6 V DC, 100 mA
Contact resistance:	< 50 mΩ
Insulation resistance:	> 100 MΩ at 500 V DC
Dielectric strength:	500 V, 50 Hz for the duration of 1 minute
Operating temperature:	- 40 °C to + 85 °C
Mechanical life:	minimum 2000 operations per pole
Material:	PPS meets UL 94 V-0
Contacts:	gold-plated over nickel
Construction:	case sealed
	series DBS 1000: slide recessed, front sealed with protective tape
Mounting:	on pc-board
Slide position:	OFF
Soldering conditions:	auto-soldering – max.: 5 sec, 260 °C

Models:

Series DBS 1000

Type	Poles	Length (A)
DBS 1002	2	6,02 mm
DBS 1003	3	8,56 mm
DBS 1004	4	11,10 mm
DBS 1005	5	13,64 mm
DBS 1006	6	16,18 mm
DBS 1007	7	18,72 mm
DBS 1008	8	21,26 mm
DBS 1009	9	23,80 mm
DBS 1010	10	26,34 mm

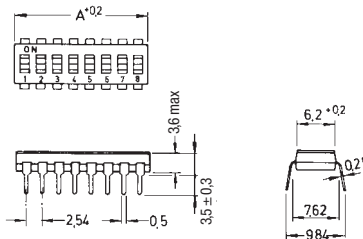

Series DBS 1100

Type	Poles	Length (A)
DBS 1102	2	6,02 mm
DBS 1103	3	8,56 mm
DBS 1104	4	11,10 mm
DBS 1105	5	13,64 mm
DBS 1106	6	16,18 mm
DBS 1107	7	18,72 mm
DBS 1108	8	21,26 mm
DBS 1109	9	23,80 mm
DBS 1110	10	26,34 mm

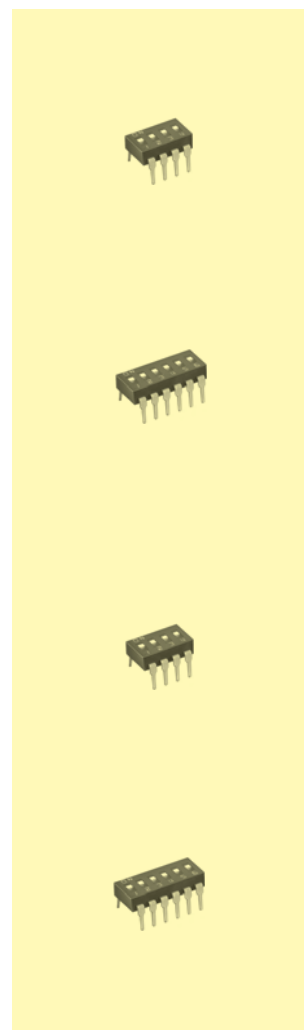
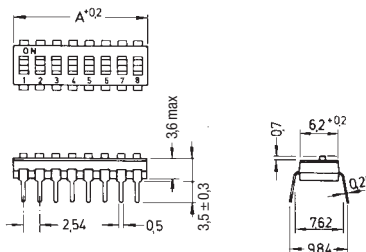



Dual-in-line Switches

Specifications:

Contact rating:	24 V DC, 25 mA
Contact resistance:	< 50 mΩ
Insulation resistance:	> 100 MΩ at 500 V DC
Dielectric strength:	500 V DC for 1 minute
Operating temperature:	- 40 °C to + 85 °C
Mechanical life:	minimum 5000 operations per pole
Material:	cover/base: PPS UL 94 V-0, black; actuator: PA66 UL 94 V-0, white
Contacts/Terminals:	brass, tin-plated
Construction:	case sealed
	series DBS 9000 K: slide recessed, front sealed with protective tape
Mounting:	on pc-board
Slide position:	OFF
Soldering conditions:	auto-soldering – max.: 10 sec, 260 °C ± 10 °C

Models:

Series DBS 9000 K

Type	Poles	Length (A)
DBS 9001 K	1	2,98 mm
DBS 9002 K	2	5,52 mm
DBS 9003 K	3	8,06 mm
DBS 9004 K	4	10,60 mm
DBS 9005 K	5	13,14 mm
DBS 9006 K	6	15,68 mm
DBS 9007 K	7	18,22 mm
DBS 9008 K	8	20,76 mm
DBS 9009 K	9	23,30 mm
DBS 9010 K	10	25,84 mm
DBS 9012 K	12	30,92 mm

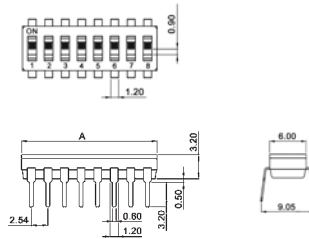

Series DBS 9100 TK

Type	Poles	Length (A)
DBS 9101 K	1	2,98 mm
DBS 9102 K	2	5,52 mm
DBS 9103 K	3	8,06 mm
DBS 9104 K	4	10,60 mm
DBS 9105 K	5	13,14 mm
DBS 9106 K	6	15,68 mm
DBS 9107 K	7	18,22 mm
DBS 9108 K	8	20,76 mm
DBS 9109 K	9	23,30 mm
DBS 9110 K	10	25,84 mm
DBS 9112 K	12	30,92 mm

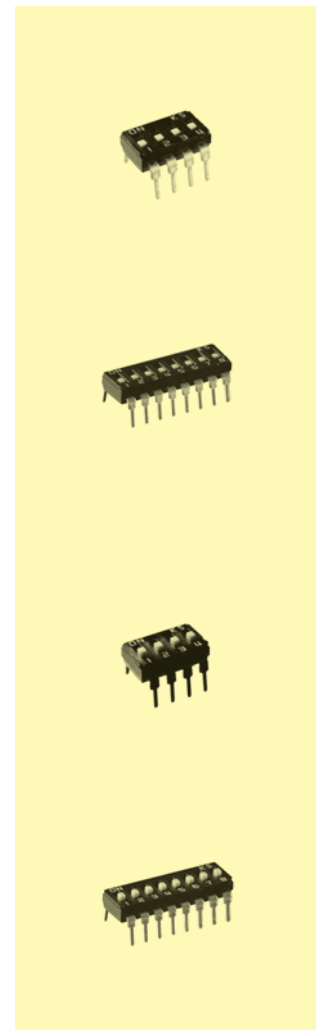
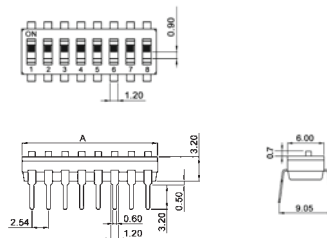

Dual-in-line Switches for SMT

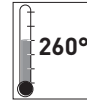

Specifications:

Contact rating:	24 V DC, 25 mA / 6 V DC, 100 mA
Contact resistance:	< 50 mΩ
Insulation resistance:	> 100 MΩ at 500 V DC
Dielectric strength:	500 V, 50 Hz for the duration of 1 minute
Operating temperature:	- 40 °C to + 85 °C
Mechanical life:	minimum 2000 operations per pole
Material:	PPS meets UL 94 V-0
Contacts:	gold-plated over nickel
Construction:	case sealed, slide recessed, front sealed with protective tape
Mounting:	on pc-board – SMD
Slide position:	OFF

Models:

Series SBS 1000

Type	Poles	Length (A)
SBS 1001	1	3,48 mm
SBS 1002	2	6,02 mm
SBS 1003	3	8,56 mm
SBS 1004	4	11,10 mm
SBS 1005	5	13,64 mm
SBS 1006	6	16,18 mm
SBS 1007	7	18,72 mm
SBS 1008	8	21,26 mm
SBS 1009	9	23,80 mm
SBS 1010	10	26,34 mm

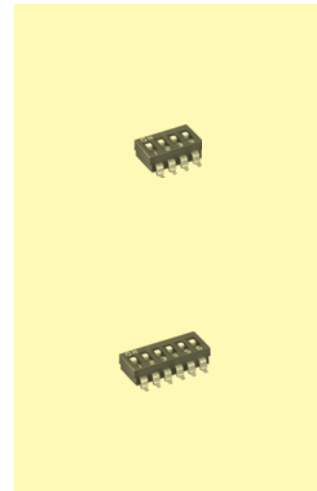
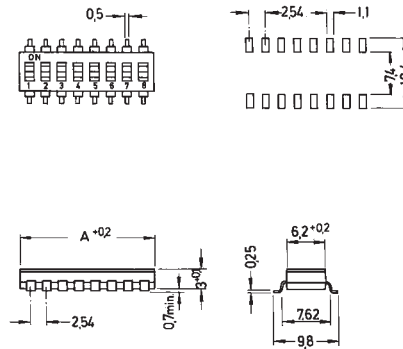

Packing: sticks or tapes
for order on tapes: additional to type number: T
example of order: SBS 1002 T

Models:	Stick	Tape/Reel	Tape width (A)
SBS 1001	–	800 pieces; Ø 330 mm	16,0 mm
SBS 1002	76 pieces	900 pieces; Ø 330 mm	16,0 mm
SBS 1003	55 pieces	900 pieces; Ø 330 mm	24,0 mm
SBS 1004	42 pieces	900 pieces; Ø 330 mm	24,0 mm
SBS 1005	35 pieces	900 pieces; Ø 330 mm	24,0 mm
SBS 1006	28 pieces	900 pieces; Ø 330 mm	24,0 mm
SBS 1007	25 pieces	900 pieces; Ø 330 mm	32,0 mm
SBS 1008	22 pieces	900 pieces; Ø 330 mm	32,0 mm
SBS 1009	20 pieces	900 pieces; Ø 330 mm	44,0 mm
SBS 1010	18 pieces	900 pieces; Ø 330 mm	44,0 mm

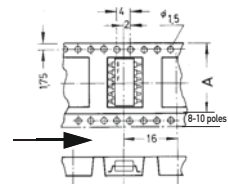

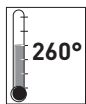

Dual-in-line Switches for SMT

Specifications:

Contact rating:	24 V DC, 25 mA
Contact resistance:	< 50 mΩ
Insulation resistance:	> 100 MΩ at 500 V DC
Dielectric strength:	500 V DC for 1 minute
Operating temperature:	- 40 °C to + 85 °C
Mechanical life:	minimum 5 000 operations per pole
Material:	cover/base: PPS UL 94 V-0, black; actuator: PA66 UL 94 V-0, white
Contacts/Terminals:	brass, tin-plated
Construction:	case sealed
	series SBS 9000 TK: slide recessed, front sealed with protective tape
Mounting:	on pc-board – SMD
Slide position:	OFF

Models:

Series SBS 9000 TK / SBS 9100 TK

Type	Poles	Length (A)
SBS 9001 TK / 9101 TK	1	2,98 mm
SBS 9002 TK / 9102 TK	2	5,52 mm
SBS 9003 TK / 9103 TK	3	8,06 mm
SBS 9004 TK / 9104 TK	4	10,60 mm
SBS 9005 TK / 9105 TK	5	13,14 mm
SBS 9006 TK / 9106 TK	6	15,68 mm
SBS 9007 TK / 9107 TK	7	18,22 mm
SBS 9008 TK / 9108 TK	8	20,76 mm
SBS 9009 TK / 9109 TK	9	23,30 mm
SBS 9010 TK / 9110 TK	10	25,84 mm
SBS 9012 TK / 9112 TK	12	30,92 mm

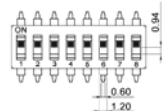
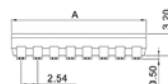

PCB Layout

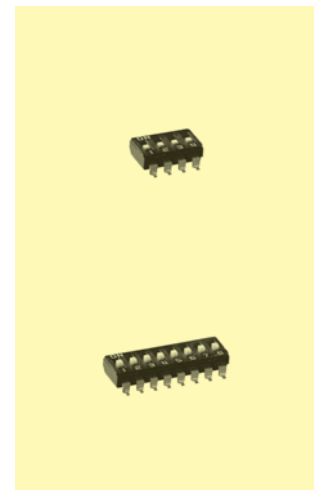
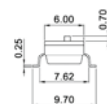
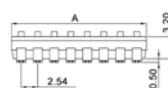

Packing: on tapes

Type	Tape	Reel	Tape width (A)
SBS 9001 TK / SBS 9101 TK	2000 pieces/1500 pieces;	Ø 330 mm	16,0 mm
SBS 9002 TK / SBS 9102 TK	2000 pieces/1500 pieces;	Ø 330 mm	16,0 mm
SBS 9003 TK / SBS 9103 TK	1000 pieces/ 800 pieces;	Ø 330 mm	16,0 mm
SBS 9004 TK / SBS 9104 TK	1000 pieces/ 800 pieces;	Ø 330 mm	24,0 mm
SBS 9005 TK / SBS 9105 TK	1000 pieces/ 800 pieces;	Ø 330 mm	24,0 mm
SBS 9006 TK / SBS 9106 TK	1000 pieces/ 800 pieces;	Ø 330 mm	24,0 mm
SBS 9007 TK / SBS 9107 TK	1000 pieces/ 800 pieces;	Ø 330 mm	32,0 mm
SBS 9008 TK / SBS 9108 TK	1000 pieces/ 800 pieces;	Ø 330 mm	32,0 mm
SBS 9009 TK / SBS 9109 TK	1000 pieces/ 800 pieces;	Ø 330 mm	44,0 mm
SBS 9010 TK / SBS 9110 TK	1000 pieces/ 800 pieces;	Ø 330 mm	44,0 mm
SBS 9012 TK / SBS 9112 TK	1000 pieces/ 800 pieces;	Ø 330 mm	44,0 mm



Dual-in-line Switches end-stackable

Specifications:

Contact rating:	24 V DC, 25 mA
Contact resistance:	< 100 mΩ
Insulation resistance:	> 100 MΩ
Dielectric strength:	500 V AC (50 Hz or 60 Hz) for 1 minute
Operating temperature:	- 40 °C to + 85 °C
Mechanical life:	minimum 2000 operations per pole
Material:	cover/base: PA-9T UL 94 V-0, black; actuator: LCP UL 94 V-0, white
Contacts:	copper, gold-plated at contact area
Terminals:	brass, gold-plated
Construction:	case sealed series DBS 5000: slide recessed, front sealed with protective tape
Mounting:	on pc-board
Slide position:	OFF
Soldering conditions:	wave soldering – max.: 5 sec, 260 °C

Models:

Series DBS 5000

Type	Poles	Length (A)
DBS 5002	2	4,98 mm
DBS 5004	4	10,06 mm
DBS 5006	6	15,14 mm
DBS 5008	8	20,22 mm
DBS 5010	10	25,30 mm

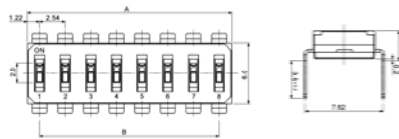

Series DBS 5100

Type	Poles	Length (A)
DBS 5102	2	4,98 mm
DBS 5104	4	10,06 mm
DBS 5106	6	15,14 mm
DBS 5108	8	20,22 mm
DBS 5110	10	25,30 mm

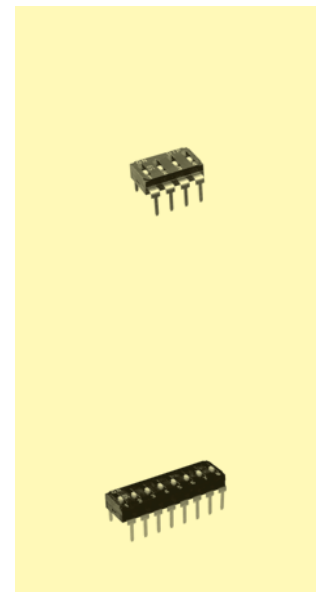
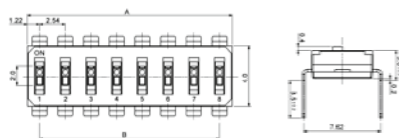

Packing: sticks

Type	Stick
DBS 5002 / 5102	95 pieces
DBS 5004 / 5104	47 pieces
DBS 5006 / 5106	31 pieces
DBS 5008 / 5108	23 pieces
DBS 5010 / 5110	18 pieces

Dual-in-line Switches end-stackable, for SMT

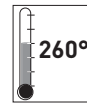

Specifications:

Contact rating:	24 V DC, 25 mA
Contact resistance:	< 100 mΩ
Insulation resistance:	> 100 MΩ
Dielectric strength:	500 V AC (50 Hz or 60 Hz) for 1 minute
Operating temperature:	- 40 °C to + 85 °C
Mechanical life:	minimum 2000 operations per pole
Material:	cover/base: high-temp. PA-9T UL 94 V-0, black; actuator: LCP UL 94 V-0, white
Contact:	copper; gold-plated at contact area
Terminal:	brass, gold-plated
Construction:	case sealed
	series SBS 5000: slide recessed, front sealed with protective tape
Mounting:	on pc-board – SMD
Slide position:	OFF

Models:

Series SBS 5000

Type	Poles	Length (A)
SBS 5002 T	2	4,98 mm
SBS 5004 T	4	10,06 mm
SBS 5006 T	6	15,14 mm
SBS 5008 T	8	20,22 mm
SBS 5010 T	10	25,30 mm

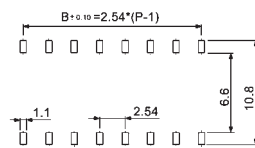
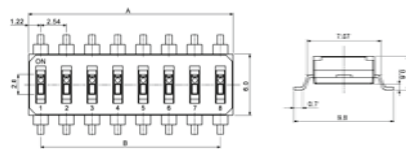

Series SBS 5100

Type	Poles	Length (A)
SBS 5102 T	2	4,98 mm
SBS 5104 T	4	10,06 mm
SBS 5106 T	6	15,14 mm
SBS 5108 T	8	20,22 mm
SBS 5110 T	10	25,30 mm

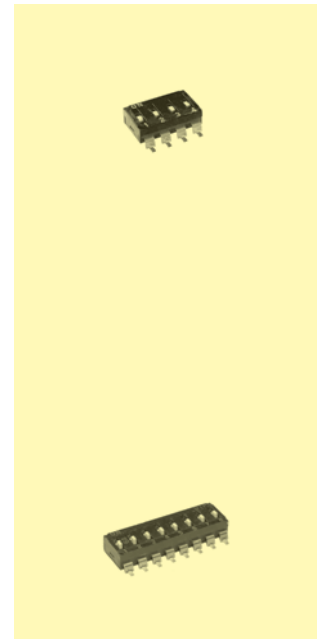
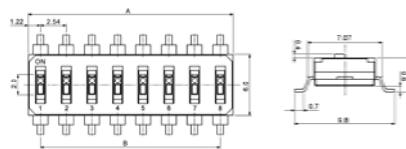

Packing: on tapes

Type	Tape	Reel	Tape width (A)
SBS 5002 T	900 pieces;	Ø 300 mm	16,0 mm
SBS 5004 T	900 pieces;	Ø 300 mm	24,0 mm
SBS 5006 T	900 pieces;	Ø 300 mm	24,0 mm
SBS 5008 T	900 pieces;	Ø 300 mm	32,0 mm
SBS 5010 T	900 pieces;	Ø 300 mm	44,0 mm
SBS 5102 T	900 pieces;	Ø 300 mm	16,0 mm
SBS 5104 T	900 pieces;	Ø 300 mm	24,0 mm
SBS 5106 T	900 pieces;	Ø 300 mm	24,0 mm
SBS 5108 T	900 pieces;	Ø 300 mm	32,0 mm
SBS 5110 T	900 pieces;	Ø 300 mm	44,0 mm



Dual-in-line Switches

Specifications:

Contact rating:	24 V DC, 25 mA / 6 V DC, 100 mA
Contact resistance:	< 50 mΩ
Insulation resistance:	> 100 MΩ at 500 V DC
Dielectric strength:	500 V, 50 Hz for the duration of 1 minute
Operating temperature:	- 20 °C to + 70 °C
Mechanical life:	minimum 2000 operations per pole
Material:	PBT meets UL 94 V-0
Contacts:	gold-plated over nickel
Construction:	case sealed
	series DBS 2000 slide recessed, sealed with protective tape
Mounting:	on pc-board
Slide position:	OFF
Soldering conditions:	auto-soldering – max.: 5 sec, 260 °C

Models:

Series DBS 2000

Type	Poles	Length (A)
DBS 2002	2	6,44 mm
DBS 2003	3	8,98 mm
DBS 2004	4	11,52 mm
DBS 2005	5	14,06 mm
DBS 2006	6	16,60 mm
DBS 2007	7	19,14 mm
DBS 2008	8	21,68 mm
DBS 2009	9	24,22 mm
DBS 2010	10	26,76 mm
DBS 2012	12	31,84 mm

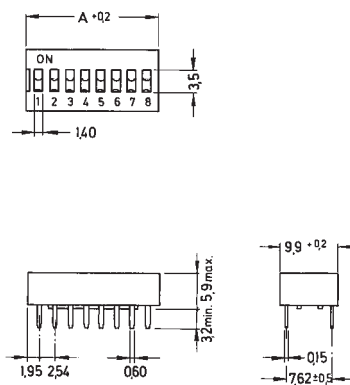

Series DBS 2100

Type	Poles	Length (A)
DBS 2102	2	6,44 mm
DBS 2103	3	8,98 mm
DBS 2104	4	11,52 mm
DBS 2105	5	14,06 mm
DBS 2106	6	16,60 mm
DBS 2107	7	19,14 mm
DBS 2108	8	21,68 mm
DBS 2109	9	24,22 mm
DBS 2110	10	26,76 mm
DBS 2112	12	31,84 mm

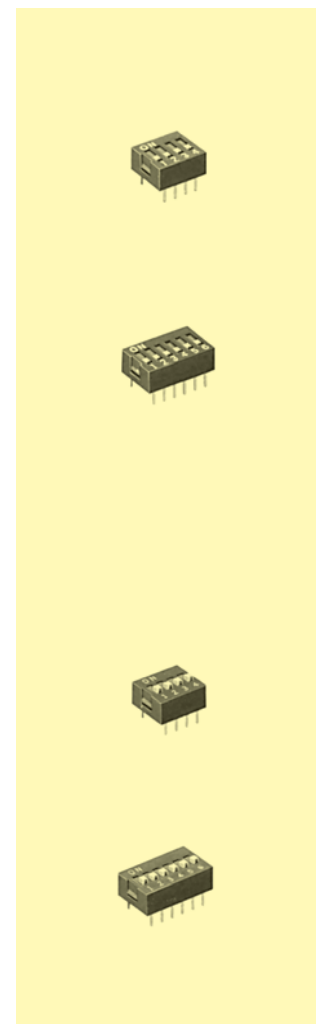
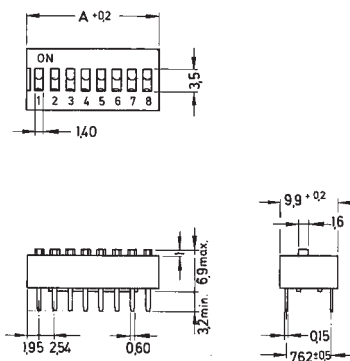

Dual-in-line Switches

Specifications:

Contact rating:	24 V DC, 25 mA
Contact resistance:	< 50 mΩ
Insulation resistance:	> 100 MΩ at 500 V DC
Dielectric strength:	500 V, 50 Hz for the duration of 1 minute
Operating temperature:	- 40 °C to + 85 °C
Mechanical life:	minimum 3000 operations per pole
Material:	PBT meets UL 94 V-0
Contacts:	copper-alloy, gold-plated
Terminals:	copper-alloy, tin-plated
Case:	PA, red, slider: PA, white
Construction:	case sealed
	DBS 3000: slide recessed, sealed with protective tape
Slide position:	OFF
Mounting:	on pc-board
Soldering conditions:	auto-soldering – max.: 10 sec, max 260 °C

Models:

Series DBS 3000

Type	Poles	Length (A)
DBS 3001	1	3,54 mm
DBS 3002	2	6,08 mm
DBS 3003	3	8,62 mm
DBS 3004	4	11,16 mm
DBS 3005	5	13,70 mm
DBS 3006	6	16,24 mm
DBS 3007	7	18,78 mm
DBS 3008	8	21,32 mm
DBS 3009	9	23,86 mm
DBS 3010	10	26,40 mm
DBS 3012	12	31,48 mm

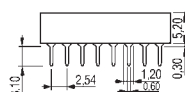
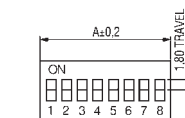

Series DBS 3100

Type	Poles	Length (A)
DBS 3101	1	3,54 mm
DBS 3102	2	6,08 mm
DBS 3103	3	8,62 mm
DBS 3104	4	11,16 mm
DBS 3105	5	13,70 mm
DBS 3106	6	16,24 mm
DBS 3107	7	18,78 mm
DBS 3108	8	21,32 mm
DBS 3109	9	23,86 mm
DBS 3110	10	26,40 mm
DBS 3112	12	31,48 mm

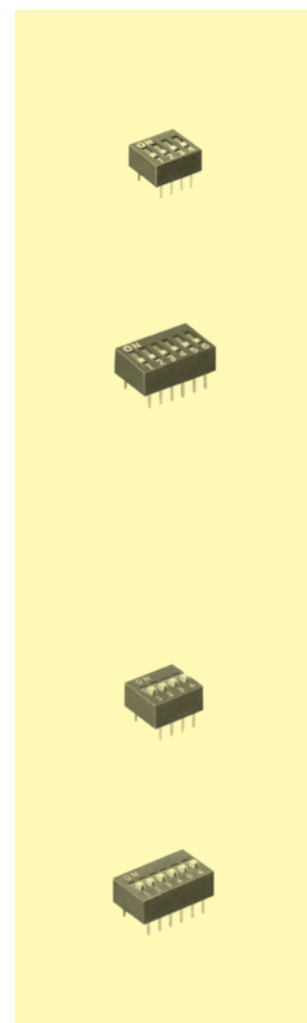
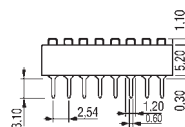
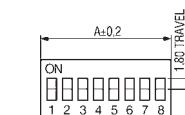



Dual-in-line Switches

Specifications:

Contact rating:	24 V DC, 25 mA / 6 V DC, 100 mA
Contact resistance:	< 50 mΩ
Insulation resistance:	> 100 MΩ at 500 V DC
Dielectric strength:	500 V, 50 Hz for the duration of 1 minute
Operating temperature:	- 20 °C to + 70 °C
Mechanical life:	minimum 2000 operations per pole
Material:	PBT meets UL 94 V-0
Contacts:	gold-plated over nickel
Construction:	case sealed; series DBP 2000 lever recessed
Mounting:	on pc-board
Slide position:	OFF
Soldering conditions:	auto-soldering – max.: 5 sec, 260 °C

Models:

Series DBP 2000

Type	Poles	Length (A)
DBP 2002	2	6,64 mm
DBP 2003	3	9,18 mm
DBP 2004	4	11,72 mm
DBP 2005	5	14,26 mm
DBP 2006	6	16,80 mm
DBP 2007	7	19,34 mm
DBP 2008	8	21,88 mm
DBP 2009	9	24,42 mm
DBP 2010	10	26,96 mm
DBP 2012	12	32,04 mm

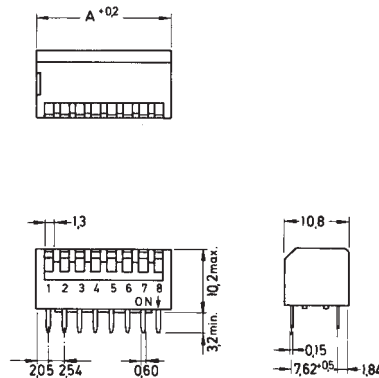

Series DBP 2100

Type	Poles	Length (A)
DBP 2102	2	6,64 mm
DBP 2103	3	9,18 mm
DBP 2104	4	11,72 mm
DBP 2105	5	14,26 mm
DBP 2106	6	16,80 mm
DBP 2107	7	19,34 mm
DBP 2108	8	21,88 mm
DBP 2109	9	24,42 mm
DBP 2110	10	26,96 mm
DBP 2112	12	32,04 mm

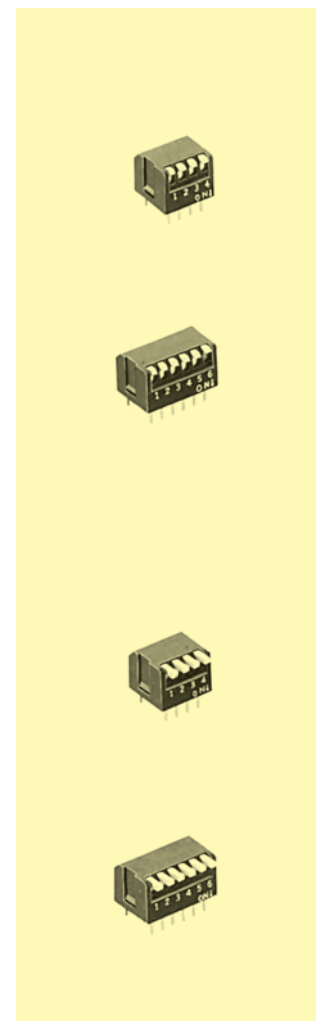
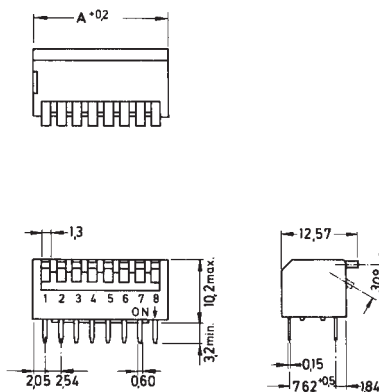

Dual-in-line Switches

Specifications:

Contact rating:	24 V DC, 25 mA
Contact resistance:	< 100 mΩ
Insulation resistance:	> 100 MΩ at 100 V DC
Dielectric strength:	500 V DC for 1 minute
Operating temperature:	- 20 °C C to + 70 °C
Mechanical life:	minimum 3000 operations per pole
Material:	PA 66/PBT, UL 94 V-0
Contacts:	phosphor bronze, gold-plated
Terminals:	phosphor bronze, tin-plated
Construction:	case sealed
Mounting:	on pc-board
Slide position:	OFF
Soldering conditions:	auto-soldering – max.: 10 sec., 260 °C

Models:

Series DBP 9100

Type	Poles	Length (A)
DBP 9102	2	6,08 mm
DBP 9103	3	8,62 mm
DBP 9104	4	11,16 mm
DBP 9105	5	13,70 mm
DBP 9106	6	16,24 mm
DBP 9108	8	21,32 mm
DBP 9110	10	26,40 mm

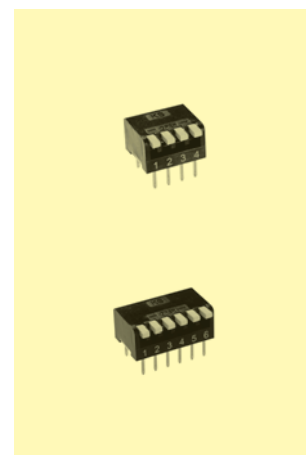
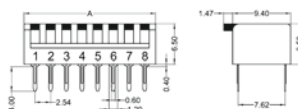

Packing: sticks

Type Stick

DBP 9102	85 pieces
DBP 9103	60 pieces
DBP 9104	46 pieces
DBP 9105	37 pieces
DBP 9106	31 pieces
DBP 9108	23 pieces
DBP 9110	20 pieces

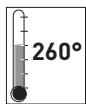

Dual-in-line Switches for SMT

Specifications:

Contact rating:	24 V DC, 25 mA
Contact resistance:	100 mΩ
Insulation resistance:	1000 MΩ at 100 V DC
Dielectric strength:	500 V DC for 1 minute
Operating temperature:	- 20 °C to + 70 °C
Mechanical life:	minimum 3000 operations per pole
Material:	PA66/PBT, UL 94 V-0
Contacts:	copper alloy, gold-plated
Terminals:	copper alloy, tin-plated
Construction:	case sealed
Mounting:	on pc-board – SMD
Slide position:	OFF

Models:

Series SBP 9100 T

Type	Poles	Length (A)
SBP 9102 T	2	6,08 mm
SBP 9103 T	3	8,62 mm
SBP 9104 T	4	11,16 mm
SBP 9105 T	5	13,70 mm
SBP 9106 T	6	16,24 mm
SBP 9108 T	8	21,32 mm
SBP 9110 T	10	26,40 mm
SBP 9112 T	12	31,48 mm

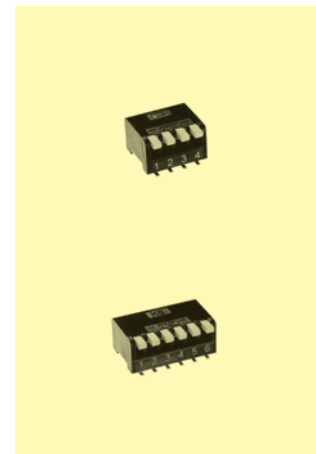
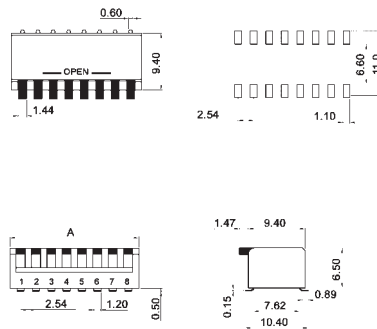



Packing: on tapes

Models	Tape	Reel	Tape width (A)
SBP 9102 T	700 pieces;	Ø 330 mm	24,0 mm
SBP 9103 T	500 pieces;	Ø 330 mm	24,0 mm
SBP 9104 T	500 pieces;	Ø 330 mm	24,0 mm
SBP 9105 T	500 pieces;	Ø 330 mm	24,0 mm
SBP 9106 T	500 pieces;	Ø 330 mm	24,0 mm
SBP 9108 T	500 pieces;	Ø 330 mm	44,0 mm
SBP 9110 T	500 pieces;	Ø 330 mm	44,0 mm
SBP 9112 T	500 pieces;	Ø 330 mm	44,0 mm

6

Rotary Coded Switches

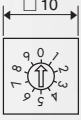
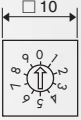
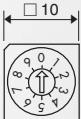
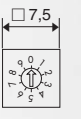
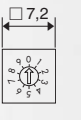

Series	Size / Foot print	Shaft		Mounting					Page
		w	w.O.	stan- dard	right angle	front- panel	SMT	IP67	
DRS 3000/4000 DRR 3000/4000 SMR 5000		•	•	•					154 154 155
DRS 20 000/21 000 DRR 20 000/21 000 SMR 20 000		•	•	•					156 156 157
DRS/DRR/SMR 60 000/61 000		•	•	•	•			•	158 159
DRS 7000/8000 DRR 7000/8000 SMR 7000-1/8000-1 SMRR 7000-1/8000-1		•	•	•					160 160 161 161
DRS 13 000/14 000 SMR 13 000/14 000		•	•	•				•	162 163
DRS 15 000/16 000 SMR 15 000/16 000		•	•	•				•	164 165
DRS 20		•		•			•		166

All types available with the codes BCD, Hexadecimal, BCD inverse, Hexadecimal inverse.

Subminiature Rotary Coded Switches



Specifications:

Contact rating:	50 V DC, 100 mA, non switching 15 V DC, 30 mA, switching
Contact resistance:	< 100 mΩ
Insulation resistance:	> 1000 MΩ at 250 V DC
Dielectric strength:	250 V, 50 Hz for the duration of 1 minute
Operating temperature:	- 40 °C to +85 °C
Mechanical life:	minimum 20 000 operations
Contacts:	gold-plated
Terminals:	PC terminals, phosphor bronze, gold-plated
Case material:	PBT black, rotor: standard types yellow; inverse types red
Construction:	case totally sealed, suitable for washing by immersion
Mounting:	on pc-board
Soldering conditions:	auto-soldering – max.: 6 sec, 275 °C

washable

Models:	Code
DRS 3010	BCD
DRS 3110	BCD Inverse
DRS 3016	Hexadecimal
DRS 3116	Hexadecimal Inverse

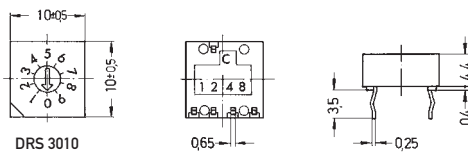

DRS 4010	BCD
DRS 4110	BCD Inverse
DRS 4016	Hexadecimal
DRS 4116	Hexadecimal Inverse

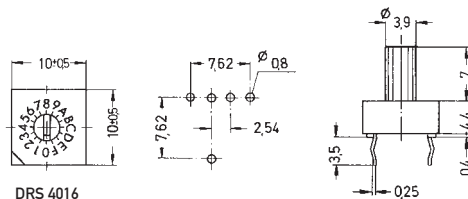

DRR 3010	BCD
DRR 3110	BCD Inverse
DRR 3016	Hexadecimal
DRR 3116	Hexadecimal Inverse

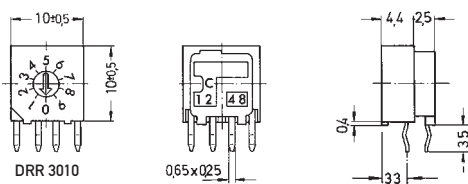

DRR 4010	BCD
DRR 4110	BCD Inverse
DRR 4016	Hexadecimal
DRR 4116	Hexadecimal Inverse

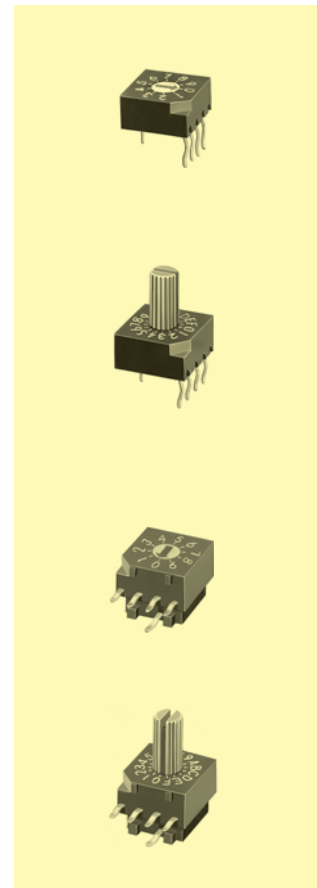
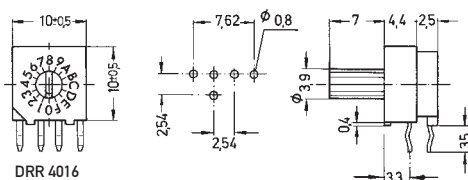

Accessories:

Caps

yellow	KR 108
red	KR 109
white	KR 110

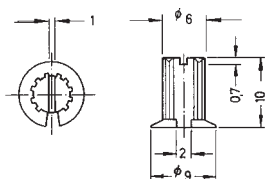

grey KR 207

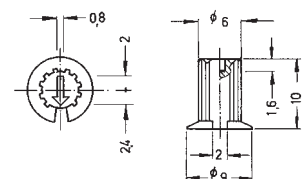

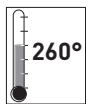

Subminiature Rotary Coded Switches for SMT

Specifications:

Contact rating:	50 V DC, 100 mA, non switching 15 V DC, 30 mA, switching
Contact resistance:	< 100 mΩ
Insulation resistance:	> 1000 MΩ at 250 V DC
Dielectric strength:	250 V, 50 Hz for the duration of 1 minute
Operating temperature:	- 40 °C to + 85 °C
Mechanical life:	minimum 20 000 operations
Contacts:	phosphor bronze, gold-plated
Terminals:	phosphor bronze, gold-plated
Case material:	PPS black, rotor: standard types yellow; inverse types red
Construction:	case totally sealed with protective tape
Mounting:	on pc-board – SMD

washable

Models:	Code
SMR 5010	BCD
SMR 5110	BCD Inverse

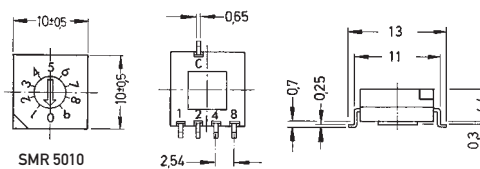

SMR 5016	Hexadecimal
SMR 5116	Hexadecimal Inverse

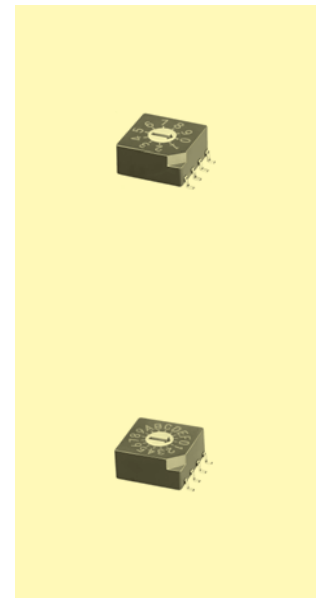
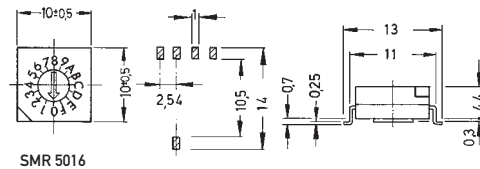

Packing: on tapes
for order on tape: additional to type number: T
example of order: SMR 5010 T

Tape 500 pieces Reel ∅ 330 mm

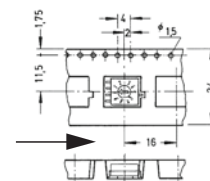

Subminiature Rotary Coded Switches



Specifications:

Contact rating:	24 V DC, 25 mA switching
Contact resistance:	< 100 mΩ
Insulation resistance:	> 1000 MΩ
Dielectric strength:	250 V, 50 Hz for the duration of 1 minute
Operating temperature:	- 25 °C to + 70 °C
Mechanical life:	minimum 2000 operations
Terminals:	phosphor bronze, gold-plated over nickel barrier
Material:	case: PBT blue, meets UL 94 V-0, washable, rotor: white; inverse type red
Mounting:	on pc-board
Soldering conditions:	auto-soldering – max.: 5 sec, 260 °C

Models: Code

DRS 20010	BCD				
DRS 20110	BCD Inverse				
DRS 20016	Hexadecimal				
DRS 20116	Hexadecimal Inverse				
DRS 21010	BCD				
DRS 21110	BCD Inverse				
DRS 21016	Hexadecimal				
DRS 21116	Hexadecimal Inverse				
DRR 20010	BCD				
DRR 20110	BCD Inverse				
DRR 20016	Hexadecimal				
DRR 20116	Hexadecimal Inverse				
DRR 21010	BCD				
DRR 21110	BCD Inverse				
DRR 21016	Hexadecimal				
DRR 21116	Hexadecimal Inverse				

Special version:

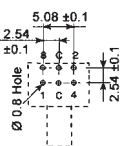

Spacing 2,54 mm
 Additional to type number: -1
 Example of order: DRR 20010-1

washable

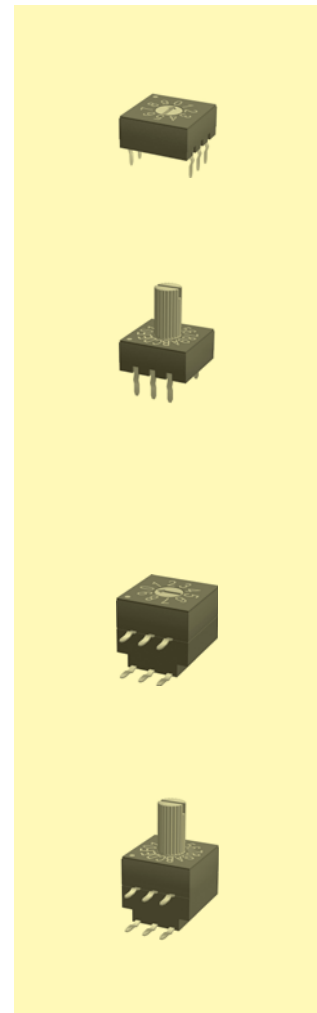

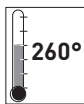

Subminiature Rotary Coded Switches for SMT

Specifications:

Contact rating:	24 V DC, 25 mA switching
Contact resistance:	< 100 mΩ
Insulation resistance:	> 1000 MΩ
Dielectric strength:	250 V, 50 Hz for the duration of 1 minute
Operating temperature:	- 25 °C to + 70 °C
Mechanical life:	minimum 2000 operations
Terminals:	phosphor bronze, gold-plated over nickel barrier
Material:	case: PBT black, meets UL 94 V-0, washable, rotor: white; inverse type red
Mounting:	on pc-board

washable

Models: Code

SMR 20010	BCD
SMR 20110	BCD Inverse

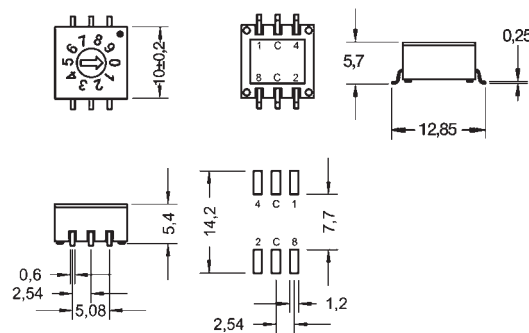

SMR 20016	Hexadecimal
SMR 20116	Hexadecimal Inverse

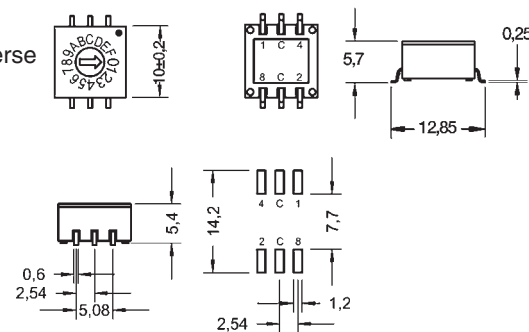

Packing: 700 pieces per reel

Subminiature Rotary Coded Switches waterproof



Specifications:

Contact rating:	24 V DC, 25 mA switching
Contact resistance:	< 80 mΩ
Insulation resistance:	> 100 MΩ
Dielectric strength:	250 V, 50 Hz for the duration of 1 minute
Operating temperature:	-20 °C to +70 °C
Storage temperature:	-40 °C to +85 °C
Mechanical life:	minimum 10 000 operations
Terminals:	phosphor bronze, gold-plated over nickel barrier
Material:	case: PA6T meets UL 94 V-0, cover light grey, base black rotor: grey, inverse type beige
Protection:	IP 67
Mounting:	on pc-board with spacing 2,54 mm
Soldering conditions:	auto-soldering – max.: 5 sec, 260 °C

Models: Code

DRS 60010	BCD
DRS 60110	BCD Inverse
DRS 60016	Hexadecimal
DRS 60116	Hexadecimal Inverse

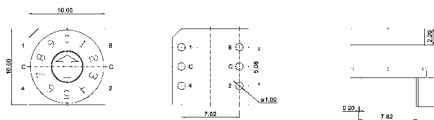

DRS 61010	BCD
DRS 61110	BCD Inverse
DRS 61016	Hexadecimal
DRS 61116	Hexadecimal Inverse

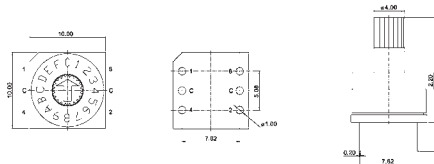

DRR 60010	BCD
DRR 60110	BCD Inverse
DRR 60016	Hexadecimal
DRR 60116	Hexadecimal Inverse

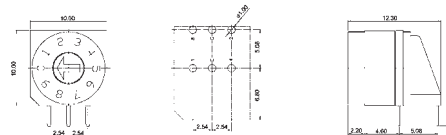

Special version:

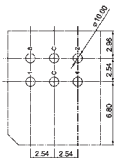

Spacing 2,54 mm

Additional to type number: -1

Example for order: DRR 60010-1

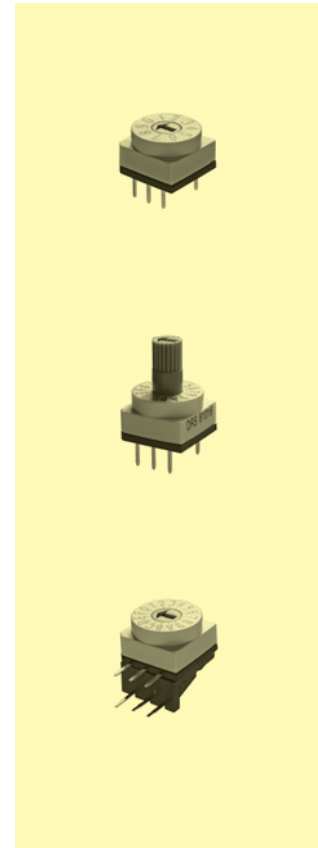

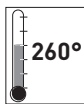

Subminiature Rotary Coded Switches for SMT, waterproof

Specifications:

Contact rating:	24 V DC, 25 mA switching
Contact resistance:	<80 mΩ
Insulation resistance:	> 100 MΩ
Dielectric strength:	250 V, 50 Hz for the duration of 1 minute
Operating temperature:	-20 °C to +70 °C
Storage temperature:	-40 °C to +85 °C
Mechanical life:	minimum 10 000 operations
Terminals:	phosphor bronze, gold-plated over nickel barrier
Material:	case: PA6T grey meets UL 94 V-0 rotor: PA 66 grey, inverse type blue
Protection:	IP 67
Mounting:	on pc-board
Packing:	600 pcs/reel

Models: Code

SMR 60010	BCD
SMR 60110	BCD Inverse
SMR 60016	Hexadecimal
SMR 60116	Hexadecimal Inverse

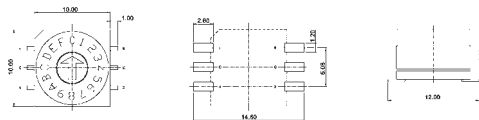

SMR 61010	BCD
SMR 61110	BCD Inverse
SMR 61016	Hexadecimal
SMR 61116	Hexadecimal Inverse

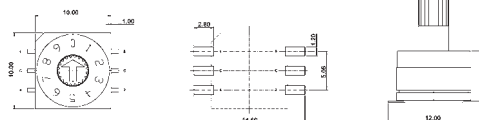

washable

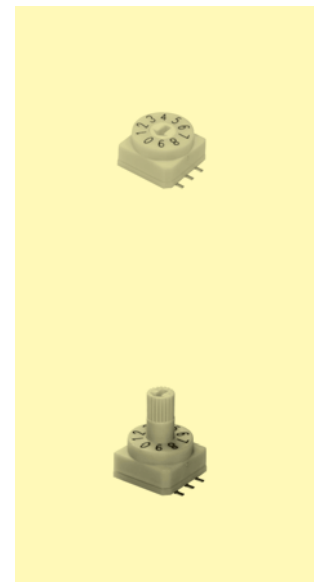

Special versions on request

Microminiature Rotary Coded Switches



Specifications:

Contact rating:	50 V DC, 100 mA, non-switching 15 V DC, 30 mA, switching
Contact resistance:	< 200 mΩ
Insulation resistance:	> 1000 MΩ at 250 V DC
Dielectric strength:	250 V, 50 Hz for the duration of 1 minute
Operating temperature:	- 25 °C to +85 °C
Mechanical life:	minimum 20 000 operations
Contacts:	gold-plated
Terminals:	PC terminals, phosphor bronze, gold-plated
Material:	case: PPS, black frame: stainless steel rotor: PA, standard types yellow; inverse types red
Construction:	case totally sealed, suitable for washing by immersion
Mounting:	on pc-board
Soldering conditions:	auto-soldering – max.: 6 sec, 260 °C

washable

Models: Code

DRS 7010	BCD
DRS 7110	BCD Inverse
DRS 7016	Hexadecimal
DRS 7116	Hexadecimal Inverse

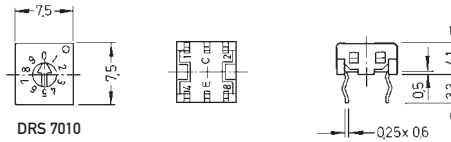

DRS 8010	BCD
DRS 8110	BCD Inverse
DRS 8016	Hexadecimal
DRS 8116	Hexadecimal Inverse

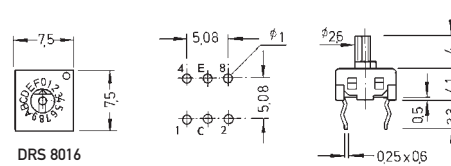

DRR 7010	BCD
DRR 7110	BCD Inverse
DRR 7016	Hexadecimal
DRR 7116	Hexadecimal Inverse

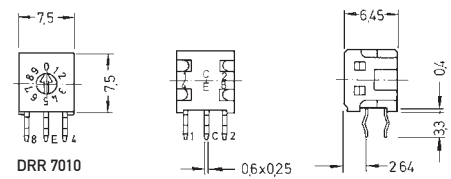

DRR 8010	BCD
DRR 8110	BCD Inverse
DRR 8016	Hexadecimal
DRR 8116	Hexadecimal Inverse

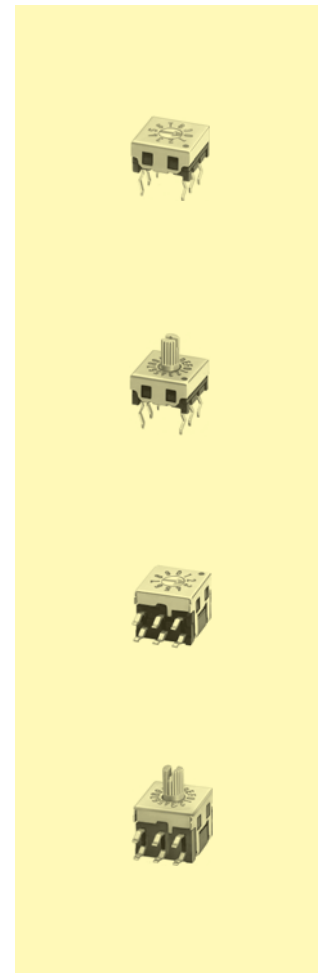
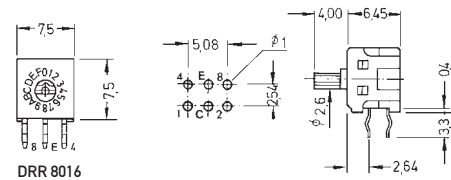

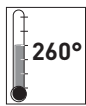

Microminiature Rotary Coded Switches for SMT

Specifications:

Contact rating:	50 V DC, 100 mA, non-switching 15 V DC, 30 mA, switching
Contact resistance:	< 200 mΩ
Insulation resistance:	> 1000 MΩ at 250 V DC
Dielectric strength:	250 V, 50 Hz for the duration of 1 minute
Operating temperature:	-25 °C to +85 °C
Mechanical life:	minimum 20 000 operations
Contacts:	gold-plated
Terminals:	phosphor bronze, gold-plated
Material:	case: PPS, black; frame: stainless steel rotor: PA, standard types yellow; inverse types red
Construction:	case totally sealed, suitable for washing by immersion
Mounting:	on pc-board – SMD

washable

Models: Code

SMR 7010-1	BCD
SMR 7110-1	BCD Inverse
SMR 7016-1	Hexadecimal
SMR 7116-1	Hexadecimal Inverse

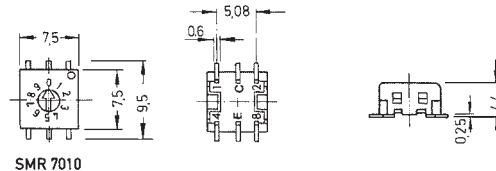

SMR 8010-1	BCD
SMR 8110-1	BCD Inverse
SMR 8016-1	Hexadecimal
SMR 8116-1	Hexadecimal Inverse

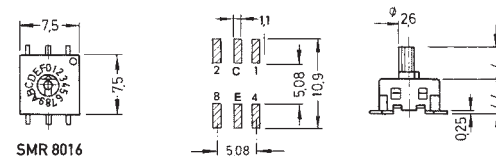

SMRR 7010-1	BCD
SMRR 7110-1	BCD Inverse
SMRR 7016-1	Hexadecimal
SMRR 7116-1	Hexadecimal Inverse

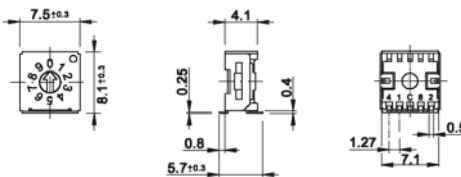

SMRR 8010-1	BCD
SMRR 8110-1	BCD Inverse
SMRR 8016-1	Hexadecimal
SMRR 8116-1	Hexadecimal Inverse

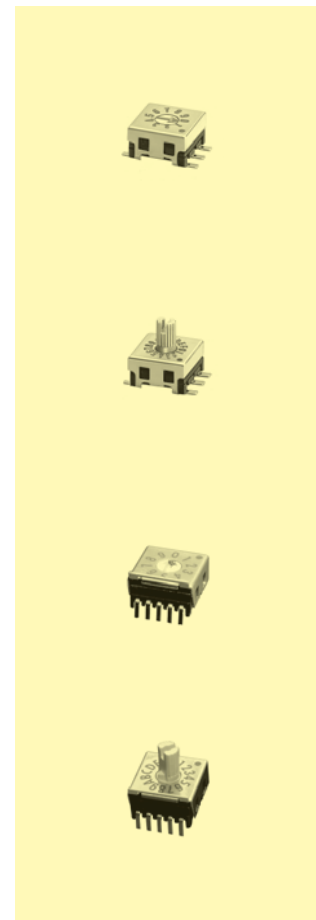
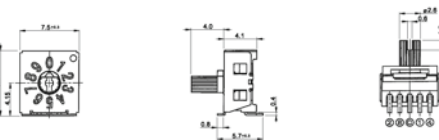

Packing: sticks or tapes
for order on tape: additional to type number: T
example of order: SMR 7010-1 T

Models	Stick	Tape	Reel
SMR	50 pieces; L 450 mm	1000 pieces	∅ 330 mm
SMRR	50 pieces; L 435 mm	500 pieces	∅ 330 mm

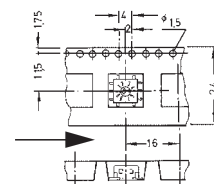

Microminiature Rotary Coded Switches



Specifications:

Contact rating:	50 V DC, 100 mA, non-switching 5 V DC, 100 mA, switching
Contact resistance:	< 200 mΩ
Insulation resistance:	> 1000 MΩ
Dielectric strength:	250 V, 50 Hz for the duration of 1 minute
Operating temperature:	- 25 °C to + 75 °C
Mechanical life:	minimum 10 000 operations
Contacts:	gold-plated
Terminals:	PC terminals, phosphor bronze, gold-plated
Case material:	thermoplastic; rotor: standard types ivory; inverse types red
Construction:	case totally sealed, suitable for washing by immersion
Mounting:	on pc-board
Soldering conditions:	auto-soldering – max.: 3 sec, 250 °C

Models:	Code
DRS 13010	BCD
DRS 13110	BCD Inverse
DRS 13016	Hexadecimal
DRS 13116	Hexadecimal Inverse

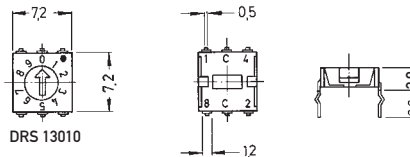

DRS 14010	BCD
DRS 14110	BCD Inverse
DRS 14016	Hexadecimal
DRS 14116	Hexadecimal Inverse

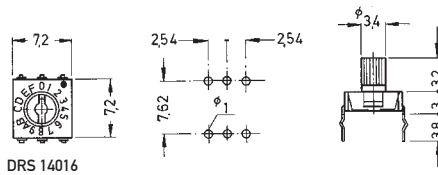

washable

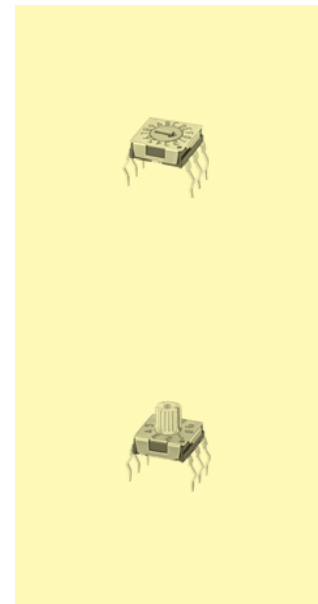

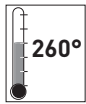

Microminiature Rotary Coded Switches for SMT

Specifications:

Contact rating:	50 V DC, 100 mA, non-switching 5 V DC, 100 mA, switching
Contact resistance:	< 200 mΩ
Insulation resistance:	> 1000 MΩ at 100 V DC
Dielectric strength:	250 V, 50 Hz for the duration of 1 minute
Operating temperature:	- 25 °C to + 75 °C
Mechanical life:	minimum 20 000 operations
Contacts:	phosphor bronze, gold-plated
Material:	case: LCP; frame: stainless steel rotor: PA, standard types ivory; inverse types red
Construction:	case totally sealed, suitable for washing by immersion
Mounting:	on pc-board – SMD
Soldering conditions:	reflow-soldering

washable

Models:

Code

SMR 13010	BCD
SMR 13110	BCD Inverse
SMR 13016	Hexadecimal
SMR 13116	Hexadecimal Inverse

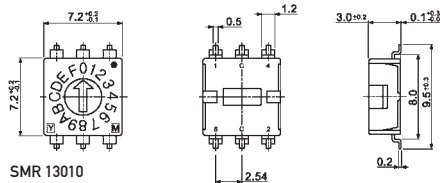

SMR 14010	BCD
SMR 14110	BCD Inverse
SMR 14016	Hexadecimal
SMR 14116	Hexadecimal Inverse

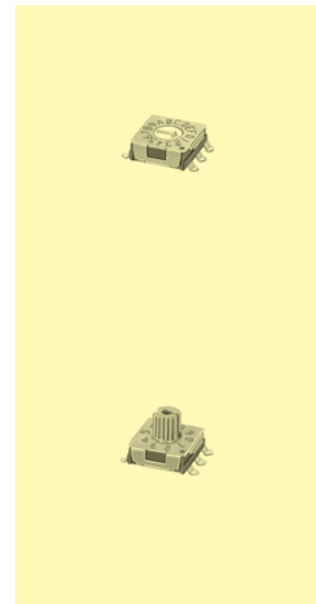
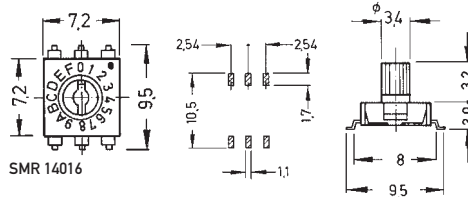

Packing:

sticks or tapes
for order on tapes: additional to type number: T
example of order: SMR 13010 T

Models

Models	Stick	Tape	Reel
SMR 13 000	65 pieces; L 510 mm	1000 pieces	∅ 330 mm
SMR 14 000	65 pieces; L 510 mm	–	–

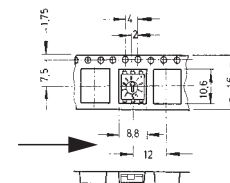

Microminiature Rotary Coded Switches waterproof

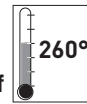

Specifications:

Contact rating:	42 V DC, 400 mA non-switching 42 V DC, 100 mA switching
Contact resistance:	< 80 mΩ
Insulation resistance:	>100 MΩ at 250 V DC for 1 minute ± 5 sec.
Dielectric strength:	250 V (50/60 Hz) for 1 minute
Operating temperature:	-50 °C to +125 °C
Storage temperature:	-55 °C to +135 °C
Mechanical life:	minimum 25 000 cycles
Material:	Cover/spring plate/guide plate: stainless steel Contact/terminal: phosphor bronze, >0,07 μm gold-plated over >0,3 μm nickel Rotor/base: PA66 O-ring: silicone
Actuator colour:	BCD real: pink; BCD inverse: orange; Hex real: grey; Hex inverse: ivory
Protection:	IP 67
Operating force:	120 ± 30 gf/cm
Soldering conditions:	auto-soldering – max.: 260 °C ± 5 °C, 5 ± 1 sec., IR reflow soldering

washable

Models: Code

DRS 15010	BCD
DRS 15110	BCD Inverse
DRS 15016	Hexadecimal
DRS 15116	Hexadecimal Inverse

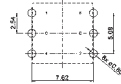
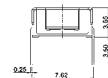
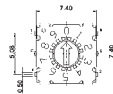

DRS 16010	BCD
DRS 16110	BCD Inverse
DRS 16016	Hexadecimal
DRS 16116	Hexadecimal Inverse

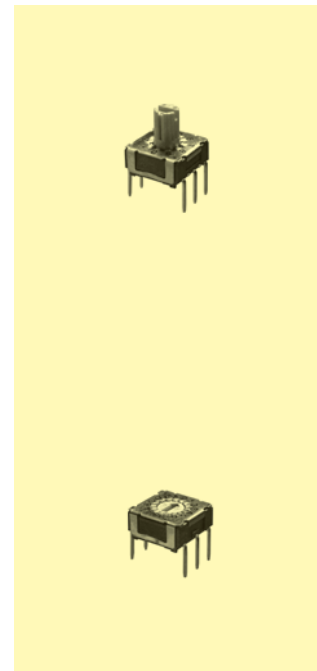
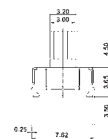
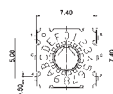

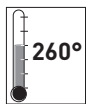

Microminiature Rotary Coded Switches for SMT

Specifications:

Contact rating:	42 V DC, 400 mA non-switching 42 V DC, 100 mA switching
Contact resistance:	< 80 mΩ
Insulation resistance:	>100 MΩ at 250 V DC for 1 minute ± 5 sec.
Dielectric strength:	250 V (50/60 Hz) for 1 minute
Operating temperature:	-50 °C to +125 °C
Storage temperature:	-55 °C to +135 °C
Mechanical life:	minimum 25 000 cycles
Material:	Cover/spring plate/guide plate: stainless steel Contact/terminal: phosphor bronze, >0,07 μm gold-plated over >0,3 μm nickel Rotor/base: PA66 O-ring: silicone
Actuator colour:	BCD real: pink; BCD inverse: orange; Hex real: grey; Hex inverse: ivory
Protection:	IP 67
Operating force:	120 ± 30 gf/cm

Models:	Code
SMR 15010	BCD
SMR 15110	BCD Inverse
SMR 15016	Hexadecimal
SMR 15116	Hexadecimal Inverse

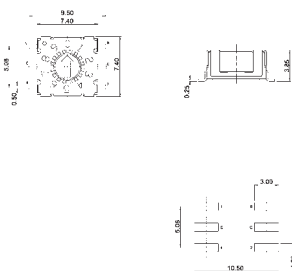

SMR 16010	BCD
SMR 16110	BCD Inverse
SMR 16016	Hexadecimal
SMR 16116	Hexadecimal Inverse

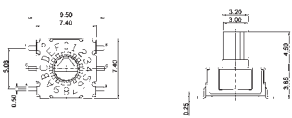

washable

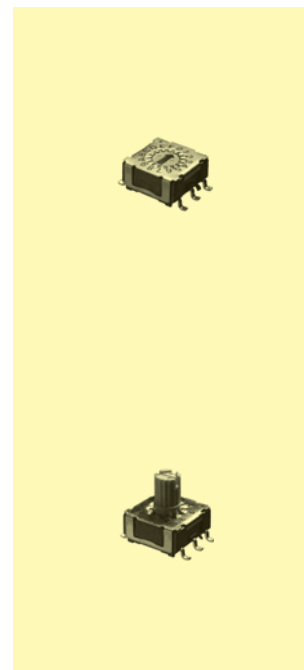

6

Packing:

SMR 15	<input type="checkbox"/> <input type="checkbox"/>	1300 pieces/reel
SMR 16	<input type="checkbox"/> <input type="checkbox"/>	600 pieces/reel

Miniature Rotary Coded Switches

Specifications:

Contact rating:	15 V DC, 100 mA
Contact resistance:	< 50 mΩ
Insulation resistance:	> 100 MΩ at 500 V DC
Dielectric strength:	250 V, 50 Hz for the duration of 1 minute
Operating temperature:	- 20 °C to + 80 °C
Mechanical life:	minimum 10 000 operations
Contacts:	combination of silver- and gold-plated
Material:	case: PBT with glass fibre 30%; shaft: aluminium
Mounting:	on pc-board or front panel, bushing M 9 x 0,75, key 12 mm
Soldering conditions:	max.: 3 sec, 230 °C ± 5 °C

Models: DRS 20

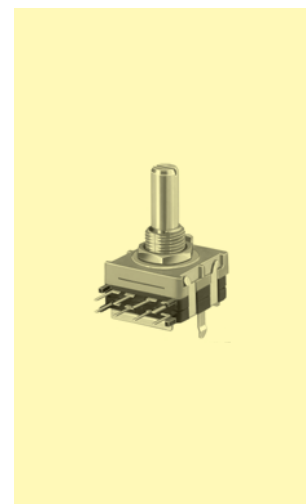
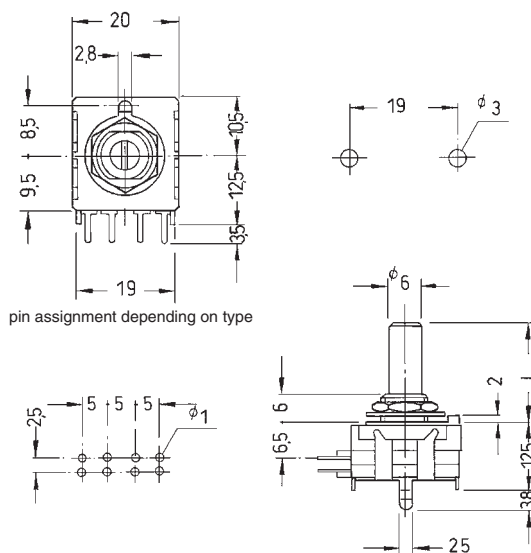

Ordering code:

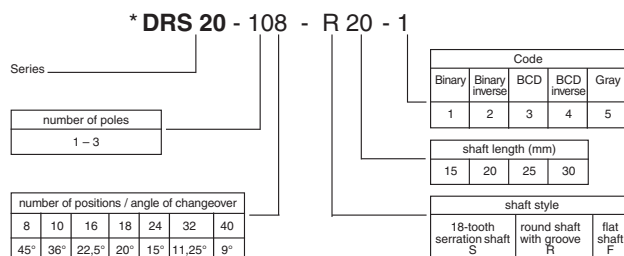

* Non-stock item; minimum quantity and delivery time on request



BCD

	0	1	2	3	4	5	6	7	8	9
8									X	X
4					X	X	X	X	X	
2			X	X		X	X	X		
1		X		X		X		X		X

Hexadecimal

	0	1	2	3	4	5	6	7	8	9	A	B	C	D	E	F
8									X	X	X	X	X	X	X	X
4					X	X	X	X			X	X	X	X	X	X
2			X	X		X	X				X	X				
1		X		X		X		X		X			X		X	

BCD Inverse

	0	1	2	3	4	5	6	7	8	9
$\bar{8}$	X	X	X	X	X	X	X	X		
$\bar{4}$	X	X	X	X					X	X
$\bar{2}$	X	X			X	X			X	X
$\bar{1}$	X		X		X		X		X	

Hexadecimal Inverse

	0	1	2	3	4	5	6	7	8	9	A	B	C	D	E	F
$\bar{8}$	X	X	X	X	X	X	X	X								
$\bar{4}$	X	X	X	X					X	X	X					
$\bar{2}$	X	X			X	X			X	X		X	X			
$\bar{1}$	X		X		X		X		X		X		X		X	

7

Rotary Switches

7.1 Miniature Rotary Switches



Series MR

170

Series MRS

171–174

7.2 Microminiature Rotary Switches



Series SMR

175

7.3 Key Switches



Series MRK

176–177

Miniature Rotary Switches

Specifications:

Contact rating:	step angle between 2 positions 30°: 125 V AC, 0,15 24 V DC, 0,15 A
	step angle between 2 positions 36°: 125 V AC, 0,5 A 24 V DC, 0,5 A
Contact resistance:	< 10 mΩ
Insulation resistance:	> 100 MΩ at 500 V DC
Dielectric strength:	1000 V, 50 Hz for the duration of 1 minute
Humidity resistance:	10 MΩ after 48 h at 40° C and 95 % relative humidity
Operating temperature:	- 45 °C to + 110 °C
Electrical life:	10 000 – 30 000 operations depending on load
Contacts:	coin silver
Material:	body: diallyl-phthalate, cover: aluminium shaft: brass, nickel-plated
Contact timing:	non-shorting
Mounting:	bushing 1/4" with locking plate or flat bush – 40 THD, key 8 mm axis 1/8"

Models:	Poles	Positions
MR 1 – 10*	1	10
MR 1 – 10 C	1	10
MR 2 – 5*	2	5
MR 3 – 3*	3	3
MR 4 – 2	4	2

C = without stopper

* On MR switches, the number of positions can be reduced by changing the positions of the inner ring. For using all positions, this ring has to be removed.

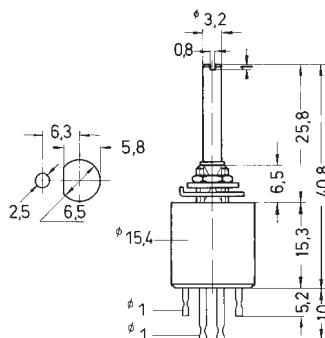

Angle between 2 positions 36°

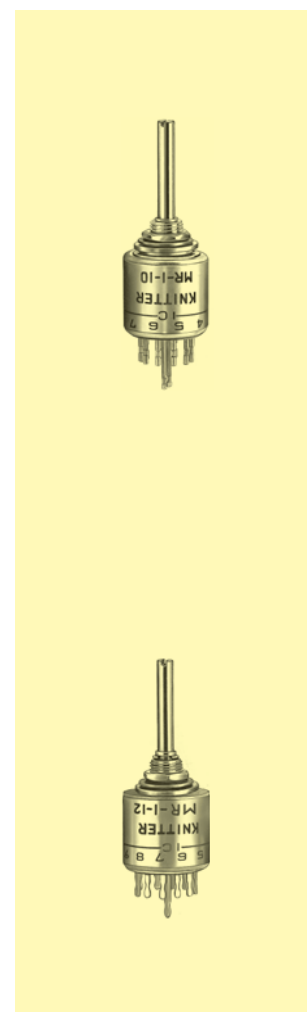

MR 1 – 12*	1	12
MR 2 – 6	2	6
MR 3 – 4	3	4
MR 4 – 3	4	3

* without stopper

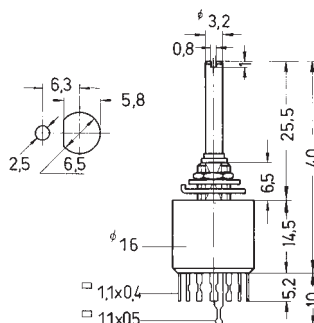

Angle between 2 positions 30°



Miniature Rotary Switches

Specifications:

Contact rating:	16 V DC, 300 mA
Contact resistance:	< 50 mΩ
Insulation resistance:	> 100 MΩ at 500 V DC
Dielectric strength:	100 V, 50 Hz for the duration of 1 minute
Operating temperature:	- 20 °C to + 80 °C
Mechanical life:	minimum 10 000 operations
Contacts:	gold
Material:	case: PBT with glass fibre 30%; shaft: PA, flat
Angle between 2 positions:	30°
Mounting:	on pc-board or front panel, bushing M 9 x 0,75, key 12 mm
Contact timing:	non-shorting
Soldering conditions:	max.: 3 sec, 260 °C

Models:

MRS 18 V

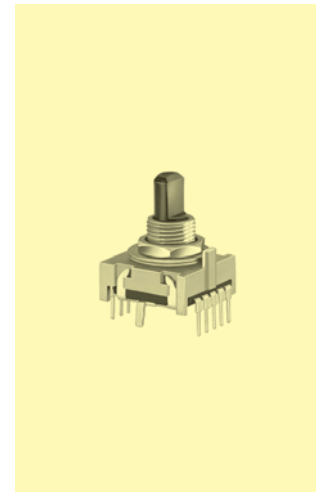
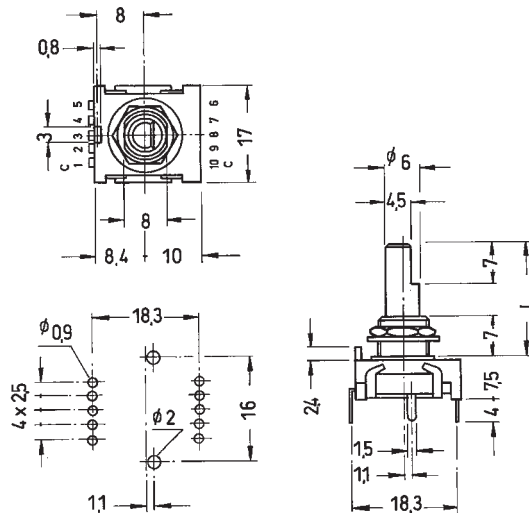

Circuit diagram:

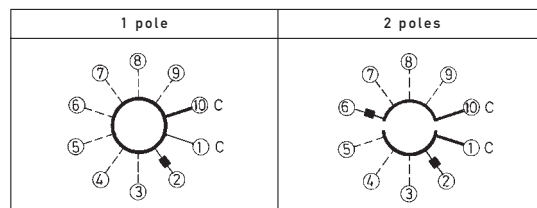

Ordering code:

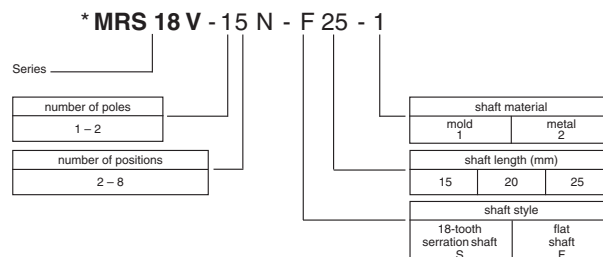

* Non-stock item; minimum quantity and delivery time on request



Miniature Rotary Switches

Specifications:

Contact rating:	16 V DC, 100 mA
Contact resistance:	< 50 mΩ
Insulation resistance:	> 100 MΩ at 500 V DC
Dielectric strength:	500 V, 50 Hz for the duration of 1 minute
Operating temperature:	- 20 °C to + 80 °C
Mechanical life:	minimum 10 000 operations
Contacts:	gold-plated
Material:	case: PBT with glass fibre 30%; shaft: aluminium
Angle between 2 positions:	30°
Mounting:	on pc-board or front panel, bushing M 7 x 0,75, key 10 mm
Soldering conditions:	max.: 3 sec, 230 °C ± 5 °C

Models:

MRS 10 H

Measure A:
 1 section 12,0 mm
 2 sections 19,5 mm
 3 sections 27,0 mm

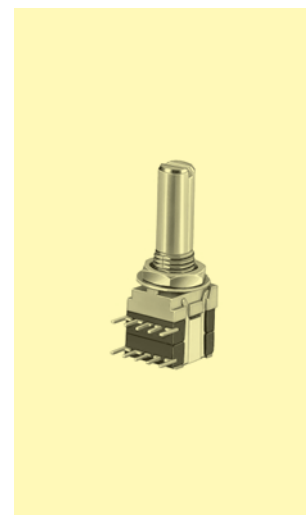
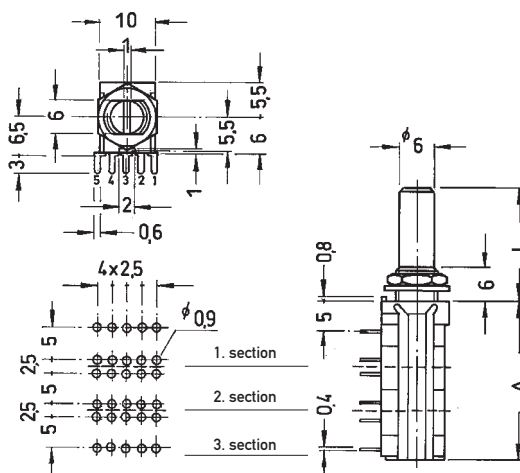

Circuit diagram:

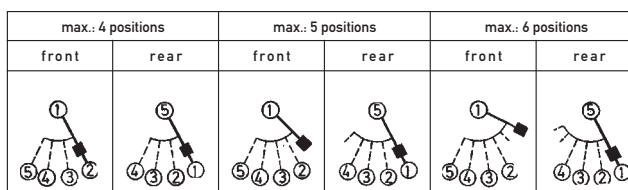

Ordering code:

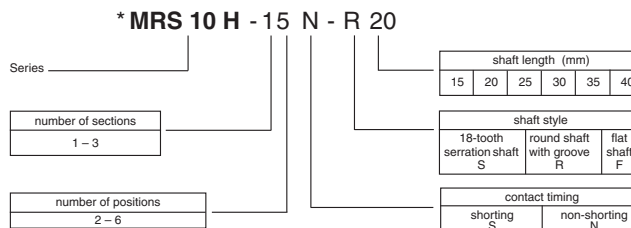

* Non-stock item; minimum quantity and delivery time on request.



Miniature Rotary Switches

Specifications:

Contact rating:	16 V DC, 100 mA
Contact resistance:	< 50 mΩ
Insulation resistance:	> 100 MΩ at 500 V DC
Dielectric strength:	100 V, 50 Hz for the duration of 1 minute
Operating temperature:	- 20 °C to + 80 °C
Mechanical life:	minimum 10 000 operations
Contacts:	gold
Material:	case: PBT with glass fibre 30%; shaft: PA, flat
Angle between 2 positions:	40°, 9 positions
Mounting:	on pc-board
Contact timing:	non-shorting
Soldering conditions:	max.: 3 sec, 260 °C
Operating force:	250 ± 100 gf. cm

Models:	Poles
MRS 12 V – 19	1

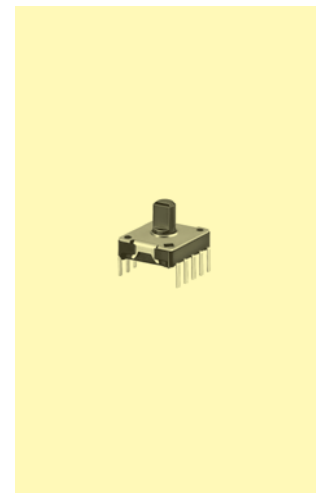
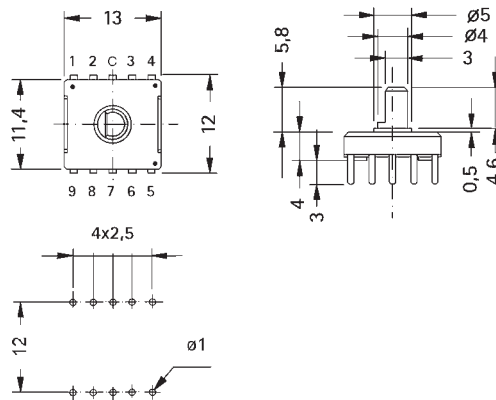

Circuit diagram:

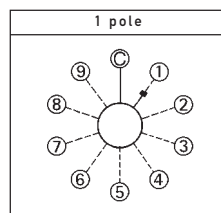

Miniature Rotary Switches waterproof



Specifications:

Contact rating:	50 V DC, 100 mA non-switching 5 V DC, 100 mA switching
Contact resistance:	< 100 mΩ
Insulation resistance:	> 100 MΩ
Dielectric strength:	300 V, 50 Hz for the duration of 1 minute
Operating temperature:	-40 °C to +85 °C
Mechanical life:	minimum 20 000 steps
Material:	Surface of contacts: gold Surface of terminals: tin Rotor/Base: PA 66
Ingress Protection:	IP 67
Angle between 2 positions:	45°
Mounting:	on pc-board
Contact timing:	non-shorting
Soldering conditions:	auto-soldering – max.: 6 sec, 260 °C

Models:

MRS 8140

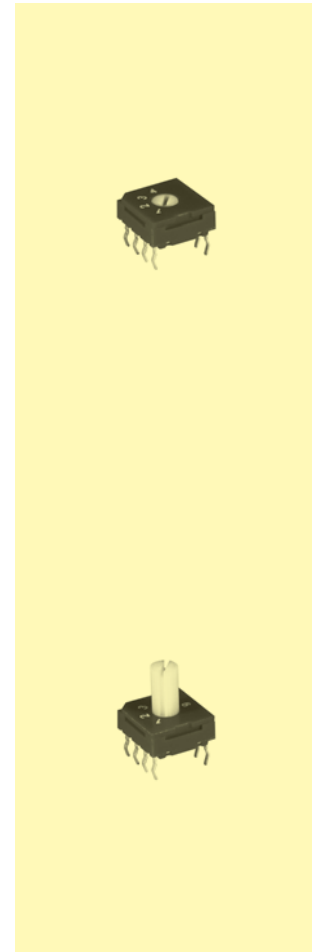
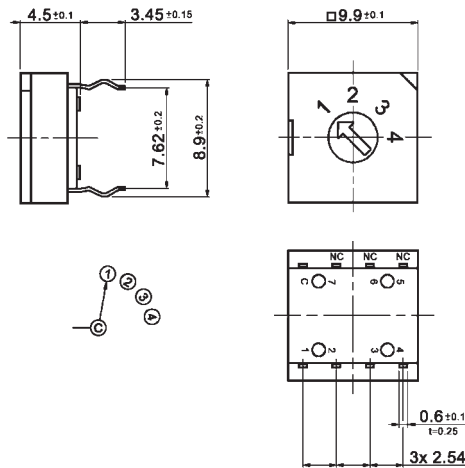

MRS 8167

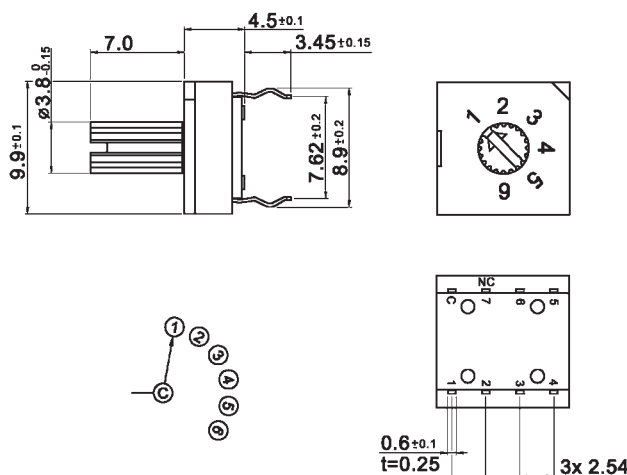

7



Microminiature Rotary Switches for SMT

Specifications:

Contact rating:	12 V DC, 50 mA min. 20 mV DC / 5 mA
Contact resistance:	< 100 mΩ
Insulation resistance:	> 50 000 MΩ
Dielectric strength:	500 V, 50 Hz for the duration of 1 minute
Operating temperature:	- 30 °C to + 85 °C
Mechanical life:	minimum 800 operations
Contacts:	gold-plated over nickel barrier
Terminals:	gold-plated over nickel barrier
Material:	case: PPS thermoplastic meets UL 94 V-0, washable frame: stainless steel
Mounting:	on pc-board – SMD
Soldering conditions:	reflow-soldering – max.: 10 sec ±1 sec, 250 °C ± 10 °C

washable

Models:

Switching functions

SMR 1–30

on – on

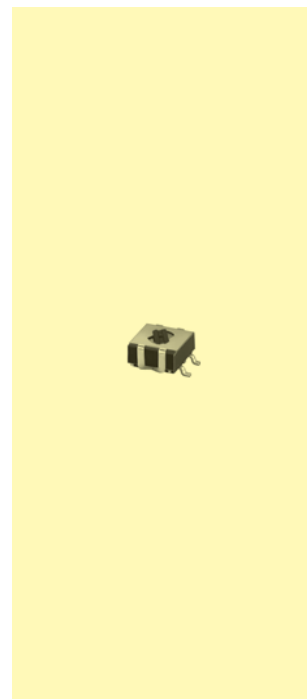
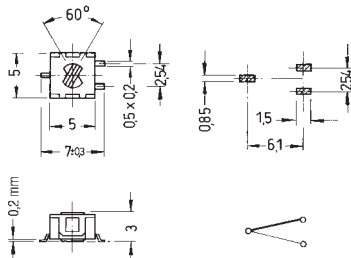

Packing:

on tapes: 2500 pieces; reel Ø 333 mm

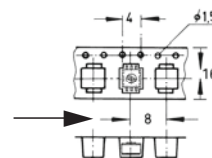

Key Switches



Specifications:

Contact rating:	max. 20 V DC, 0,4 W
Contact resistance:	< 200 mΩ
Insulation resistance:	> 100 MΩ at 100 V DC
Dielectric strength:	250 V, 50 Hz for the duration of 1 minute
Operating temperature:	- 25 °C to + 70 °C
Mechanical life:	minimum 10 000 operations
Contacts:	gold-plated
Terminals:	PC terminals, brass, silver-plated
Material:	case: PBT, black key: brass, nickel-plated; grip: plastic
Mounting:	on pc-board
Soldering conditions:	auto-soldering – max.: 3 sec, 245 °C ± 10 °C

Models:

Switching functions

Key positions

I II III

S P D T

O = Key removable

X = Key not removable

Step angle 90°

MRK 1012 A	on	–	on	O	O
MRK 1012 B	on	–	on	O	X
MRK 1022 B	on	–	mom	O	X
MRK 1012 A – R	on	–	on	O	O
MRK 1012 B – R	on	–	on	O	X
MRK 1022 B – R	on	–	mom	O	X

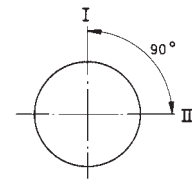

7

Step angle 45°

MRK 1031 D	on	on	on	O	O	O
MRK 1031 L	on	on	on	X	O	X
MRK 1041 L	mom	on	mom	X	O	X
MRK 1031 D – R	on	on	on	O	O	O
MRK 1031 L – R	on	on	on	X	O	X
MRK 1041 L – R	mom	on	mom	X	O	X

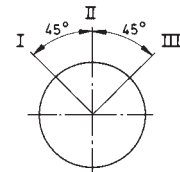

2-pole switches and further key positions on request.

Switches are always supplied with 2 keys.

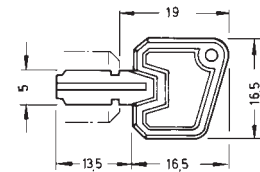

Key Switches



Models:

SPDT

Step angle 90°

- MRK 1012 A
- MRK 1012 B
- MRK 1022 B

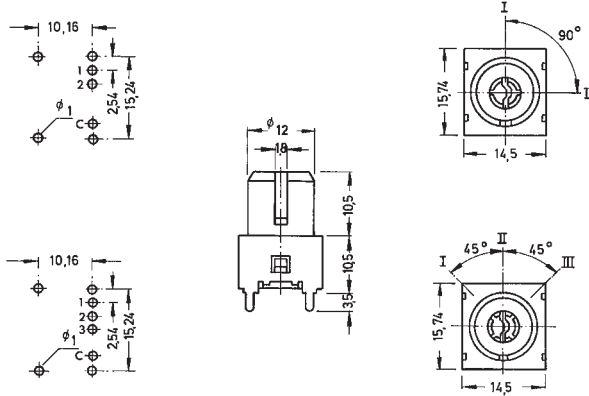

Step angle 45°

- MRK 1031 D
- MRK 1031 L
- MRK 1041 L

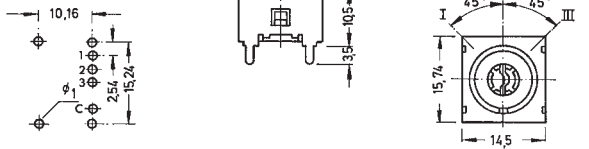

Step angle 90°

- MRK 1012 A – R
- MRK 1012 B – R
- MRK 1022 B – R

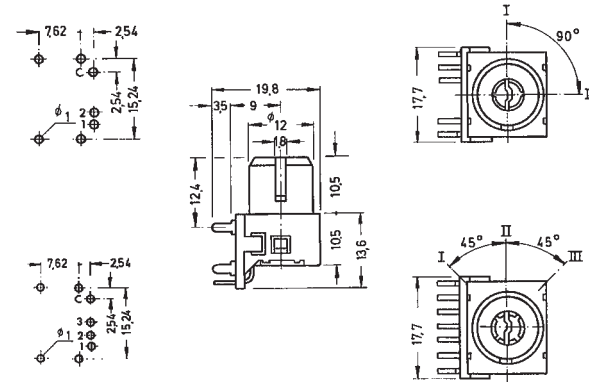

Step angle 45°

- MRK 1031 D – R
- MRK 1031 L – R
- MRK 1041 L – R

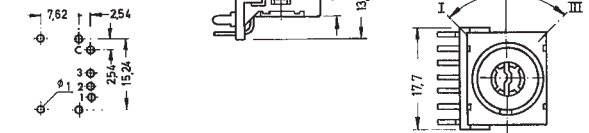

Special versions:*

Key switch with security casing:

Type:
MRKC

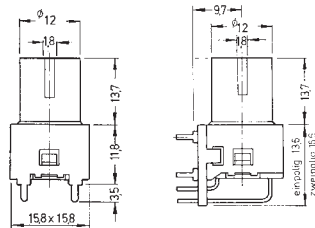

Key switch with plastic case and plastic key

Type:
MRKS

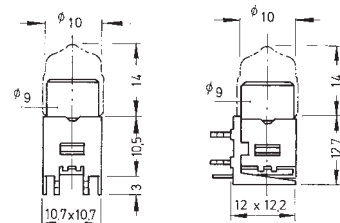

* Minimum quantity and delivery time on request

8

Encoder



MEOP 19	180
MER 9 / MERP 9	181 – 182
MER 10-12 R7	183
MER 11 / MERS 11 / MERP 11 / MERPS 11	184 – 186
MER 12 / MERP 12 illuminated	187 – 189
MER 23	190
MER 1045-24	191
MRP 1	192

Optical Encoder



Specifications:

Power supply:	3.3 to 5 V DC, 10 mA max.	
Insulation resistance:	> 100 MΩ	
Dielectric strength:	300 V, 50 Hz for the duration of 1 minute	
Operating temperature:	-10 °C to +50 °C	
Rotational torque:	0.45 ± 0.2 Ncm	
Pulses/Detents per turn:	6/0, 6/6, 24/0, 24/24	
Frequency response:	100 Hz max.	
Electrical life:	> 1 000 000 turns	
Pushbutton:	Contact rating:	12 V DC, 10 mA, min. 0.1 mA
	Contact resistance:	< 10 Ω
	Operating force:	4 ± 2 N
	Electrical Life:	> 1 000 000 cycles
	Travel:	0.3 ± 0.05 mm, 1 ± 0.2 mm
	Mounting:	on pc-board with pin-contact single hole mounting M 9 x 0.75
Soldering conditions:	wave soldering, max. 3 sec, 280 °C, pre-heat max. 60 sec, 100 °C	

Models:

MEOP 19 VG06CR08MTFM1

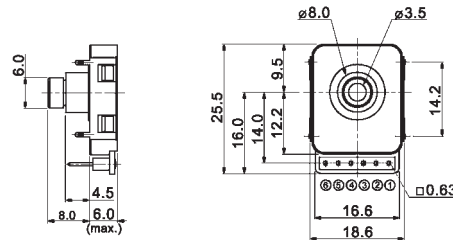

MEOP 19 VG24CF21MTFM2

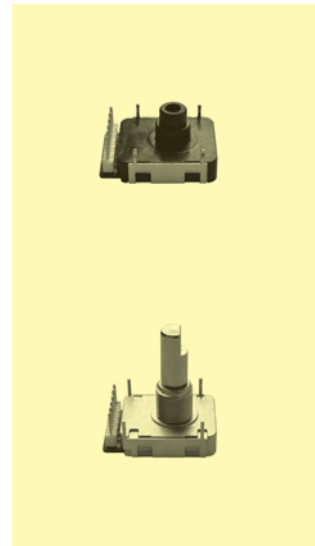
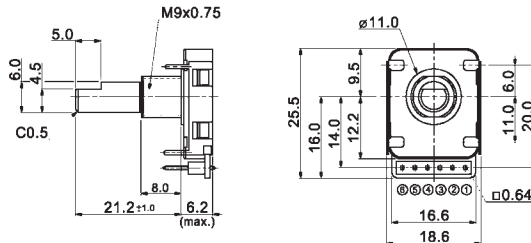

Output signal format:

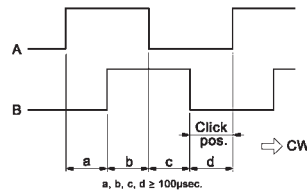

Pin assignment:

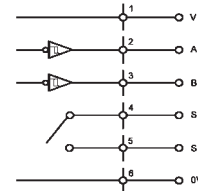

Ordering code: MEOP 19 T M Internal number

Shaft direction:
 horizontal
 vertical

Pulses:
 06
 24

Switch travel:
 1 ± 0.2 mm
 0.3 ± 0.05 mm

Detents:
 with detent
 no detent

Connector type:
 female
 male

Connector direction:
 front
 rear

Shaft type:
 flat
 round

Shaft Length:
 08
 17
 21



Specifications:

Contact rating:	5 V DC, 1 mA
Insulation resistance:	> 100 MΩ
Dielectric strength:	300 V, 50 Hz for the duration of 1 minute
Operating temperature:	-10 °C to +65 °C
Rotational/Detent torque:	0,5/1,0 Ncm
Pulses/Detents per turn:	15/30
Mechanical life:	> 15 000 cycles
Pushbutton (optional):	actuation force 5 N, travel 0,5 mm, life > 10 000 operations
Contacts:	silver-plated
Terminals:	silver-plated
Mounting:	on pc-board single hole mounting M 7 x 0,75
Soldering conditions:	auto-soldering – max.: 5 sec, 260 °C

Models:

MER9-15220BM7R

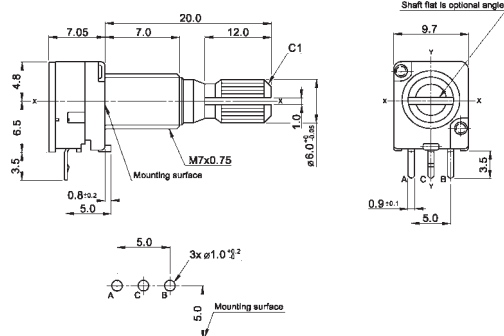

MER9-15115AM7R

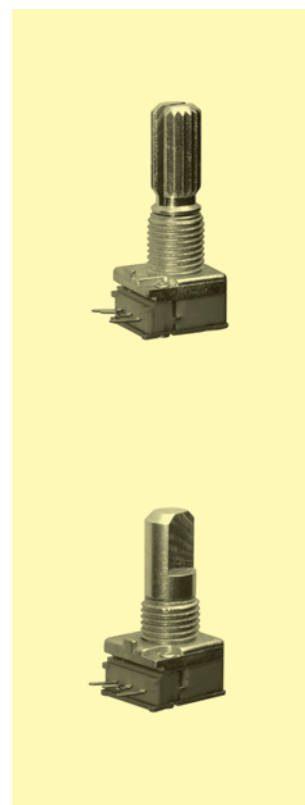
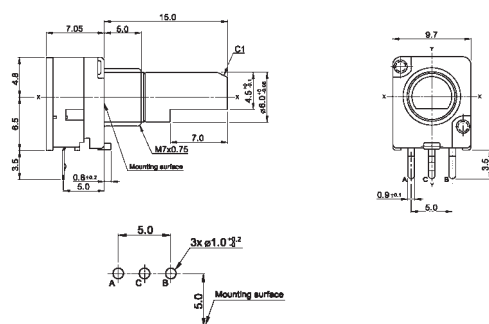

Output signal format:

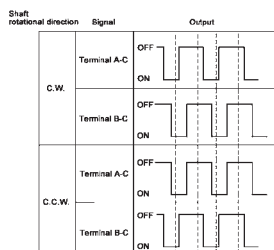

Encoder



Models:

MER9-15325CM7R

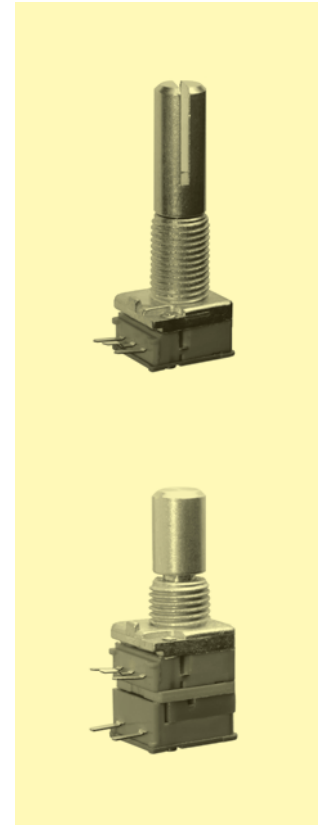
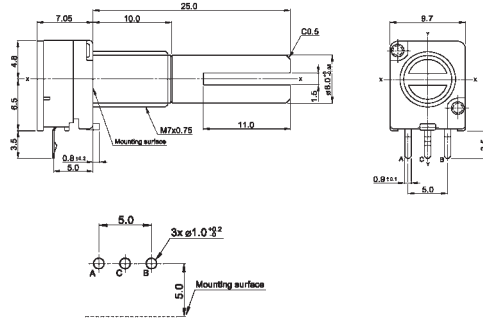

MERP9-15415AM7R

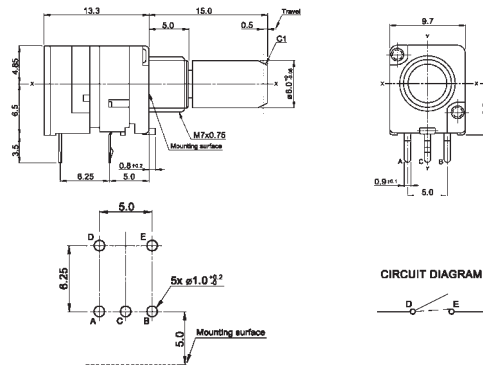

Output signal format:

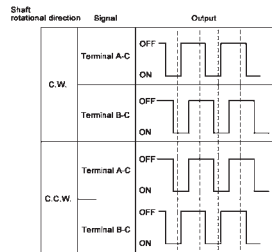

Ordering code 9 mm Encoder:

MER 9 -

Switch function:

- no switch
- switch

Shaft type:

- 1 flat shaft
- 2 knurled shaft
- 3 cut shaft
- 4 round shaft

Bushing:

- A 5 mm
- B 7 mm
- C 10 mm

Orientation:

- horizontal

Number of pulses:

- 12 12 pulses
- 15 15 pulses

Shaft length:

- 15 15 mm
- 20 20 mm
- 25 25 mm

Bushing thread:

- M7
- no thread



Encoder

Specifications:

Contact rating:	5 V DC, 1 mA
Contact resistance:	< 1 Ω
Insulation resistance:	> 10 MΩ
Dielectric strength:	50 V, 50 Hz for the duration of 1 minute
Operating temperature:	-5 °C to +45 °C
Rotational torque:	0.5 ± 0.3 Ncm
Pulses/Detents per turn:	12/24
Mechanical life:	minimum 100 000 turns
Contacts and terminals:	silver-plated
Mounting:	on pc-board with pin-contact
Soldering conditions:	wave soldering, max. 3 s max. 260 °C, pre-heat max. 60 s max. 100 °C

Models:

MER10-12 R7

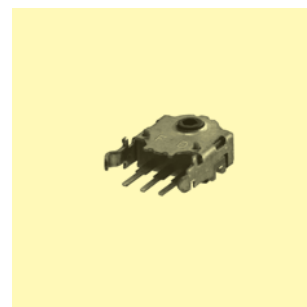
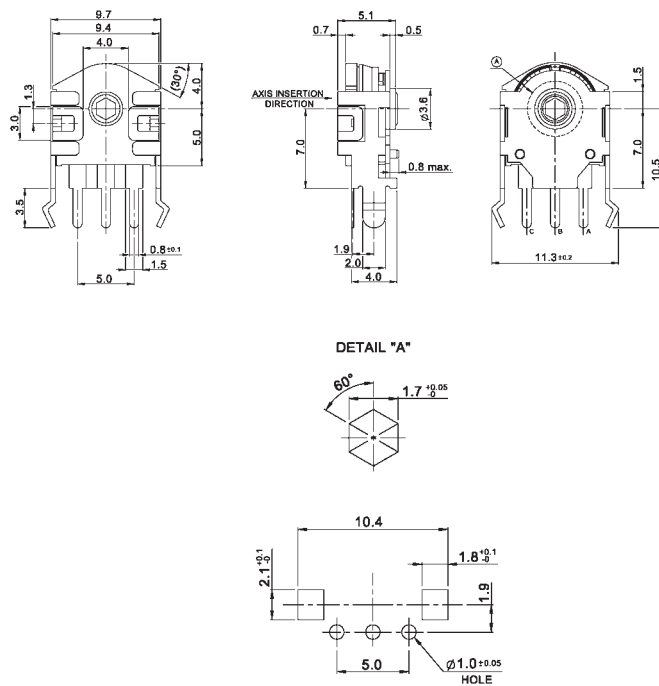

Output signal format:

Shaft rotational direction	Signal	Output	
C.W.	Terminal A-C	OFF ON	
	Terminal B-C	OFF ON	
C.C.W.	Terminal A-C	OFF ON	
	Terminal B-C	OFF ON	

Encoder



Specifications:

Contact rating:	5 V DC, 10 mA
Insulation resistance:	> 100 MΩ
Dielectric strength:	300 V, 50 Hz for the duration of 1 minute
Operating temperature:	-10 °C to +85°C
Rotational/Detent torque:	0,5/1,2 Ncm
Pulses/Detents per turn:	15/30 or 20/20
Mechanical life:	> 15 000 cycles
Pushbutton (optional):	actuation force 6 N, travel 0,5 mm, life > 25 000 operations
Contacts:	silver-plated
Terminals:	silver-plated
Mounting:	on pc-board
	single hole mounting, bushing M 7 x 0,75
Soldering conditions:	auto-soldering – max.: 5 sec, 260 °C

Models:

MER11-15125B

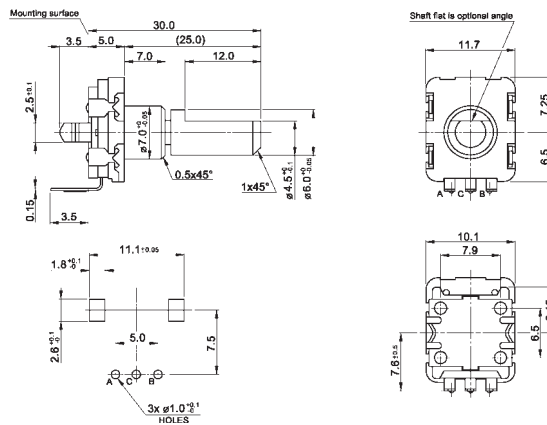

MERP11-15325B

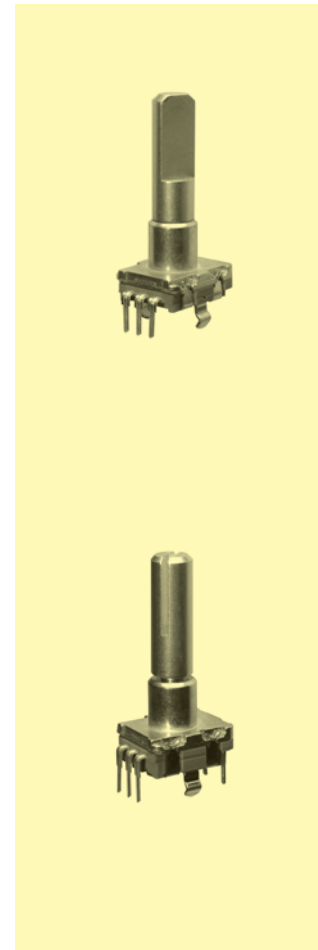
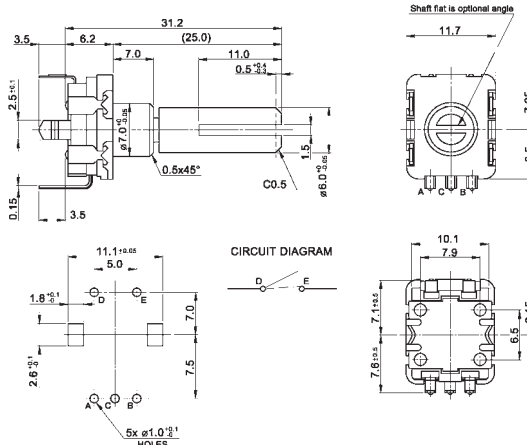



Models:

MER11-15215A-R

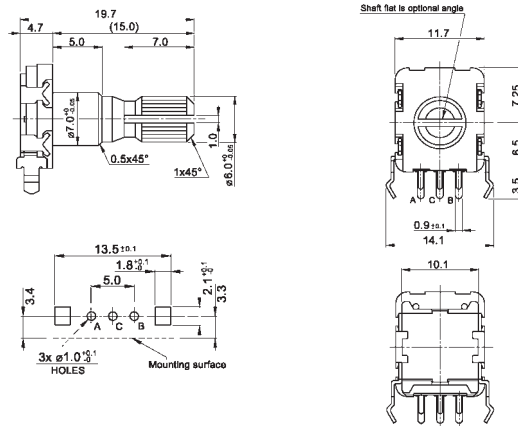

MERP11-2042BM7-R

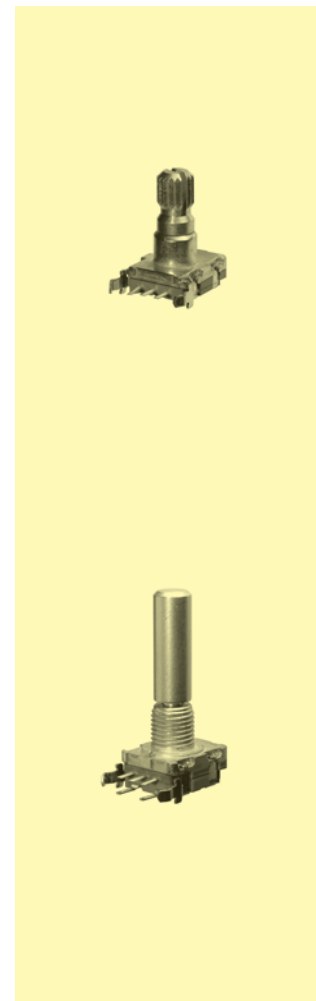
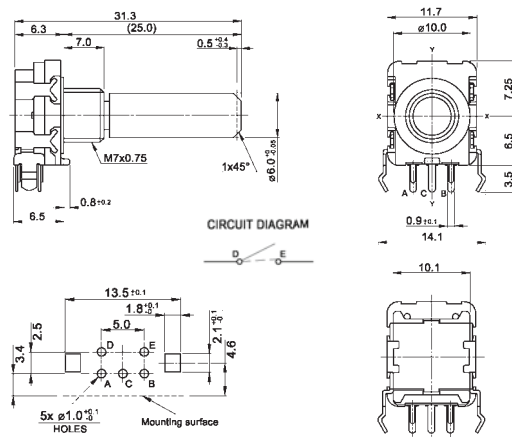

Output signal format:

Shaft rotational direction	Signal	Output
C.W.	Terminal A-C	OFF ON
	Terminal B-C	OFF ON
C.C.W.	Terminal A-C	OFF ON
	Terminal B-C	OFF ON

Ordering code 11 mm Encoder:

MER 11 -

Switch function:
 no switch
 switch

PCB mounting:
 through hole
 SMD

Shaft type:
 1 flat shaft
 2 knurled shaft
 3 cut shaft
 4 round shaft

Bushing:
 A 5 mm
 B 7 mm

Orientation:
 horizontal
 vertical

Number of pulses:
 15 15 pulses
 20 20 pulses

Shaft length:
 15 15 mm
 20 20 mm
 25 25 mm

Bushing thread:
 M7 M7
 no thread

Specifications:

Contact rating:	5 V DC, 10 mA
Insulation resistance:	> 100 MΩ
Dielectric strength:	300 V, 50 Hz for the duration of 1 minute
Operating temperature:	-40 °C to +85 °C
Rotational/Detent torque:	0,5/1,0 Ncm
Pulses/Detents per turn:	15/30 or 20/20
Mechanical life:	> 15 000 cycles
Pushbutton (optional):	actuation force 4 N, travel 0,5 mm, life > 25 000 operations
Contacts:	silver-plated
Terminals:	silver-plated
Mounting:	on pc-board – SMD

Models:

MERPS11-15213

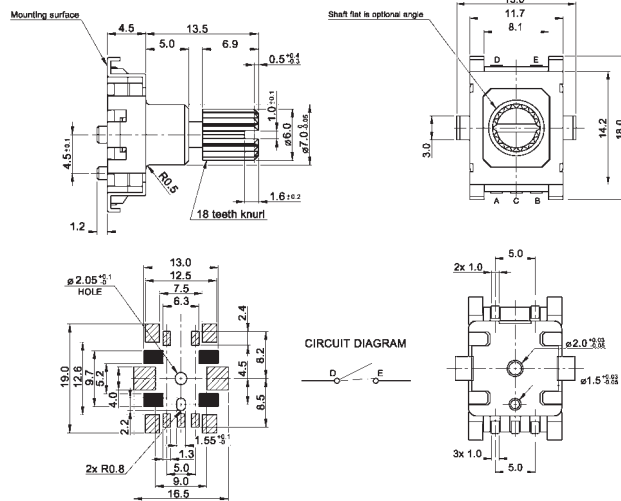

MERS11-15295

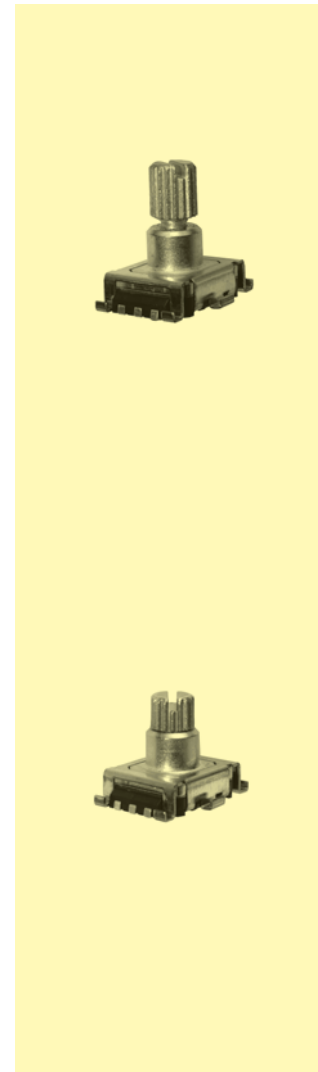
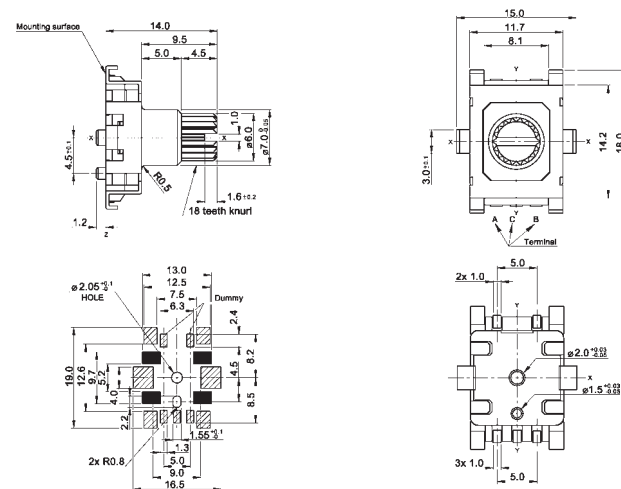



Specifications:

Contact rating:	5 V DC, 0.5 mA
Insulation resistance:	> 100 MΩ
Dielectric strength:	300 V, 50 Hz for the duration of 1 minute
Operating temperature:	-10 °C to +70 °C
Rotational/Detent torque:	0,5 N/2,0 Ncm
Pulses/Detents per turn:	12/24 or 24/24 (12/12, 12/0, 24/0 on demand)
Mechanical life:	>30 000 cycles
Pushbutton (optional):	actuation force 3 N, travel 0,5 mm, life > 20 000 operations
Contacts:	silver-plated
Terminals:	silver-plated
Mounting:	on pc-board
Soldering conditions:	single hole mounting, bushing M 9 x 0,75 auto-soldering – max.: 5 sec, 260 °C

Models:

MER12-24120

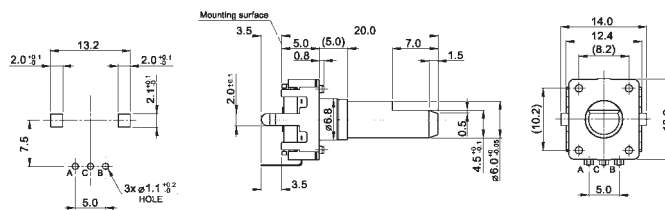

MERP12-24115

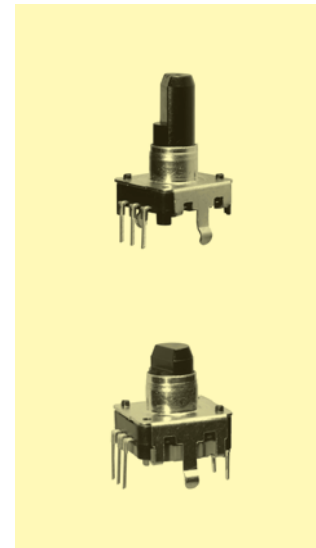
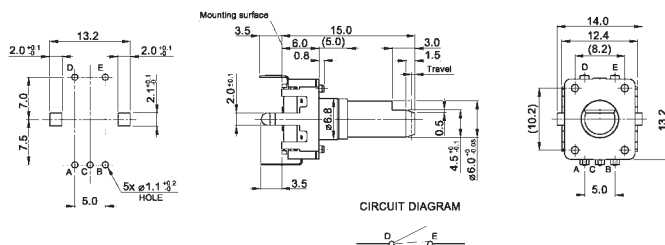

Ordering code 12 mm Encoder:

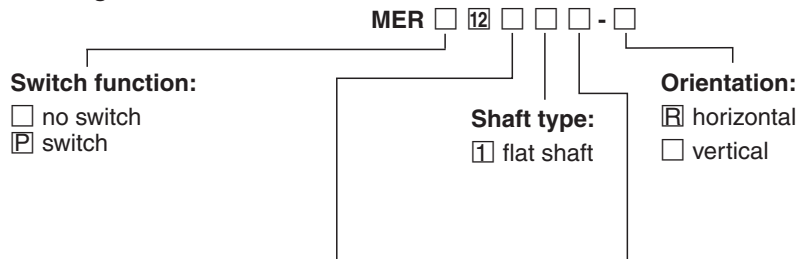

Number of pulses:

- 12 12 pulses
- 24 24 pulses

Shaft length:

- 8.5 8,5 mm
- 15 15,0 mm
- 17.5 17,5 mm
- 20 20,0 mm
- 25 25,0 mm

Output signal format:

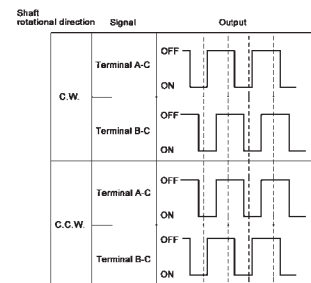



Illuminated Encoder

Specifications:

Contact rating:	5 V DC, 0.5 mA
Insulation resistance:	>100 MΩ
Dielectric strength:	300 V, 50 Hz for the duration of 1 minute
Operating temperature:	-10 °C to +70 °C
Rotational/Detent torque:	0.5 Ncm / 2.0 Ncm
Pulses/Detents per turn:	12/12 or 24/24, version "N": no detent
Mechanical life (cycle function):	minimum 30 000 turns
Pushbutton function:	Actuation force 4.5 ± 2 N, travel 0.5 mm, mechanical life >20 000 operations
Material:	Contacts: stainless steel, silver-plated
Contacts and terminals:	silver-plated
Mounting:	on pc-board with pin-contact
Illuminating:	RGB-LED
Soldering conditions:	wave soldering, max. 5 s max. 260 °C, pre-heat max. 60 s max. 100 °C

Models:

MERP12-24225M

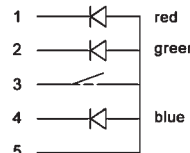
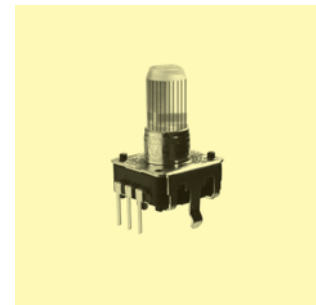
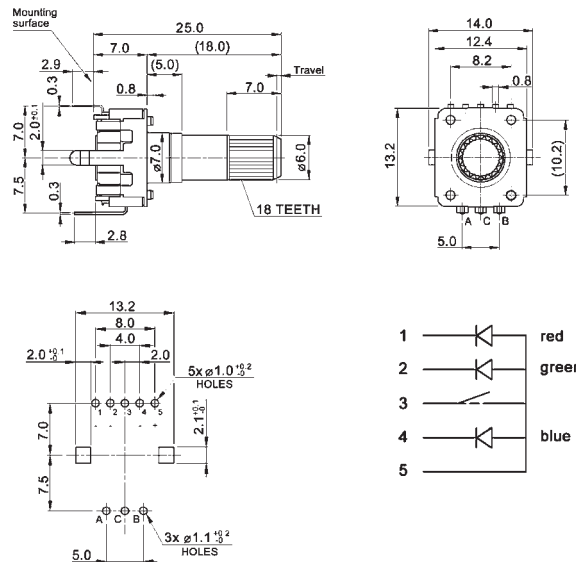

Output signal format:

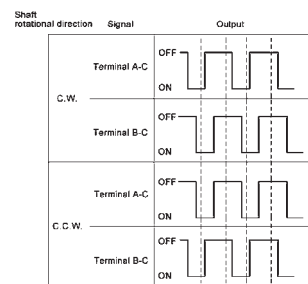

Ordering code 12 mm Encoder:

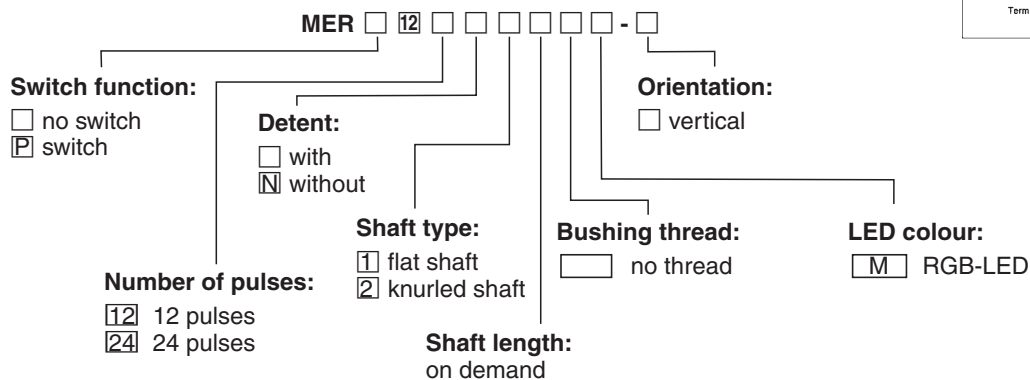

Specifications:

Contact rating:	5 V DC, 10 mA
Contact resistance:	<1 Ω
Insulation resistance:	>100 MΩ
Dielectric strength:	100 V, 50 Hz for the duration of 1 minute
Operating temperature:	-10 °C to +70 °C
Rotational torque:	0.6 ± 0.41 Ncm
Pulses/Detents per turn:	20/20
Mechanical life:	minimum 30 000 turns
Material:	Contacts: stainless steel, silver-plated
Contacts and terminals:	silver-plated
Mounting:	on pc-board with pin-contact
Soldering conditions:	wave soldering, max. 5 s max. 250 °C, pre-heat max. 60 s max. 100 °C

Models:

MER23-20

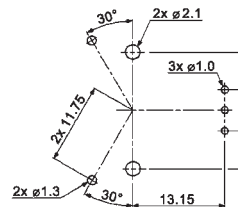
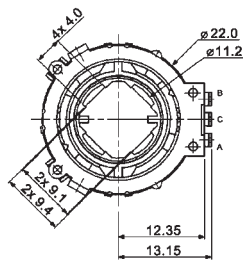
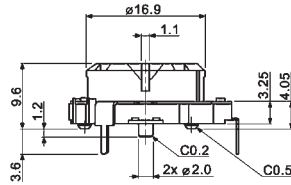
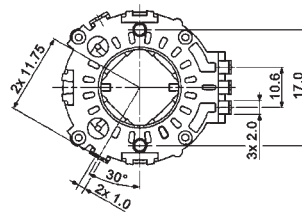

Output signal format:

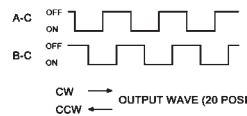



Specifications:

Contact rating:	5 V DC, 10 mA
Contact resistance:	< 1 Ω
Insulation resistance:	> 100 MΩ
Dielectric strength:	100 V, 50 Hz for the duration of 1 minute
Operating temperature:	-10 °C to +60 °C
Rotational torque:	0.3 ± 0.05 Ncm
Pulses/Detents per turn:	24/24
Mechanical life:	minimum 50 000 turns
Contacts and terminals:	silver-plated
Mounting:	on pc-board – SMD
Soldering conditions:	reflow soldering, max. 10 sec max. 240 °C

Models:

MER1045-24

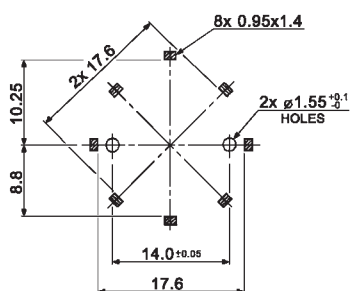
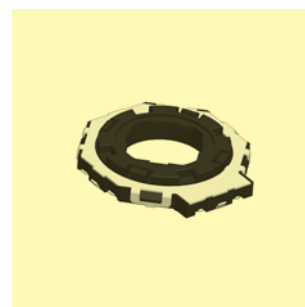
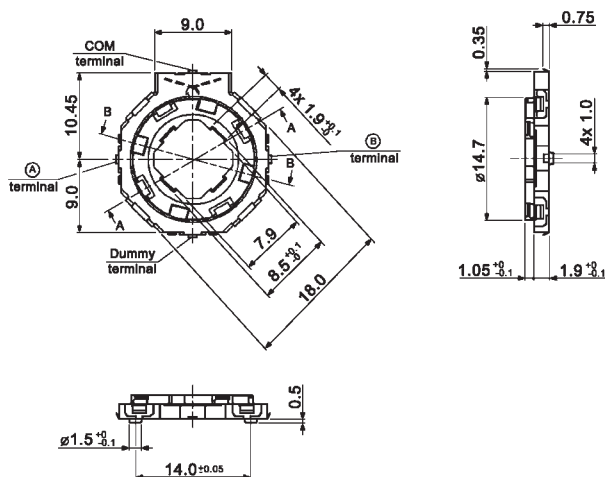

Output signal format:

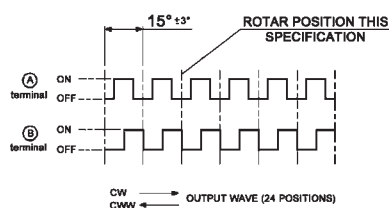



Specifications:

Contact rating:	5 V DC, 10 mA
Insulation resistance:	> 100 MΩ
Dielectric strength:	250 V, 50 Hz for the duration of 1 minute
Operating temperature:	-25 °C to +70 °C
Mechanical life:	minimum 10 000 operations
Contacts:	phosphor bronze, gold-plated
Terminals:	PC terminals
Material:	case: PBT black; frame: steel, tin-plated; rotor: PA
Mounting:	on pc-board or single hole mounting, bushing M 7 x 0,75, key 11 mm
Soldering conditions:	auto-soldering – max.: 5 sec, 250 °C ± 5 °C

Models:

MRP 1 – 20

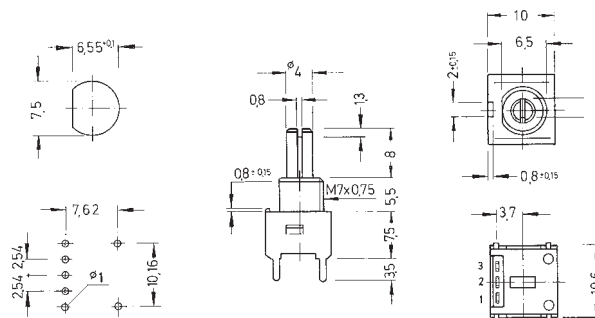

MRP 1 – 20 – R

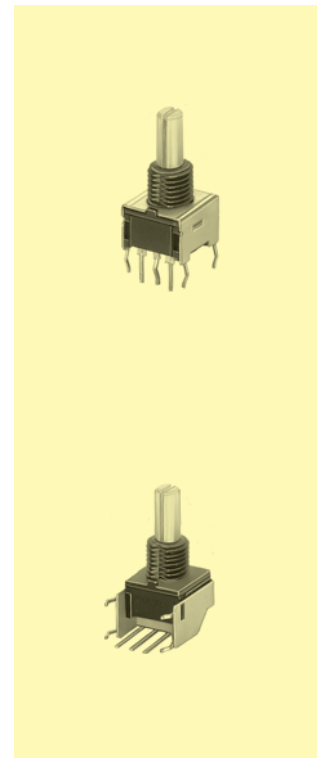
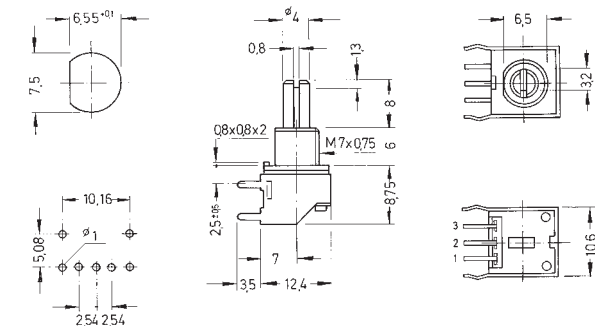

Mounting set for single hole mounting

1 nut M 7 x 0,75, key 11 mm

1 washer Ø 12 mm

Order number

RR 775

Circuit diagram – 20 pulses/circle ± 2 pulses

Contact between pulse	Angle	0	18°	36°	324°	342°	360°
2-1 on							
2-1 off							
2-3 on							
2-3 off							

9

Micro / Snap Action Switches

9.1 Miniature Micro / Snap Action Switches



TMV

194

DM – VMS

195 – 197

9.2 Subminiature Micro / Snap Action Switches



DM – SM

198 – 200

DM – SW IP 51

201 – 202

9.3 Microminiature Micro / Snap Action Switches



DM – DM

203

DM – SSM

204

Miniature Micro / Snap Action Switches



Specifications:

Contact rating:	250 V AC, 10 A
Contact resistance:	< 15 mΩ
Insulation resistance:	> 100 MΩ
Dielectric strength:	1000 V, 50 Hz for the duration of 1 minute
Operating temperature:	-25 °C to +65 °C
Mechanical life:	minimum 20 000 000 operations
Contacts:	silver-alloy
Terminals:	brass, silver-plated
Case:	PBT (UL 94 V-0)
Mounting:	on panel, hole Ø 3.1 mm
Timing:	non-shorting, positive break (force-driven)

Models: Switching function

SPDT

TMV 104 C on - mom

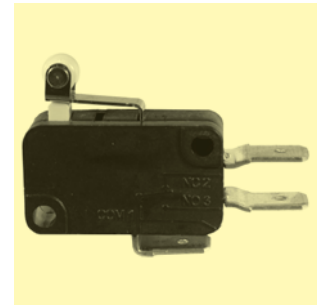
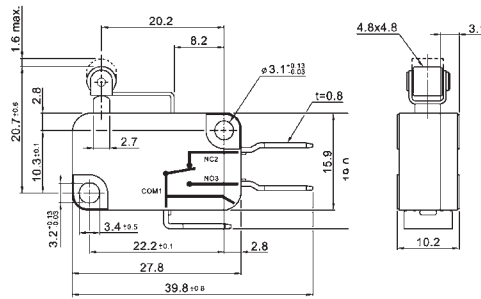

Actuator:

Actuator 0

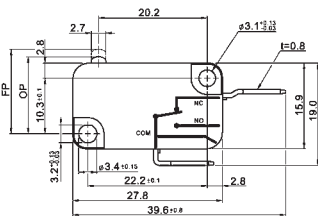

Actuator 2

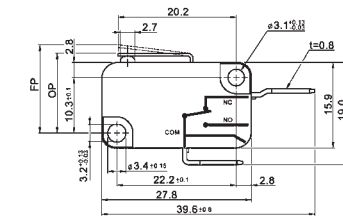

Actuator 4

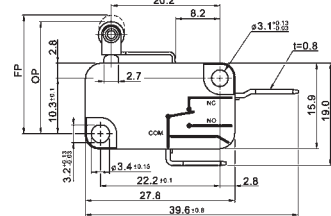

Actuator 1

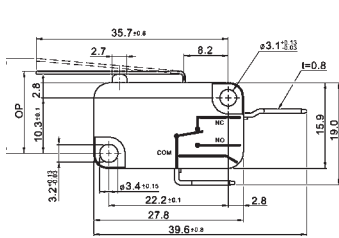

Actuator 3

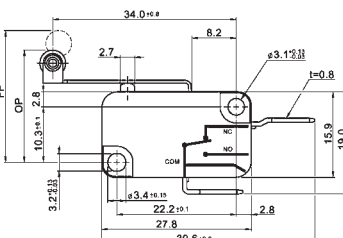

Actuator 5

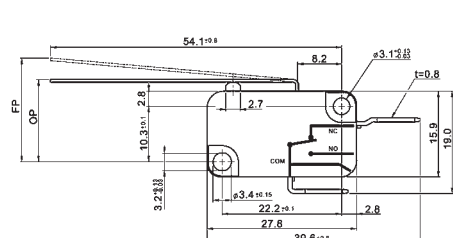

Ordering code:

TMV 10 - C

- Terminals
 - change-over switch (3 terminals)
 - normally closed (2 terminals)
- Actuator

Actuator	Operating force [gf]	Free position [mm]	Operation position [mm]
0	200	16.1±0.5	14.7±0.5
1	125	19.2±1.2	15.2±1.2
2	200	16.8±0.5	15.2±0.5
3	125	24.7±1.2	20.7±1.2
4	240	22.3±0.6	20.7±0.6
5	70	24.2±2.5	15.2±2.5



Miniature Micro / Snap Action Switches

Specifications:

Contact rating:	250 V AC, 15 A
Contact resistance:	< 100 mΩ
Insulation resistance:	> 100 MΩ
Dielectric strength:	1500 V, 50 Hz for the duration of 1 minute
Operating temperature:	-25 °C to +85 °C
Mechanical life:	minimum 1 000 000 operations
Contacts:	silver-alloy
Terminals:	brass, silver-plated
Case:	PBT (UL 94 V-0)
Mounting:	on panel
Timing:	non-shorting

Models: Switching function

SPDT

DM-VMS15-05N-250 on - mom

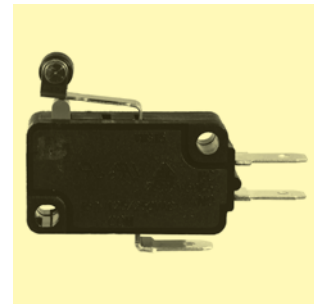
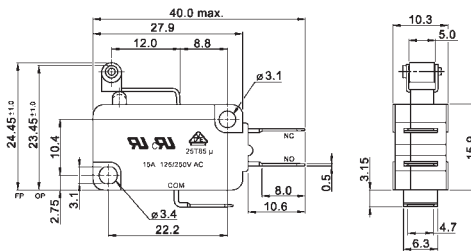

Actuator	Operation force [gf]						Free position [mm]	Operation position [mm]
	60±25	80±30	110±30	160±40	200±50	250±50		
00	60±25	80±30	110±30	160±40	200±50	250±50	18.35±0.5	17.45±0.5
01	60±25	80±30	110±30	160±40	200±50	250±50	19.05±0.5	18.05±0.5
02	30±10	40±15	50±20	75±25	100±40	120±40	20.75±0.8	18.25±0.8
03	12±5	25±10	30±10	40±15	50±25	60±25	22.55±2.0	18.05±2.0
04	35±15	45±20	55±20	85±30	110±30	140±40	23.95±1.5	21.75±1.5
05	60±25	80±30	110±30	160±40	200±50	250±50	24.45±1.0	23.45±1.0

Ordering code:

DM-VMS15 - □□□ - □□□

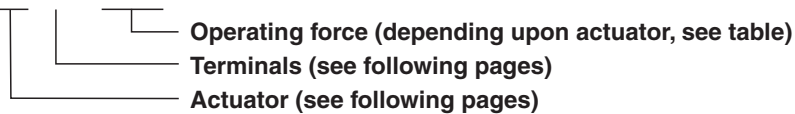

Miniature Micro / Snap Action Switches



DM-VMS15 Terminals (fast-on 6.3 mm)

Terminal M

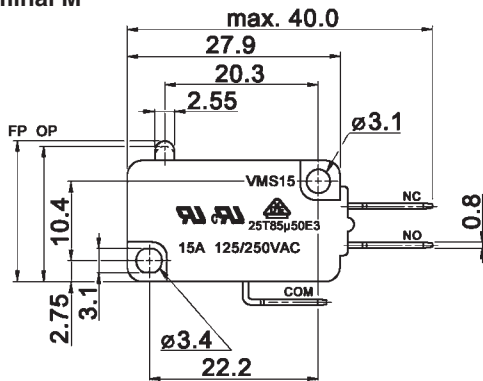

Terminal K

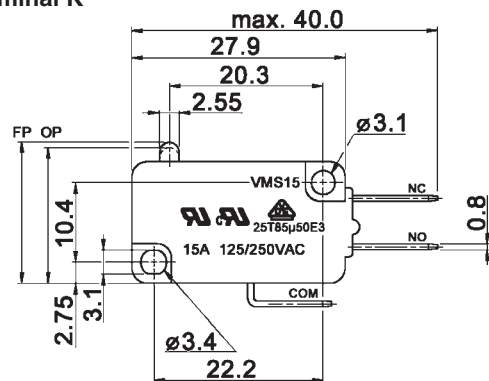

Terminal H

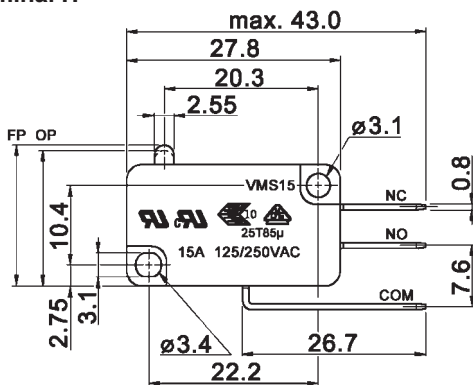

Terminal N

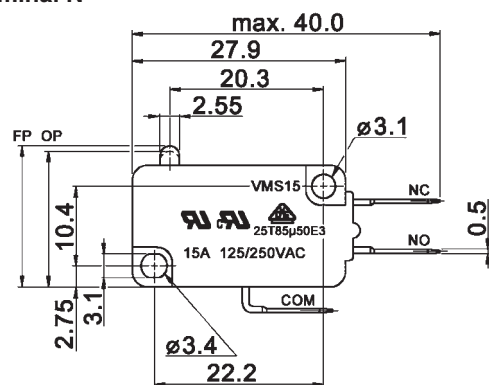

Terminal L

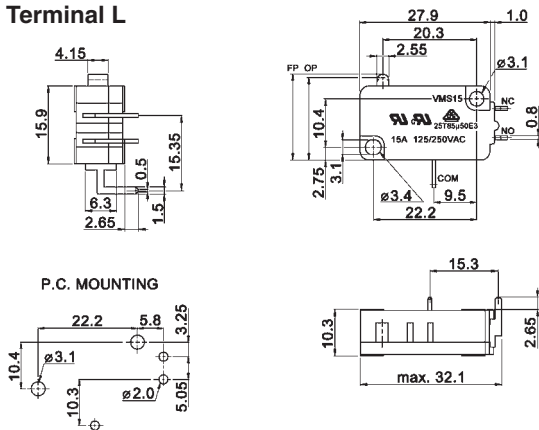

Terminal J

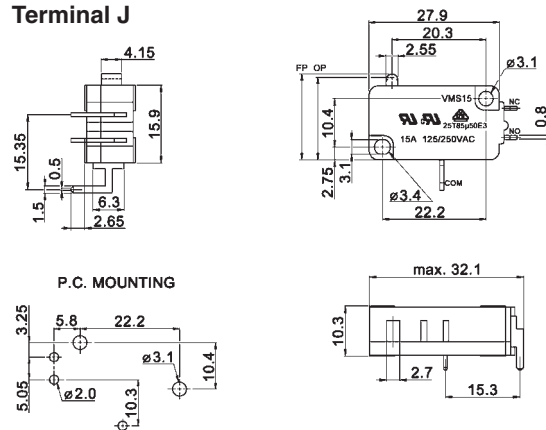

Terminal A

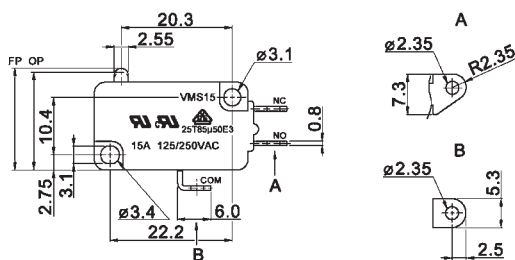

Terminal W (tab width 7.5)

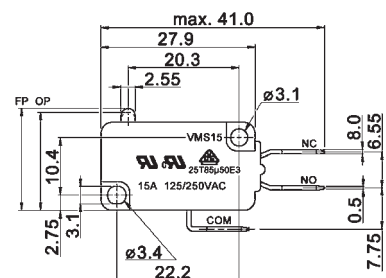

Subminiature Micro / Snap Action Switches



Specifications:

Contact rating:	250 V AC, 5 A / 250 V AC, 3 A / 30 V DC, 0.5 A
Contact resistance:	< 50 mΩ
Insulation resistance:	> 100 MΩ
Dielectric strength:	1000 V, 50 Hz for the duration of 1 minute
Operating temperature:	-25 °C to +80 °C
Mechanical life:	minimum 1000 000 operations
Contacts:	silver-alloy
Terminals:	brass, silver-plated
Case:	PBT (UL 94 V-0)
Mounting:	on pc-board, on panel
Timing:	non-shorting
Soldering conditions:	auto-soldering – max. 3 sec, max. 250 °C manual soldering – max. 3 sec, max. 380 °C

Models: Switching function

SPDT

DM-SM3 01 N-30S on - mom

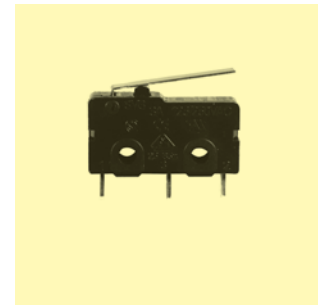
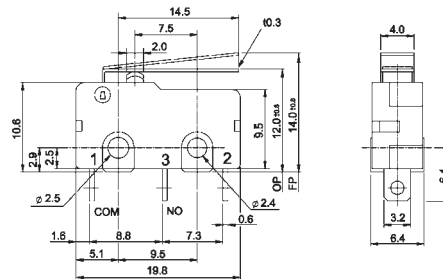

Packing: 1000 pcs/bag

Actuator	Operating force [gf]									Free position [mm]	Operation position [mm]
	80±25	95±30	115±40	130±40	150±40	175±45	190±45	250±50	295±55		
00	80±25	95±30	115±40	130±40	150±40	175±45	190±45	250±50	295±55	11.9±0.3	11.3±0.3
01	25±12	30±12	35±20	40±20	45±20	50±20	55±25	70±25	85±30	14.0±0.8	12.0±0.8
02	20± 8	25±12	30±12	35±20	40±20	45±20	50±20	65±25	75±25	14.2±0.8	12.1±0.8
03	15± 6	20± 6	25±12	30±12	35±20	40±20	55±25	60±25	70±25	15.0±1.0	12.4±0.8
04	20± 8	25±12	30±12	35±20	40±20	45±20	50±20	65±25	75±25	16.7±0.8	14.5±0.8
05	20± 8	25±12	30±12	35±20	40±20	45±20	50±20	65±25	75±25	19.8±1.0	17.8±1.0

Ordering code:

DM-SM - - S

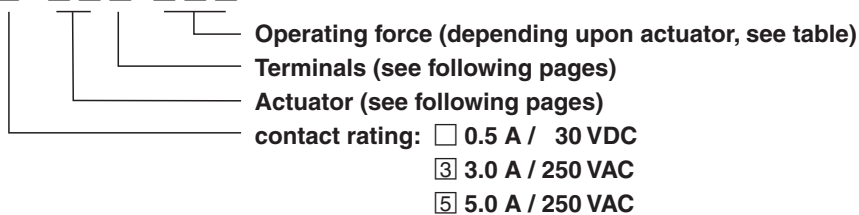



Subminiature Micro / Snap Action Switches

DM-SM Terminals

Terminal N

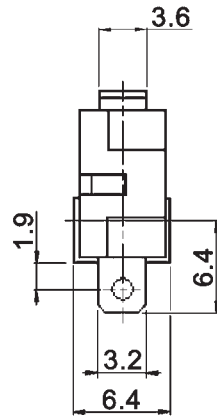

Terminal P

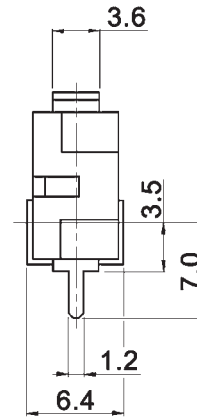

Terminal L

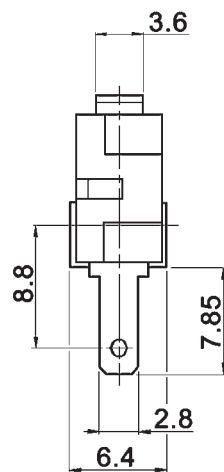

Terminal C

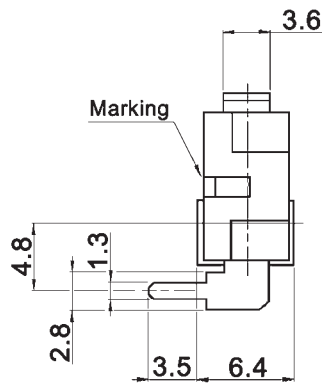

Terminal D

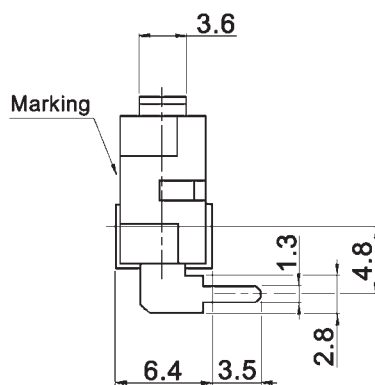

Subminiature Micro / Snap Action Switches



DM-SM Actuator

Actuator 00

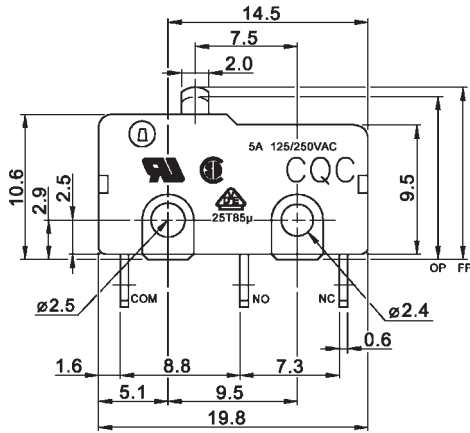

Actuator 01

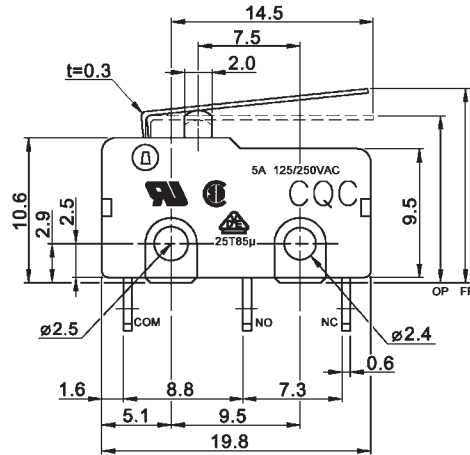

Actuator 02

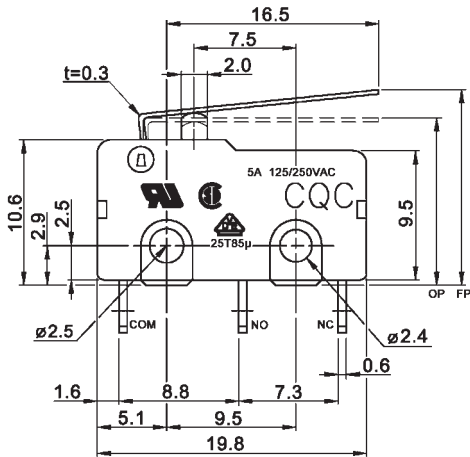

Actuator 03

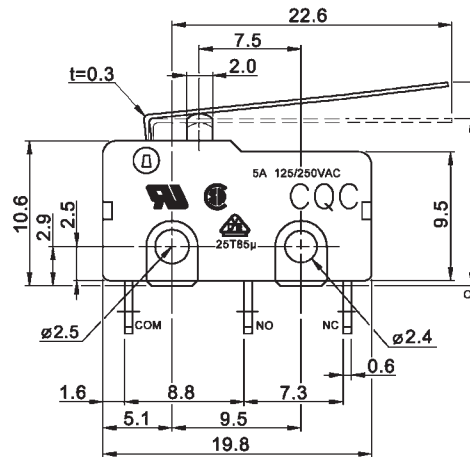

Actuator 04

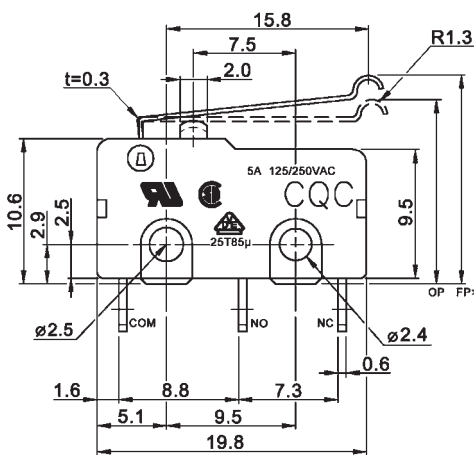

Actuator 05

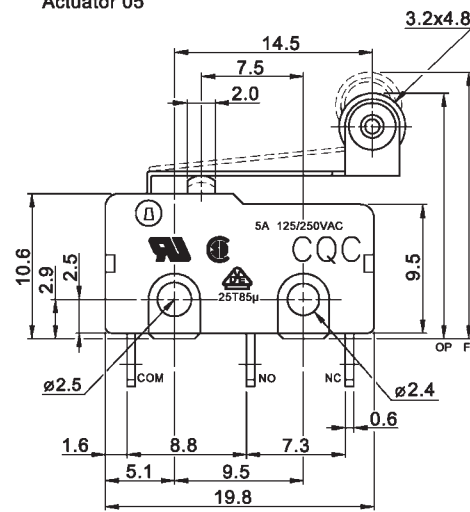



Subminiature Micro / Snap Action Switches

Specifications:

Contact rating:	250 V AC, 5 A
Contact resistance:	< 50 mΩ
Insulation resistance:	> 100 MΩ
Dielectric strength:	1000 V, 50 Hz for the duration of 1 minute
Operating temperature:	-15 °C to +70 °C
Mechanical life:	minimum 100 000 operations
IP rating:	IP 51
Contacts:	silver-alloy
Terminals:	brass, silver-plated
Case:	body: PA (UL 94V-0) stem: PBT (UL 94 V-0) Sealing: rubber (UL 94 V-0)
Mounting:	P: on pc-board – hole diameter 1.65 mm N: on panel
Timing:	non-shorting
Soldering conditions:	auto-soldering – max. 3 sec, max. 250 °C manual soldering – max. 3 sec, max. 380 °C

Models: Switching function

S P D T

DM-SW5-00N-115 on – mom

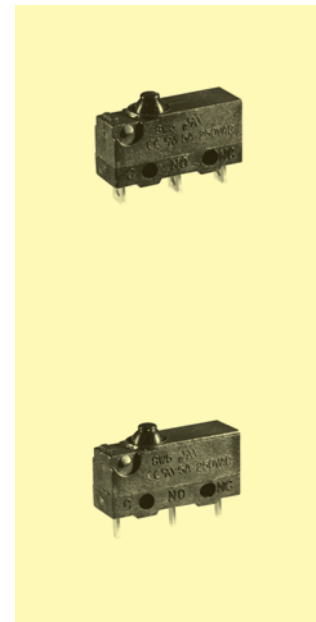
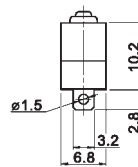
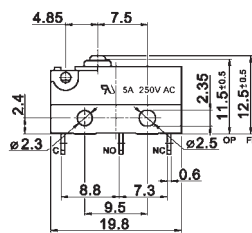

DM-SW5-00P-250 on – mom

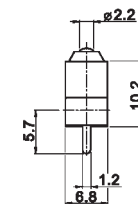
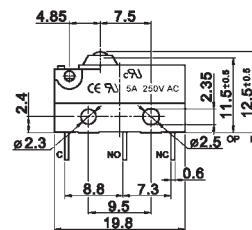

Actuator	Operating force [gf]					Free position [mm]	Operation position [mm]
	00	01	04	05			
00	115±40	130±40	150±40	175±40	250±50	12.5±0.5	11.5±0.5
01	45±20	50±20	55±20	60±20	100±40	12.0±1.0	15.0±1.0
04	40±20	45±20	50±20	55±20	90±30	17.5±1.0	14.2±1.2
05	40±20	45±20	50±20	55±20	90±30	19.0±1.5	16.5±1.0

Ordering code:

DM-SW5 - □□□ - □□□□

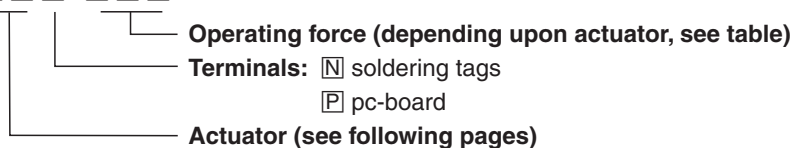

Subminiature Micro / Snap Action Switches



DM-SW5 Actuator

Actuator 00

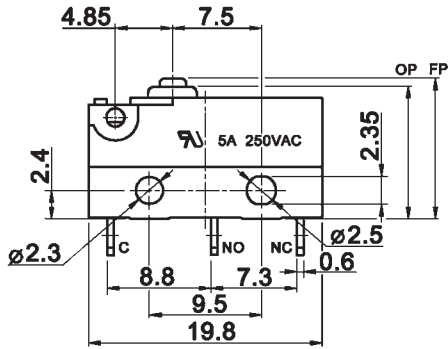

Actuator 01

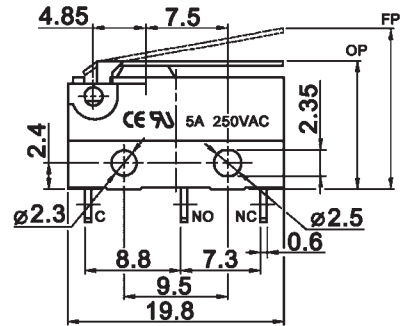

Actuator 04

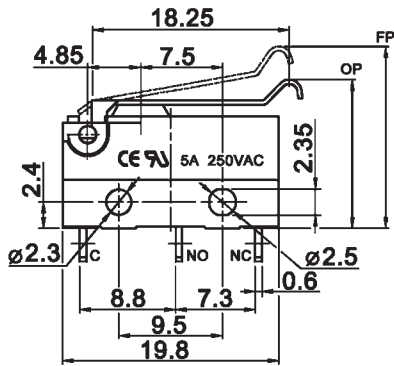

Actuator 05

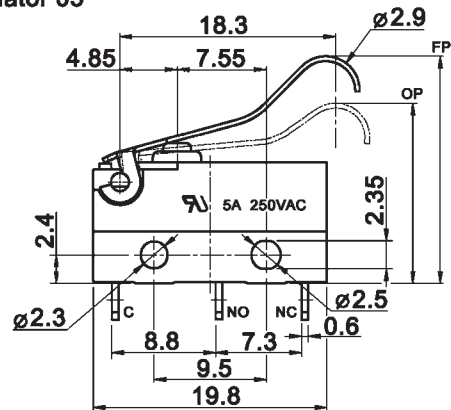



Microminiature Micro / Snap Action Switches

Specifications:

Contact rating:	125 V AC, 1 A
Contact resistance:	< 100 mΩ
Insulation resistance:	> 100 MΩ
Dielectric strength:	500 V, 50 Hz for the duration of 1 minute
Operating temperature:	-25 °C to +75 °C
Mechanical life:	minimum 500 000 operations
Contacts:	silver-alloy
Terminals:	brass, silver-plated
Case:	PBT (UL 94 V-0)
Mounting:	on pc-board – hole diameter 1.2 mm, on panel – hole diameter 2.1 mm
Timing:	non-shorting
Soldering conditions:	auto-soldering – max. 3 sec, max. 250 °C (pre-heat max. 60 s, max 100 °C) manual soldering – max. 3 sec, max. 350 °C

Models: Switching function

S P D T

DM-DM 00 P
Operating force 110 gf

on – mom

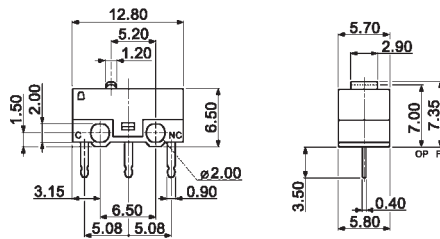

DM-DM 01 P
Operating force 40 gf

on – mom

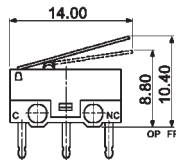

DM-DM 02 P
Operating force 30 gf

on – mom

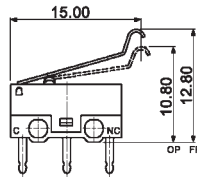

DM-DM 03 P
Operating force 35 gf

on – mom

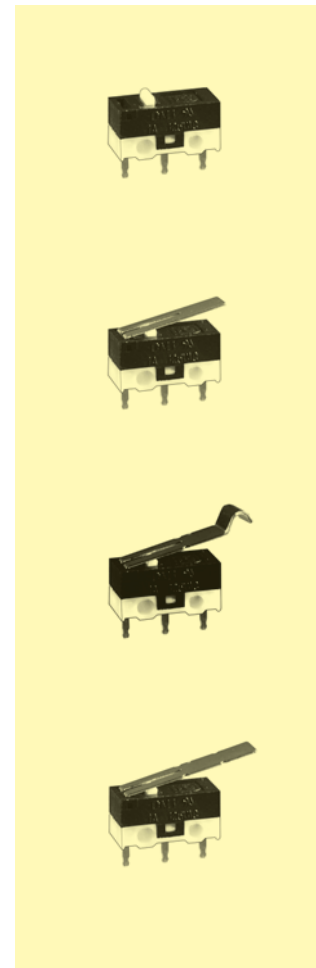
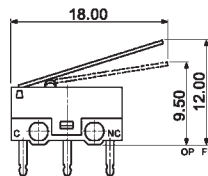

Further types on request

Microminiature Micro / Snap Action Switches



Specifications:

Contact rating:	30 V AC, 0.5 A
Contact resistance:	< 100 mΩ
Insulation resistance:	> 100 MΩ
Dielectric strength:	250 V, 50 Hz for the duration of 1 minute
Operating temperature:	-20 °C to +70 °C
Mechanical life:	minimum 300 000 operations
Operating force:	< 50 gf
Contacts:	copper alloy, silver-plated
Terminals:	brass, silver-plated
Case:	base: PBT cover, stem, lever: POM
Mounting:	on pc-board – hole diameter 1.5 mm, on panel – hole diameter 1.6 mm
Timing:	non-shorting
Soldering conditions:	auto-soldering – max. 3 sec, max. 260 °C

Models: Switching function

S P D T

DM-SSM 01 L2 on – mom

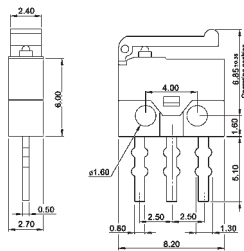

DM-SSM 01 D L2 on – mom

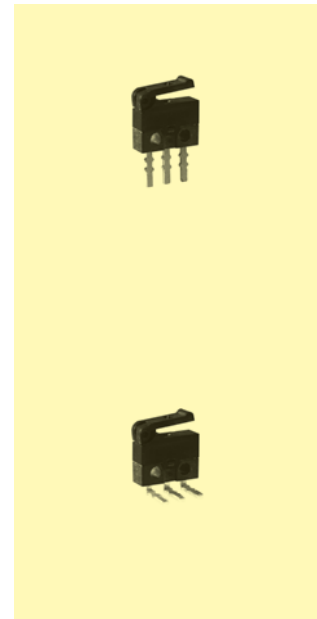
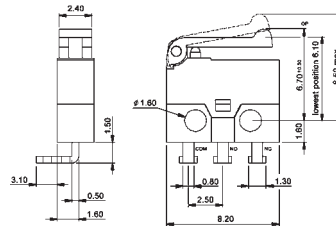

Further types on request

10 LEDs

LED Indicators

206 – 209



LED-Indicators



LED-INDICATORS – red section

We offer a complete range of high-quality bracket indicators. Diodes are carefully selected for constant colour and brightness, housings are solid brass and chromium-plated.

LED-Indicators

Ø 7 mm



Ø 7 mm



Ø 10,5 mm



Ø 9 mm
superbright



Ø 12,2 mm
waterproof



Ø 7 mm
tricoloured



Ø 9 mm
tricoloured



Ø 9 mm
flashing



Ø 12,2 mm
waterproof



with lead and
connector



LED-Indicators

Specifications:									
Models	P Power dissipation (mW)	V _F Forward voltage (V) ¹	I _F Forward current (mA)	I _V Luminous intensity (mcd) at I _F = 10 mA	λ _P Peak emission wavelength (nm) ¹	V _R Reverse voltage (V)	I _R Reverse current (μA) at V _R = 3 V	T _{OP} Operating temperature (°C)	
LD 30 LD 32	85	min. 2,1 typ. 3,0 max.	20 25	1,8	700	5,0	100	- 40 + 85	
LD 34		min. 2,0 typ. 2,2 max.	20 40	20 ⁴	630			- 30 + 70	
LD 36 LDE 36 ³	100	min. 1,7 typ. 2,0 max.	20 50	20 30	660	4,0	100	- 30 + 85	
LD 40 LD 42		min. 2,1 typ. 3,0 max.	20 25	3,2	555			- 40 + 85	
LD 44	110	min. 2,0 typ. 2,1 max.	25 45	8 ⁴	565	4,0	10	- 30 + 70	
LD 46 LDE 46 ³		min. 2,1 typ. 2,5 max.	20 50	8 12	555			- 30 + 85	
LD 60 LD 62	85	min. 2,1 typ. 3,0 max.	20 25	2,7	600	5,0	100	- 40 + 85	
LD 64		min. 2,1 typ. 2,2 max.	35 50	10 ⁴	585			- 30 + 70	
LD 66 LDE 66 ³	125	min. 2,2 typ. 2,5 max.	20 50	16 24	580	4,0	100	- 30 + 85	
LD 70 LD 72		min. 2,7 typ. 3,0 max. 3,3	20 50	0,9 ⁴	470			5,0 30	- 20 + 80
LD 56	45	red } min. 2,1 typ. 3,0 max.	10 20	2,2	700	5,0	100	- 40 + 85	
		green } min. 2,1 typ. 3,0 max.	10 25	3,9	555			- 40 + 85	
		yellow } min. 2,1 typ. 3,0 max.	Combination red / green						
LD 96 flashing	200			0,5 ² 1,6 ²	660	0,4		- 40 + 70	

¹ with typical forward current

² at V_S = 5 V

³ Water proofing at 30 minutes at 1 m water column = IP 67.

⁴ at I_F = 20 mA

Models:

	Light colour	Housing
LD 30	red	
LD 40	green	brass
LD 60	yellow	chromium-plated
LD 70	blue	
LD 30 S	red	
LD 40 S	green	brass
LD 60 S	yellow	black, matt finish
LD 70 S	blue	

Dimensions

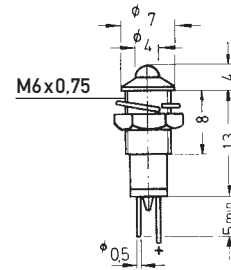

Also available with integrated resistor for 24 V operation.
Additional to type number: – 24

LD 32	red	
LD 42	green	brass
LD 62	yellow	chromium-plated
LD 72	blue	
LD 32 S	red	
LD 42 S	green	brass
LD 62 S	yellow	black, matt finish
LD 72 S	blue	

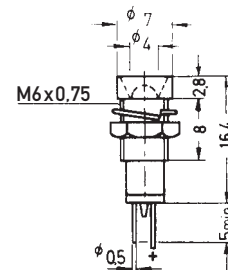

Also available with integrated resistor for 24 V operation.
Additional to type number: – 24

LD 34	red	
LD 44	green	brass
LD 64	yellow	chromium-plated
LD 34 S	red	
LD 44 S	green	brass
LD 64 S	yellow	black, matt finish

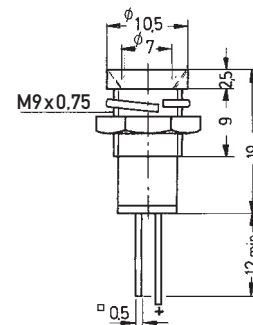

LD 36	red	brass	
LD 46	green	chromium-plated	superbright
LD 66	yellow		
LD 36 S	red	brass	superbright
LD 46 S	green	black, matt finish	
LD 66 S	yellow		

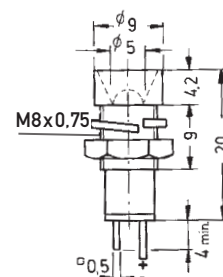

Also available with integrated resistor for 24 V operation.
Additional to type number: – 24



LED-Indicators

Models:

	Light colour	Housing	
LD 56	red/green/yellow	brass chromium-plated	tricoloured
LD 56 S	red/green/yellow	brass black, matt finish	tricoloured

Dimensions

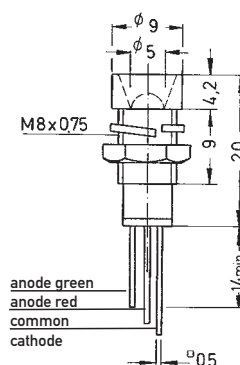

LD 96 R	red/red/red	brass	
LD 96 G	green/green/green	chromium-plated	flashing
LD 96 Y	yellow/yellow/yellow		
LD 96 SR	red/red/red	brass	
LD 96 SG	green/green/green	black, matt finish	flashing
LD 96 SY	yellow/yellow/yellow		

Flashing frequency = 3 Hz

Supply voltage = 4,75 V – 7 V

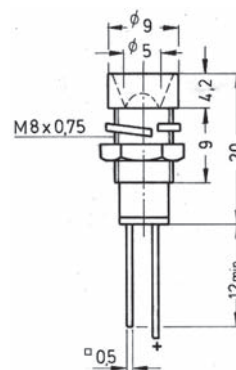

LDE 36	red	brass	
LDE 46	green	chromium-plated	waterproof
LDE 66	yellow		
LDE 36 S	red	brass	
LDE 46 S	green	black, matt finish	waterproof
LDE 66 S	yellow		

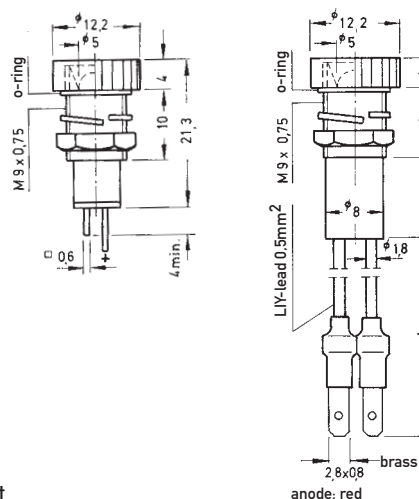

Special version: with lead and connector

Additional to type number: W

L = 50 mm; other length: minimum quantity and delivery time on request.

Also available with integrated resistor for 24 V operation.

Additional to type number: – 24

11

Membrane Keypads and Rubber Keypads

11.1 Membrane Keypads 212 – 213

11.2 Rubber Keypads 214 – 216

11.3 Inquiry Form 217 – 218

Membrane Keypad Structure



Reference Materials:

Overlay:	Polycarbonate Film (PC) – Matt or Glossy surface Thickness (mm): 0.075, 0.125, 0.175, 0.250, 0.375, 0.500 Polyester Film (PET) with UV-cured texture coating – Matt or Glossy surface Thickness (mm): 0.15, 0.20, 0.25
Circuit Layer:	Polyester Film (PET) – Thickness (mm): 0.075, 0.100, 0.125
Conductive:	Carbon Ink, Conductive Silver Paste or Metal Domes
Spacer:	Polyester Film (PET)
Adhesive:	Adhesive Double Tape

Standard Specification for Membrane Keypads:

Contact Resistance:	10 to 500 Ω
Operation Voltage:	< 35 V DC
Operation Current:	< 100 mA
Open Circuit Resistance:	> 10 M Ω
Operation Force:	30 g to 500 g
Operation Temperature:	-20 °C to +70 °C
Storage Temperature:	-20 °C to +70 °C
Life Expectancy:	5 x 10 ⁵ to 10 x 10 ⁵ cycles
Switch Stroke (travel):	0.1 mm to 0.6 mm
Contact Bounce:	5 to 30 mSec

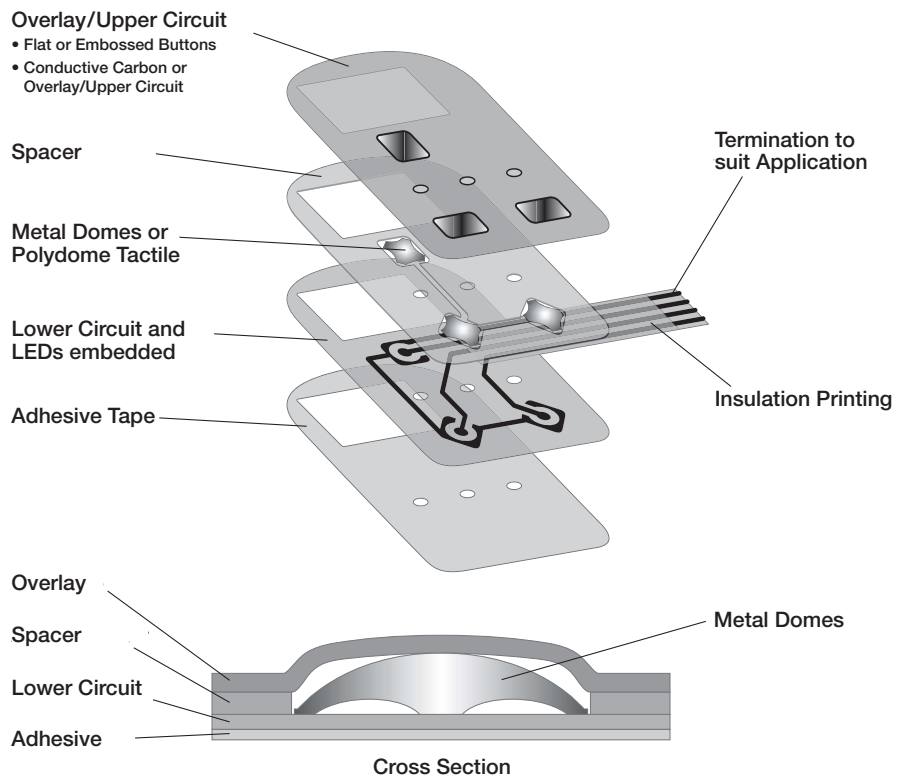



Membrane Switch Structure

Flat Type (Non-Tactile)

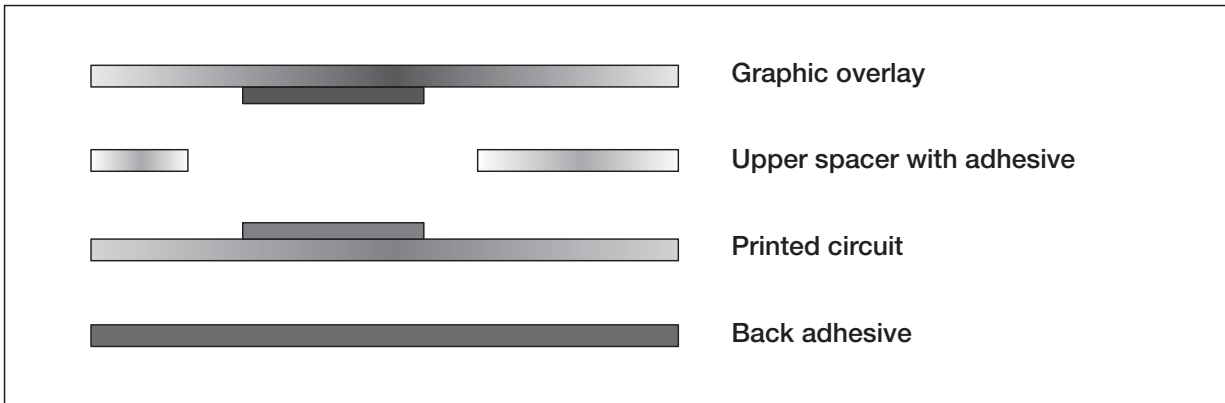

Tactile Type

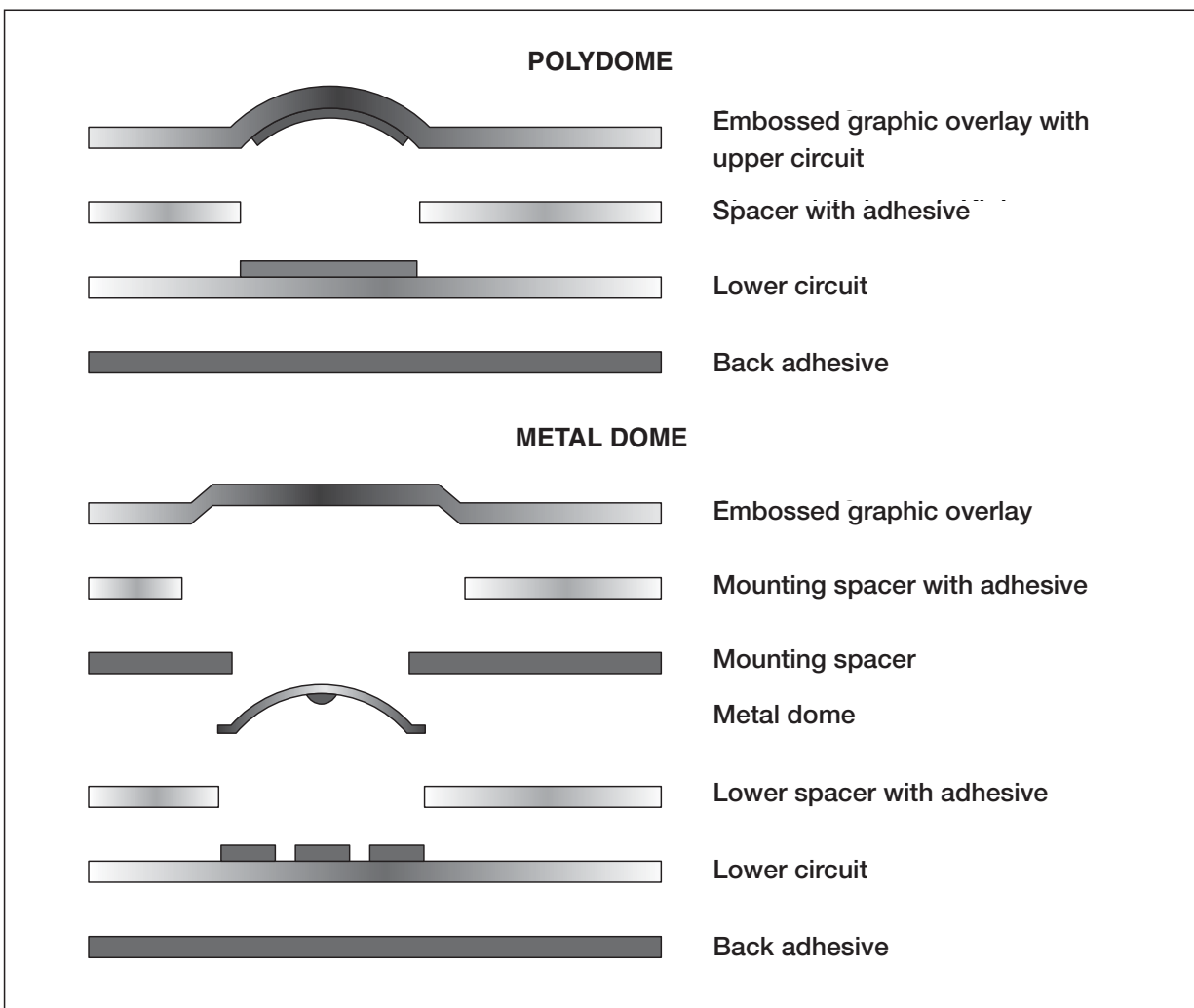

Rubber Keypad Design

Tolerance Requirement of Silicone Rubber Key:

Dimensions:

0 – 9 mm	± 0.10 mm
10 – 19 mm	± 0.15 mm
20 – 29 mm	± 0.20 mm
30 – 39 mm	± 0.25 mm
40 – 49 mm	± 0.30 mm
50 – 59 mm	± 0.35 mm
60 and above	± 0.6 %

Actuation Force:

50 – 60 grams	± 15 grams
61 – 80 grams	± 20 grams
81 – 100 grams	± 25 grams
101 – 120 grams	± 30 grams
121 – 150 grams	± 35 grams
151 – 200 grams	± 40 grams
201 and above	± 25 %

Mechanical and Electrical Properties of Silicone Rubber:

Temperature for use:	–55 °C to +250 °C
Specific Gravity:	1.15
Tensile Strength:	90 Kg/cm ²
Tear Strength:	13 Kgf/cm
Compression Set:	10% (180 °C x 22 hrs.)
Elongation at Break:	350%
Volume Resistivity:	8 x 10 ¹⁴ Ω cm
Insulation Breakdown:	24 Kv/mm
Colour:	Colouring possible
Dielectric Constant:	4.2 (50 Hz)
Dielectric Tangent:	13% (50 Hz)

Depending on the size of contacts and keyboard layout.

Non-Conductive Silicone

Force-Stroke Curve of Rubber Keypad

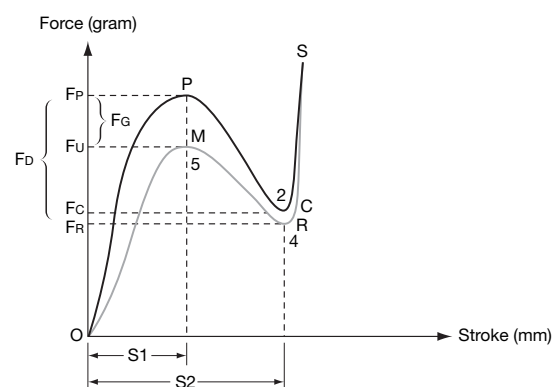

Force

Fp	Peak Force (Fmax)
Fu	Max. Return Force
Fc	Contact Force
Fr	Min. Return Force (Fmin)
Fm	Max. Return Force
Fd	Drop Force (Fd = Fp - Fc)
Fg	Gap Force (Fg = Fp - Fm)

Stroke

S1	Peak Stroke
S2	Contact Stroke

Location:

O	Original Point
P	Peak Point
C	Contact Point
R	Return Point
M	Max. Return Point

Travel

O-P	Peak Force (FMAX)
P-C	Contact Force
C-S	Min. Return Force (FMIN)
S-R-M-O	Gap Force (FG = Fp - Fm)

Basic Construction

Illustration:

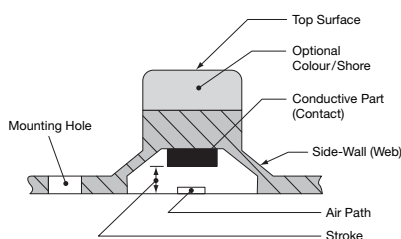

Life Test:

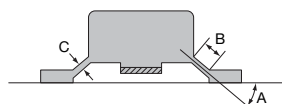

Operating life depends on:

- **Soft Material** ... 50 Shore is preferred.
- **Low Stroke** ... less than 1 mm
- **Angle** (as part A illustrated above) ... 40-degree is recommended.
- **Length of side-wall** ... (as part B illustrated above)
- **Thickness of side-wall** ... (as part C illustrated above) ... determined by key structure. The thicker the web, the higher the operating force.

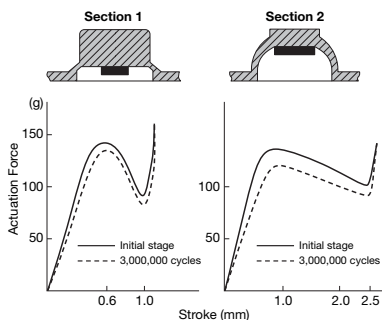



Rubber Keypad Design

Typical Key Sections and Characteristics:

Force Range: 30 ~ 350 grams
 Stroke Range: 0.5 ~ 3.0 mm
 Cycle Life (x10³): 500 ~ 2000
 Typical uses: Telephone, Remote Control, Automotive, Radio, Toys, Calculator, etc.

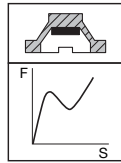

Force Range: 30 ~ 80 grams
 Stroke Range: 2.0 ~ 4.0 mm
 Cycle Life (x10³): 5000 ~ 20000
 Typical uses: Computer, Typewriter etc.

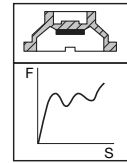

Force Range: 30 ~ 250 grams
 Stroke Range: 0.7 ~ 2.5 mm
 Cycle Life (x10³): 1000 ~ 3000
 Typical uses: Telephone, Remote Control, Toys, Games, Calculator, etc.

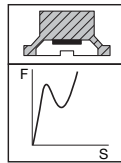

Force Range: 30 ~ 200 grams
 Stroke Range: 1.0 ~ 2.5 mm
 Cycle Life (x10³): 500 ~ 3000
 Typical uses: Telephone, Typewriter, Test Instruments, etc.

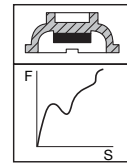

Force Range: 30 ~ 150 grams
 Stroke Range: 0.5 ~ 3.0 mm
 Cycle Life (x10³): 1000 ~ 3000
 Typical uses: Telephone, Remote Control, Toys, Measuring Instruments, Office Machine

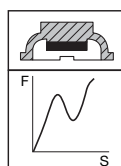

Force Range: 20 ~ 80 grams
 Stroke Range: 0.2 ~ 1.0 mm
 Cycle Life (x10³): 500 ~ 10000
 Typical uses: Typewriter, Household Appliances, Computer, etc.

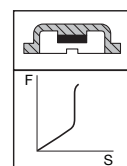

Some Special Design Illustrations:

1. Different shorehardnesses in the basic keypad and key

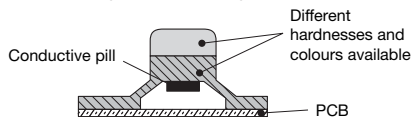

2. Push or pull thru to anchor keypad to PCB

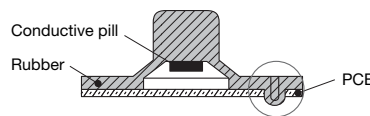

3. Back lighting – option 1

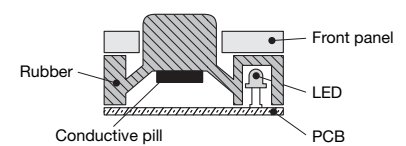

4. Squared key top design with LED light pipe

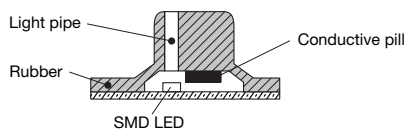

5. Back lighting – option 2

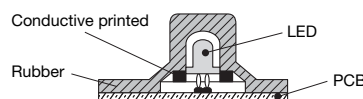

6. Control of travel distance

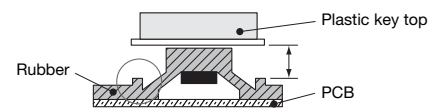

Special Design for Construction Ideas:

1. Typical outside radius is 1.0 mm to 1.5 mm.
2. Minimum radius is 0.3 mm.
3. Minimum inside radius is 0.2 mm.
4. Spacing between the edges of a rubber dome and a guide hole is 1.0 mm or more.
5. Guide holes are min. 1.0 mm in diameter.
6. The width of a rubber dome base is typically 2.0 mm more than a.
7. The minimum radius for the side edges of key top is 0.25 mm.
8. The minimum radius for the top edges of key top is 0.2 mm.

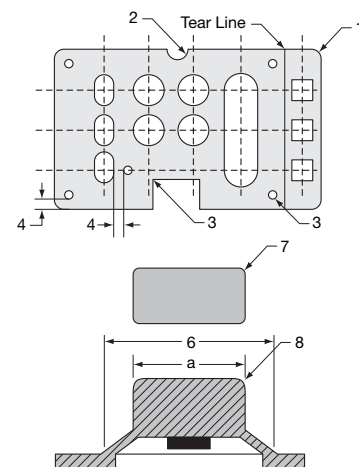

Rubber Keypad Design

Guideline for Assembly Design:

A & B: dimensions of plastic
a & b: dimensions rubber

$A-a \geq 0.5 \text{ mm}$, $B-b > 0.5 \text{ mm}$

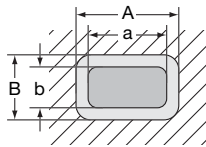

$D-d = 1.5 \text{ to } 2.0 \text{ mm}$

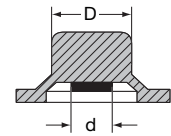

R: the corner radius of plastic
r: the corner radius of rubber

$1 \text{ mm} \leq R \leq 1.25 \text{ mm}$, $0.75 \text{ mm} \leq r \leq 1 \text{ mm}$ is better

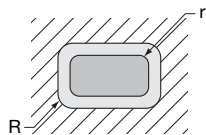

P: diameter of post
t: the gap between post & conductive pill
 $P = 1.0 \text{ mm}$ is better
 $t = 0.1 \sim 0.15 \text{ mm}$ is better

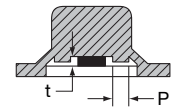

H: the dimension of key tops & plastic
S: the stroke of key pad

$H-S \leq 1.5 \text{ mm}$

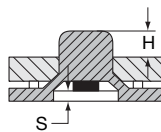

F_c : click force
 F_c : $F_1 - F_2 > 25 \text{ g}$ is better

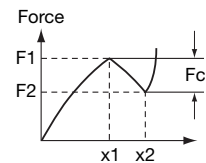

Guideline for Printing Artwork Design:

Button Graphics

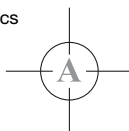

Graphics Off Centre $\pm 0.3 \text{ mm}$

Full Surface Printing

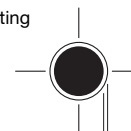

$\pm 0.5 \text{ mm}$
 0.5 mm

Patterns of Conductive Designs:

Items:

Circle:

Square/Ellipse:

Conductive Pill Resistance:

Mechanical Life:

Print type Resistance:

Mechanical Life:

Standard Sizes of Conductive Pill

1.5, 2, 2.5, 3, 3.5, 4, 4.5, 5, 6, 7, 8, 9, 10

Recommended size of conductive ink printing contact is flexible.

Less than 150 ohms, with 125 grams loading

minimum 10 million operations

Less than 500 ohms, with 125 grams loading

1×10^6 max. operations

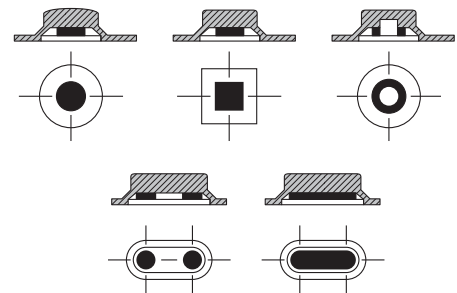

Colour/Printing:

Suitable Key Surface for Legend Printing:

The commonly used colour for the underlay is medium-grey. Customers should provide us with the Pantone code or a colour specimen for both the key button and the legend.

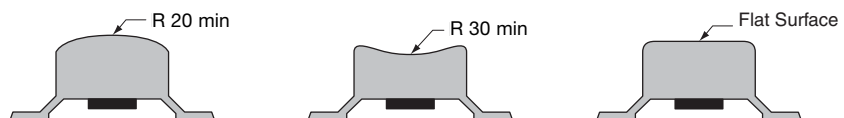

Keypads Inquiry Form

Company _____

Department _____

Attention _____

Address _____

Postcode _____

Phone _____ Fax _____

Email _____ Web _____

Membrane Requirements

Graphic Layer

Overall size _____

What finish is required (matt, gloss or selective texture) _____

Are windows required _____

Size _____

Position _____

Do they need to be tinted _____

Is embossing required _____

Pillow or rim _____

Number of colours _____

Switches

Number _____

Tactile or non-tactile _____

If tactile: polydome or metal dome _____

*Metal means higher unit cost, lower tool cost.
Polydome means lower unit cost, higher tool cost.*

Detail of switch matrix _____

LEDs

Are embedded LEDs required _____

Number and colour _____

Will a separate tail be required _____

Tail position and length

Position of tail – exit from side and rear _____

Type of connector (if required) _____

If ZIF connector being used, get type for ref. _____

Any special features required

Insert legends _____

Luminescent inks _____

Other _____

Estimated project volume

Please complete this questionnaire and return to us with your sketch overleaf
(See back page for address details)



Layout Inquiry

A large grid of 30 columns and 30 rows, intended for sketching a keypad layout.

Please sketch out your keypad layout and return to us
(See back page for address details)



Product Index alphabetical

Models	Page	Models	Page
APE	46-47	MRS	171-174
ASE	102	MSP	41-43
ASL	103	MSS	106-107
ATE	22-24	MTA	12-13
DBP	137, 150	MTE	14-15
DBS	132, 140-141, 145, 147-148	MTG	18-19
DHS	138-139	MTL	16-17
DM-DM	203	MTW	20
DM-SM	198-200	MZME	21
DM-SSM	204	MZP	48
DM-SW	201-202		
DM-VMS	195-197	PLSJ	90
DPL	57		
DPW	53-56	Rubber Keypads	214-216
DPWL	54-56		
DRR	154, 156, 158, 160	SBP	136, 151
DRS	154, 156, 158, 160, 162, 164, 166	SBS	133, 142-144, 146
DSS	130-131, 134	SMR	155, 157, 159, 161, 163, 175
FP	50-51	SMRR	161
FT	28-29	SMS	135
LD	LEDs 206-209	SSP	49, 52
LP	60-62	SST	25
LTM	66-67	STM	10-11
LTR	66-67		
MAV	70-71	TM	59, 64
Membrane Keypads (YFT)	212-213	TME	81
MEOP	180	TMP	72
MER	181-191	TMPS	73
MERP	182, 184-189	TMS	80
MFP	104-105, 108-118	TMSE	80, 89
MFS	104-105, 119	TMV	194
MMP	120-122, 126-127	TP	68
MMS	124-126	TR	64
MMSP	123	TS	83, 87-88, 91, 94
MPA	32-33	TSE	74-75, 78, 85
MPBS	44	TSJ	99
MPE	34-35	TSP	49
MPG	36-37	TSS	82, 86, 90-95
MPLS	58	TSSE	76-77, 79, 84, 92
MPME	40	TSSJ	97-100
MPS	38	TSSL	63
MPSA	45	TST	26-27
MR	170		
MRK	176-177		
MRP	192		

knitter-switch
elektrotechnische erzeugnisse · Knitter & Co. KG

D-85593 Baldham · Postfach 10 02 33 · Neue Poststrasse 17
Tel.: +49 (0) 81 06 / 36 21-0 · Telefax: +49 (0) 81 06 / 36 21 40
E-Mail: info@knitter-switch.com · www.knitter-switch.com

knitter-switch
Succursale France

F-91400 ORSAY · Parc Club Orsay Université · 18 rue Jean Rostand
Téléphone: +33 (0) 1/69 33 11 60 · Télécopie: +33 (0) 1/69 33 11 80
E-Mail: ksfrance@knitter-switch.com · www.knitter-switch.com

knitter-switch
UK Limited

GB-Basingstoke Hants RG24 8AG · Grove House, Lutyens Close
Chineham Court · Phone: +44 (0) 12 56/33 86 70 · Fax: +44 (0) 12 56/33 86 71
E-Mail: ksuk@knitter-switch.com · www.knitter-switch.com

knitter-switch
Office Scandinavia

DK-4872 Idestrup · Østersøvej 6
Phone: +45 (0) 6913 7787 · Fax: +45 (0) 8175 7787
E-Mail: j.hansen@knitter-switch.com · www.knitter-switch.com

knitter-switch
ASIA Limited

Hong Kong B9-10, 1/F, Block B, Proficient Industrial Centre
6 Wang Kwun Road, Kowloon Bay, Kowloon
Tel: +852 23 11 87 99 · Fax: +852 23 11 87 39
E-Mail: ksasia@knitter-switch.com · www.knitter-switch.com