

A92 TRANSISTOR(PNP)

FEATURE

- High voltage



Package TO-92

MAXIMUM RATINGS* ($T_a=25^{\circ}\text{C}$ unless otherwise noted)

Parameter	Symbol	Value	UNIT
Collector-Base Voltage	V_{CBO}	-310	V
Collector-Emitter Voltage	V_{CEO}	-305	V
Emitter-Base Voltage	V_{EBO}	-5	V
Collector Current - Continuous	I_C	-200	mA
Collector Current - Pulsed	I_{CM}	-500	mA
Collector Power Dissipation	P_C	625	mW
Thermal Resistance From Junction to Ambient	$R_{\theta JA}$	200	$^{\circ}\text{C}/\text{mW}$
Thermal Resistance From Junction to Case	$R_{\theta JC}$	83.3	$^{\circ}\text{C}/\text{mW}$
Junction Temperature	T_J	150	$^{\circ}\text{C}$
Junction and Storage Temperature	T_{stg}	-55~+150	$^{\circ}\text{C}$

*These ratings are limiting values above which the serviceability of any semiconductor device may be impaired.

ELECTRICAL CHARACTERISTICS ($T_a=25^{\circ}\text{C}$ unless otherwise specified)

Parameter	Symbol	Test conditions	MIN	TYP	MAX	UNIT
Collector-base breakdown voltage	$V_{(BR)CBO}$	$I_C=-100\mu\text{A}, I_E=0$	-310			V
Collector-emitter breakdown voltage	$V_{(BR)CEO}$	$I_C=-1\text{mA}, I_B=0$	-305			V
Emitter-base breakdown voltage	$V_{(BR)EBO}$	$I_E=-100\mu\text{A}, I_C=0$	-5			V
Collector cut-off current	I_{CBO}	$V_{CB}=-200\text{V}, I_E=0$			-0.25	μA
Emitter cut-off current	I_{EBO}	$V_{EB}=-5\text{V}, I_C=0$			-0.1	μA
DC current gain	$h_{FE(1)}$	$V_{CE}=-10\text{V}, I_C=-1\text{mA}$	60			
	$h_{FE(2)}$	$V_{CE}=-10\text{V}, I_C=-10\text{mA}$	80		250	
	$h_{FE(3)}$	$V_{CE}=-10\text{V}, I_C=-80\text{mA}$	60			
Collector-emitter saturation voltage	$V_{CE(sat)}$	$I_C=-20\text{mA}, I_B=-2\text{mA}$			-0.2	V
Base-emitter saturation voltage	$V_{BE(sat)}$	$I_C=-20\text{mA}, I_B=-2\text{mA}$			-0.9	V
Transition frequency	f_T	$V_{CE}=-20\text{V}, I_C=-10\text{mA}, f=30\text{MHz}$	50			MHz

CLASSIFICATION OF $h_{FE(2)}$

Rank	A	B	C
Range	80-100	100-200	200-250

TYPICAL CHARACTERISTICS

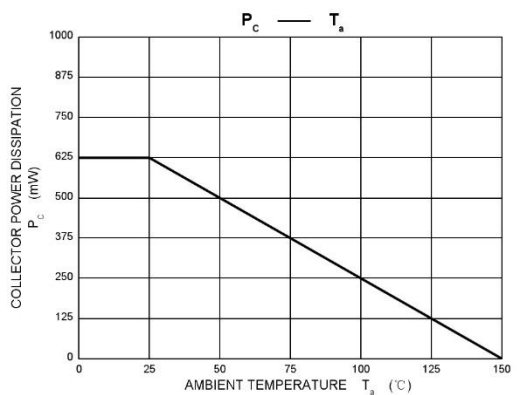
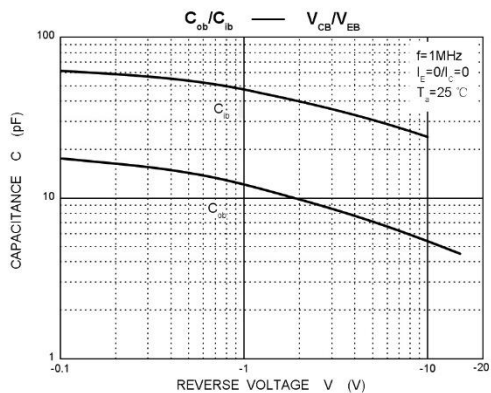
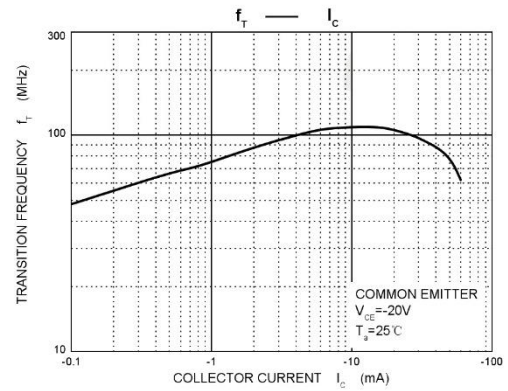
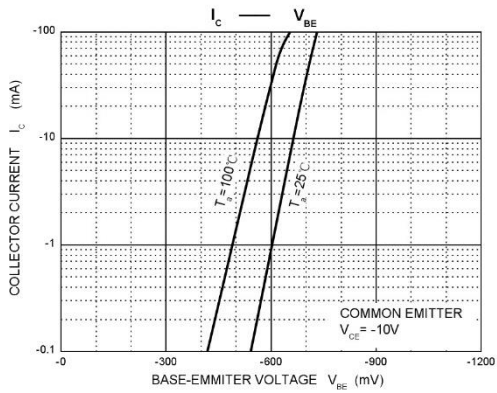
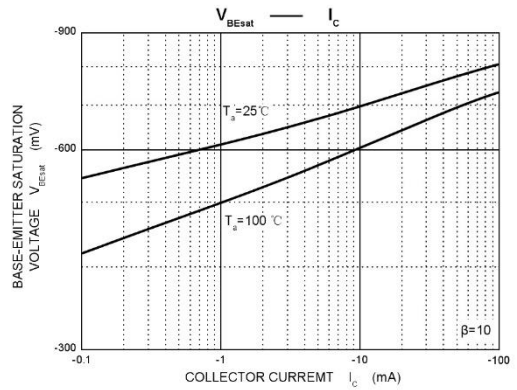
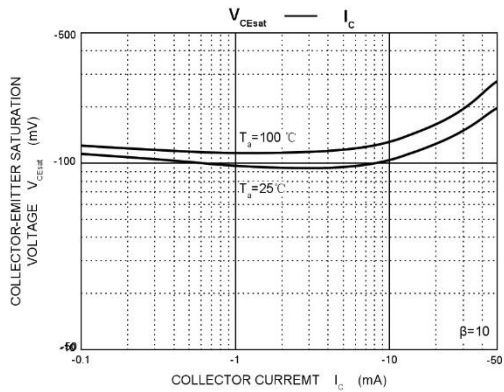
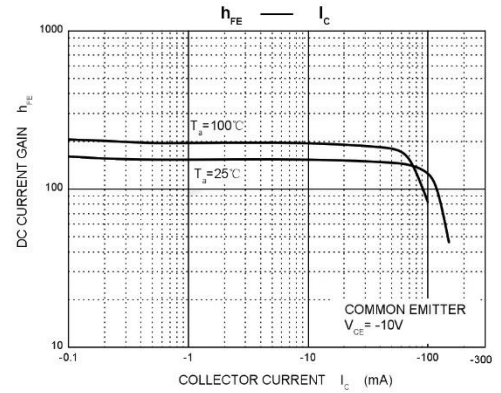
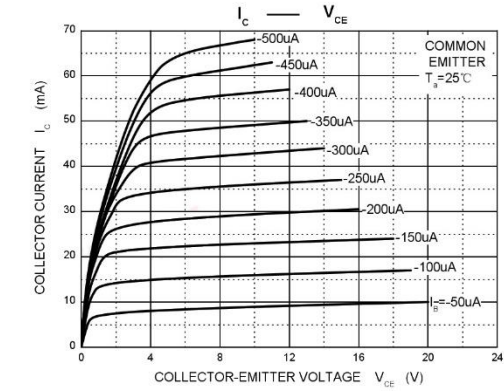

All products, product specifications and data are subject to change without notice to improve reliability, function or design or otherwise.

TO-92 Package Outline Dimensions

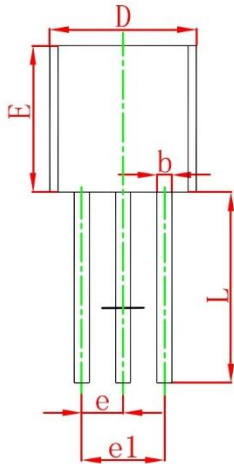
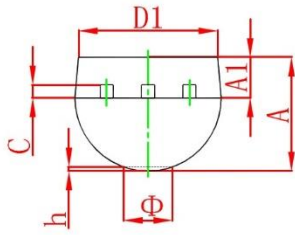

Symbol	Dimensions In Millimeters		Dimensions In Inches	
	Min	Max	Min	Max
A	3.300	3.700	0.130	0.146
A1	1.100	1.400	0.043	0.055
b	0.380	0.550	0.015	0.022
c	0.360	0.510	0.014	0.020
D	4.300	4.700	0.169	0.185
D1	3.430		0.135	
E	4.300	4.700	0.169	0.185
e	1.270 TYP		0.050 TYP	
e1	2.440	2.640	0.096	0.104
L	14.100	14.500	0.555	0.571
Φ		1.600		0.063
h	0.000	0.380	0.000	0.015

TO-92 Suggested Pad Layout

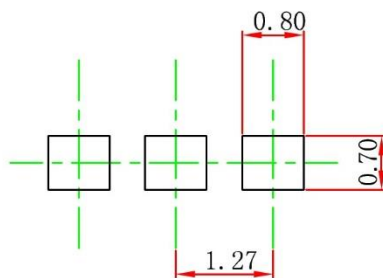

Note:

1. Controlling dimension: in millimeters.
2. General tolerance: $\pm 0.05\text{mm}$.
3. The pad layout is for reference purposes only.

TO-92 Tape and Reel

TO-92 PACKAGE TAPEING DIMENSION

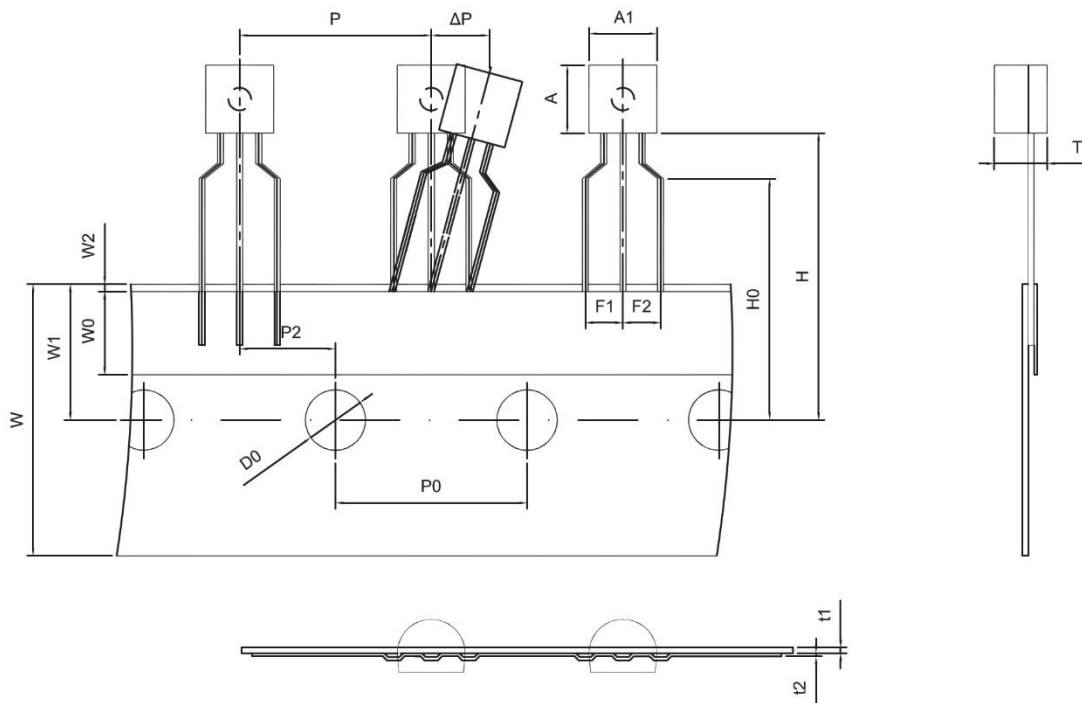

Dimensions are in millimeter

A1	A	T	P	P0	P2	F1	F2	W
4.5	4.5	3.5	12.7	12.7	6.35	2.5	2.5	18.0
W0	W1	W2	H	H0	D0	t1	t2	ΔP
6.0	9.0	1.0 MAX.	19.0	16.0	4.0	0.4	0.2	0

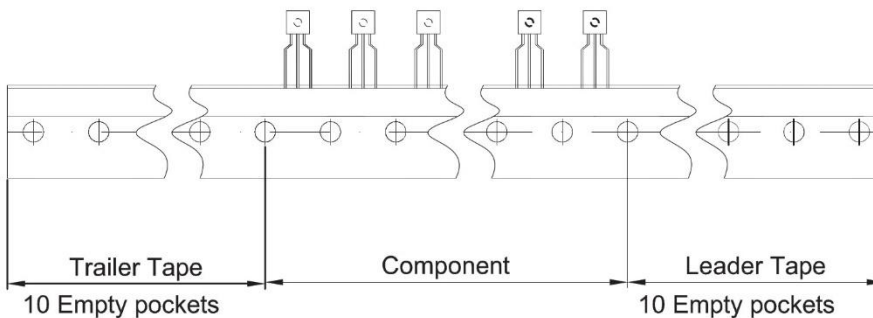

Package	Box	Box Size(mm)	Carton	Carton Size(mm)
TO-92	2000 pcs	333×162×43	20,000 pcs	350×340×250

All products, product specifications and data are subject to change without notice to improve reliability, function or design or otherwise.