

## 2N2907A TRANSISTOR(PNP)

### FEATURE

Complementary NPN Type available (2N2222A)



Package TO-92

### MAXIMUM RATINGS\* ( $T_a=25^{\circ}\text{C}$ unless otherwise noted)

Parameter	Symbol	Value	UNIT
Collector-Base Voltage	$V_{CBO}$	-60	V
Collector-Emitter Voltage	$V_{CEO}$	-60	V
Emitter-Base Voltage	$V_{EBO}$	-5	V
Collector Current - Continuous	$I_C$	-0.6	A
Collector Power Dissipation	$P_C$	0.625	W
Junction Temperature	$T_J$	150	$^{\circ}\text{C}$
Junction and Storage Temperature	$T_{stg}$	-55~+150	$^{\circ}\text{C}$

\*These ratings are limiting values above which the serviceability of any semiconductor device may be impaired.

### ELECTRICAL CHARACTERISTICS ( $T_{amb}=25^{\circ}\text{C}$ unless otherwise specified)

Parameter	Symbol	Test conditions	MIN	TYP	MAX	UNIT
Collector-base breakdown voltage	$V_{(BR)CBO}$	$I_C=-10\mu\text{A}, I_E=0$	-60			V
Collector-emitter breakdown voltage	$V_{(BR)CEO}$	$I_C=-10\text{mA}, I_B=0$	-60			V
Emitter-base breakdown voltage	$V_{(BR)EBO}$	$I_E=-10\mu\text{A}, I_C=0$	-5			V
Collector cut-off current	$I_{CBO}$	$V_{CB}=-50\text{V}, I_E=0$			-10	nA
Collector cut-off current	$I_{CEX}$	$V_{CE}=-30\text{V}, V_{EB(OFF)}=-0.5\text{V}$			-50	nA
Emitter cut-off current	$I_{EBO}$	$V_{EB}=-3\text{V}, I_C=0$			-10	nA
DC current gain	$h_{FE(1)}$	$V_{CE}=-10\text{V}, I_C=-0.1\text{mA}$	78			
	$h_{FE(2)}$	$V_{CE}=-10\text{V}, I_C=-150\text{mA}$	100		300	
	$h_{FE(3)}$	$V_{CE}=-10\text{V}, I_C=-500\text{mA}$	52			
Collector-emitter saturation voltage	$V_{CE(sat)}$	$I_C=-150\text{mA}, I_B=-15\text{mA}$			-0.4	V
	$V_{CE(sat)}$	$I_C=-500\text{mA}, I_B=-50\text{mA}$			-0.67	V
Base-emitter saturation voltage	$V_{BE(sat)}$	$I_C=-150\text{mA}, I_B=-15\text{mA}$			-1	V
	$V_{BE(sat)}$	$I_C=-500\text{mA}, I_B=-50\text{mA}$			-1.2	V
Transition frequency	$f_T$	$V_{CE}=-20\text{V}, I_C=-50\text{mA}, f=100\text{MHz}$	200			MHz
Delay time	$T_D$	$V_{CC}=-30\text{V}, I_C=-150\text{mA},$			10	ns
Rise time	$T_R$	$I_{B1}=-15\text{mA}$			25	ns
Storage time	$T_{stg}$	$V_{CC}=-6\text{V}, I_C=-150\text{mA},$			225	ns
Fall time	$T_F$	$I_{B1}=I_{B2}=-15\text{mA}$			60	ns

### CLASSIFICATION OF $h_{FE(2)}$

Rank	L	H
Range	100-200	200-300

TYPICAL CHARACTERISTICS

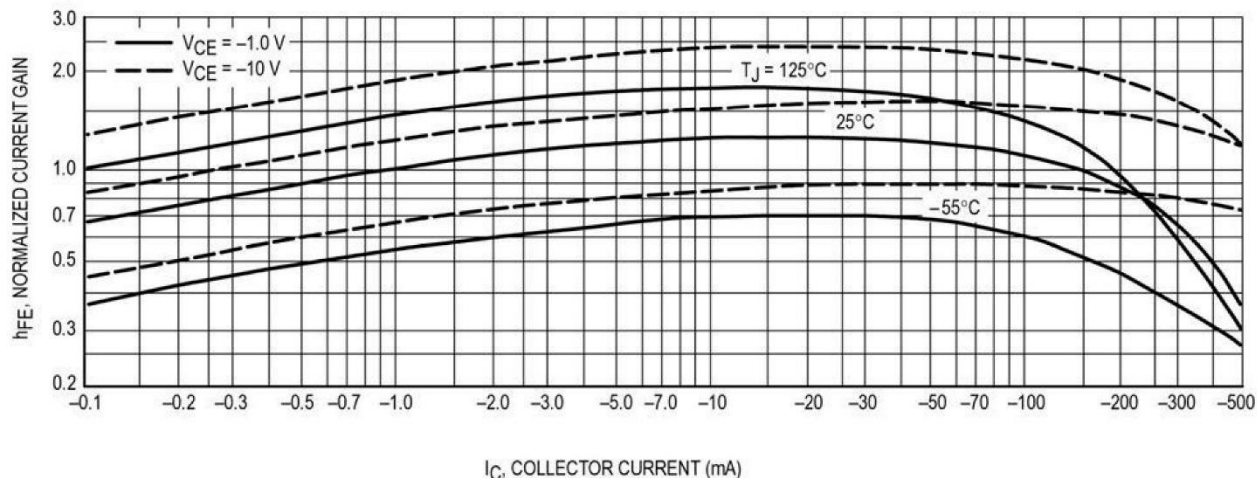

DC Current Gain

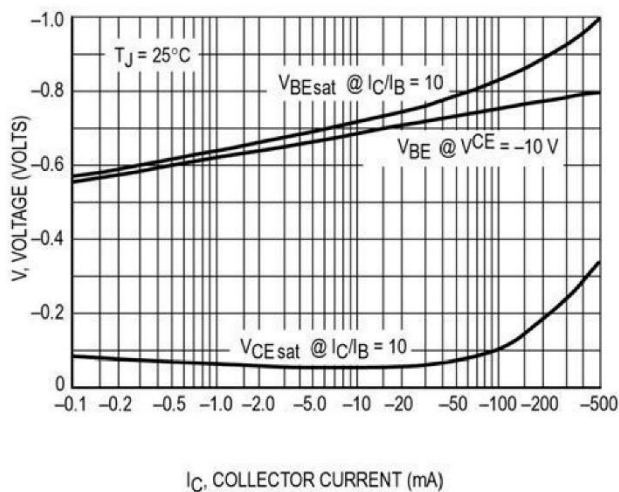

“On” Voltage

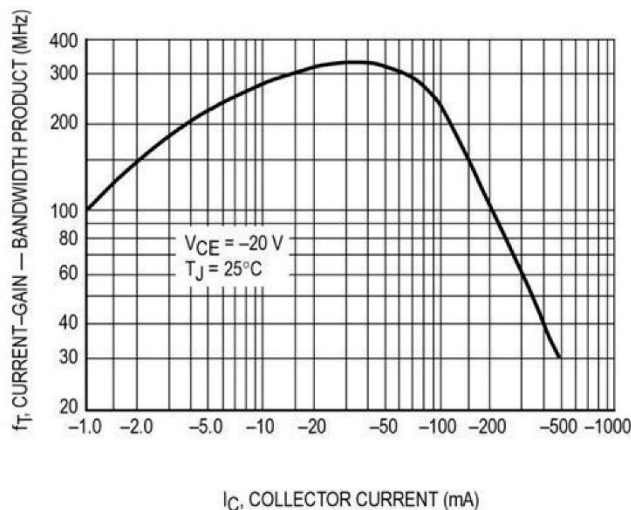

Current-Gain—Bandwidth Product

### TO-92 Package Outline Dimensions

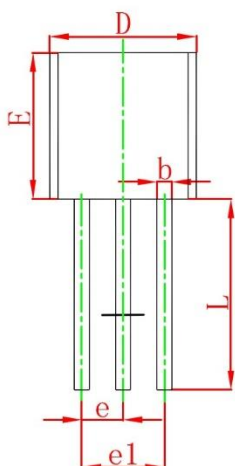
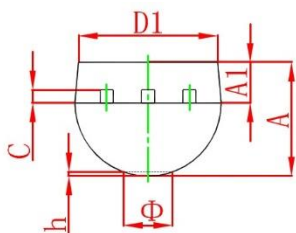

Symbol	Dimensions In Millimeters		Dimensions In Inches	
	Min	Max	Min	Max
A	3.300	3.700	0.130	0.146
A1	1.100	1.400	0.043	0.055
b	0.380	0.550	0.015	0.022
c	0.360	0.510	0.014	0.020
D	4.300	4.700	0.169	0.185
D1	3.430		0.135	
E	4.300	4.700	0.169	0.185
e	1.270 TYP		0.050 TYP	
e1	2.440	2.640	0.096	0.104
L	14.100	14.500	0.555	0.571
Φ		1.600		0.063
h	0.000	0.380	0.000	0.015

### TO-92 Suggested Pad Layout

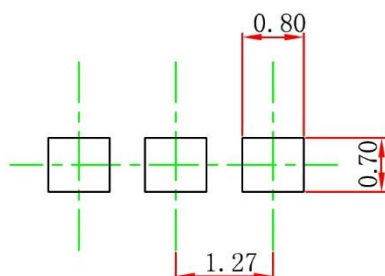

Note:

1. Controlling dimension: in millimeters.
2. General tolerance:  $\pm 0.05\text{mm}$ .
3. The pad layout is for reference purposes only.

**TO-92 Tape and Reel**

TO-92 PACKAGE TAPEING DIMENSION

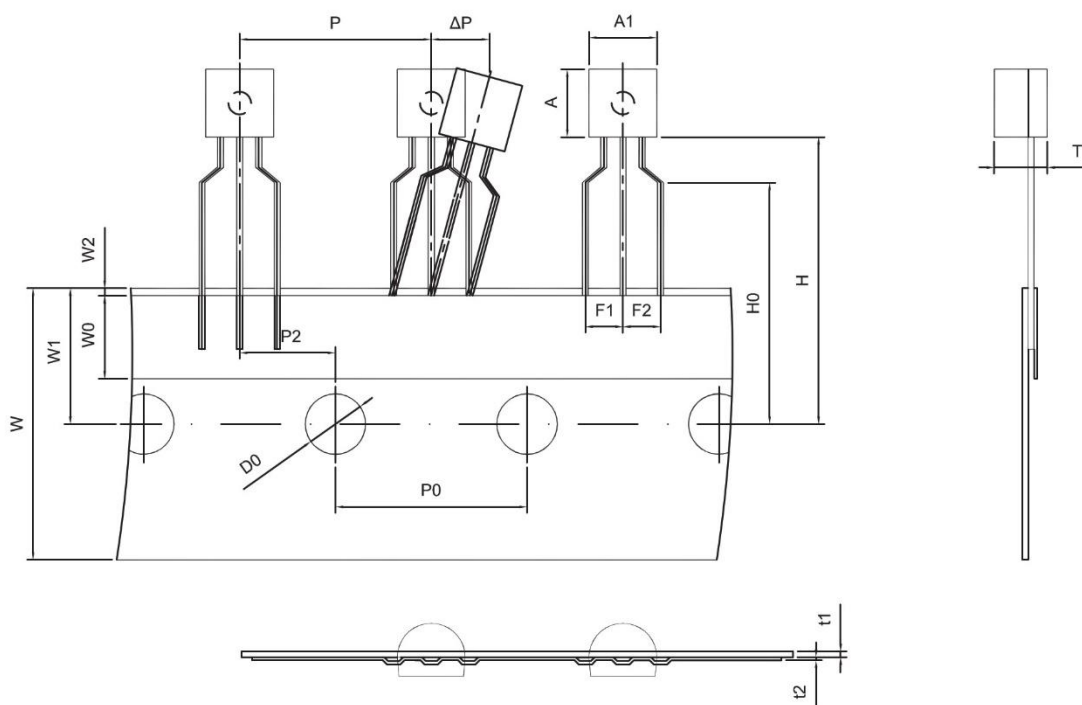

Dimensions are in millimeter

A1	A	T	P	P0	P2	F1	F2	W
4.5	4.5	3.5	12.7	12.7	6.35	2.5	2.5	18.0
W0	W1	W2	H	H0	D0	t1	t2	ΔP
6.0	9.0	1.0 MAX.	19.0	16.0	4.0	0.4	0.2	0

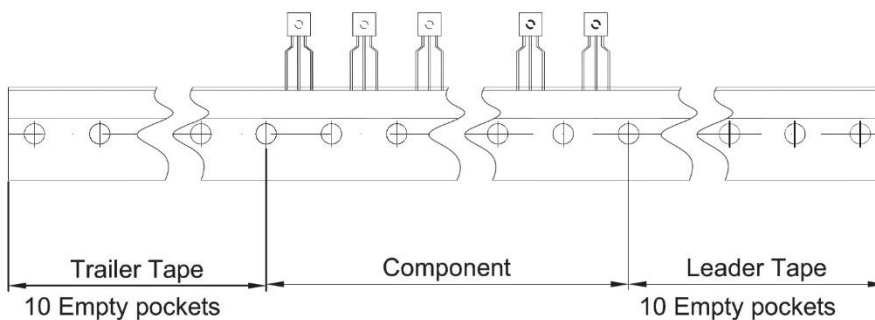

Package	Box	Box Size(mm)	Carton	Carton Size(mm)
TO-92	2000 pcs	333×162×43	20,000 pcs	350×340×250