

Data Sheet – SFM3100

Low Pressure Drop Analog Flow Meter

- Analog output
- Compact design
- Flow range: -24 ... 240 slm
- Direct gas temperature measurement
- Fully calibrated & temperature compensated
- Very fast response time



Product Summary

The SFM3100 sensor is Sensirion's flow meter designed for the mass flow measurement in ventilators. It measures the flow rate of **air, oxygen and non-aggressive gases** with superb accuracy. A special design of the flow channel results in the very low pressure drop through the flow body of the sensor making it extremely suitable for medical ventilation and respiratory applications.

The SFM3100 operates from a 5 V supply voltage and features an **analog interface**. The signal is internally processed and **temperature compensated**.

The outstanding performance of these sensors is based on Sensirion's **patented CMOSens® sensor technology**, which combines a thermal sensor element, signal processing and digital calibration on a single microchip. This assures **very fast signal processing**. An additional temperature sensor provides a highly **accurate temperature measurement in the gas stream**.

The well-proven CMOS technology is perfectly suited for high-quality mass production and is the ideal choice for demanding and cost-sensitive OEM applications.

Applications

- Ventilation
- Anesthesia
- Inspiratory flow sensing
- Gas mixing

OEM options

A variety of custom options can be implemented for high-volume OEM applications (digital interface, custom flow rates, calibration for other gases, different body form factor etc.). Contact us for more information.

Sensor electronics

The SFM3100 flow meter features a fifth-generation silicon sensor chip and provides an analog output signal. An EEPROM is included to store sensor specific information such as the serial number or customer specific data. See chapter 2.3 for more detail.

Direct gas temperature measurement

The SFM3100 is equipped with an NTC element centrally positioned in the main flow channel for direct temperature measurement of the gas.

1. Sensor Performance

1.1 Physical specifications ¹

Parameter	Condition	Value		Unit
Flow Ranges	Air	-24 ... +240		slm ²
		Typ. ³	Max. ⁴	
Accuracy Flow ^{5,6,7}	span (< 60 slm)	2.5	3	% m.v. ⁸
	span (< 150 slm)	3.5	4	% m.v. ⁸
	span (< 240 slm)	4.5	6	% m.v. ⁸
	offset	0.02	0.03	slm ²
Resolution Flow (analog signal)	span	0.05	0.07	% m.v.
	offset	0.04	0.045	slm ²
Noise Level ^{6,9}	span (<60 slm)	0.5	1	% m.v. ⁸
	span (<150 slm)	1	2	% m.v. ⁸
	span (<240 slm)	2	3	% m.v. ⁸
	offset	0.045	0.05	slm
Accuracy Shift Due to Temperature Variation ¹⁰	Span	0.4	0.5	% m.v. /10°C
	offset	0.015	0.02	slm /10°C
Pressure Drop	@60slm	< 300 / < 1.2	< 350 / < 1.4	Pa / inH ₂ O
	@200slm	< 1600 / < 6.4	< 1800 / < 7.2	
Accuracy Temperature	0 °C - 80 °C		2.5	°C
	-20 °C - 0 °C		4	°C
Resolution Temperature	analog signal	< 0.5°C ≈ 5mV/°C		

¹ Unless otherwise noted, all sensor specifications are valid at 25°C with Vdd = 5V and absolute pressure = 966 mbar and horizontal flow direction

² slm: mass flow measured in liters per minute at standard conditions (T = 20 °C, p = 1013.25 mbar)

³ for "Typ" a CpK of 0.67 is targeted (95% of sensors within the Typ limit)

⁴ for "Max" no sensor measured outside of this limits will be shipped and a CpK of 1.33 is targeted

⁵ Including offset, non-linearity, hysteresis

⁶ Total accuracy/noise level/resolution is a sum of offset and span accuracy/noise level/resolution

⁷ The accuracy is valid for T(gas)=T(Chip)

⁸ %m.v. = % measured value = % of reading

⁹ noise level defined as standard deviation of individual sensor readings, measured at full sampling rate (typ: average of noise level ; max: at least 99.99% of sensors have a noise level below indicated value)

¹⁰ these effects need to be added to the initial values if applicable

1.2 Ambient conditions

Parameter	Condition	Value	Unit
Calibrated Temperature Range	dry air	+5 ... +60	°C
Operating Temperature Range	10-95% rel. hum. (non cond.)	+5 ... +60	°C
Storage Temperature	0-100% rel. hum. (non cond.)	-25 ... +65	°C
Operating Pressure Range	absolute	0.6 ... 1.07	bar
Operating Overpressure	gauge	0 ... 0.1	bar
Burst Overpressure	gauge	>1000	mbar

1.3 Media compatibility

Parameter	Value
Calibration	Air
Media Compatibility	Air (non-condensing), N ₂ , O ₂ , other non-aggressive gases
Wetted Materials	PPE+PS blend, Si, Si ₃ N ₄ , SiO _x , Gold, Epoxy, Polyimide, silicone, stainless steel, FKM
RoHS, REACH	RoHS and REACH compliant

2. Electrical Specifications

2.1 Block diagram

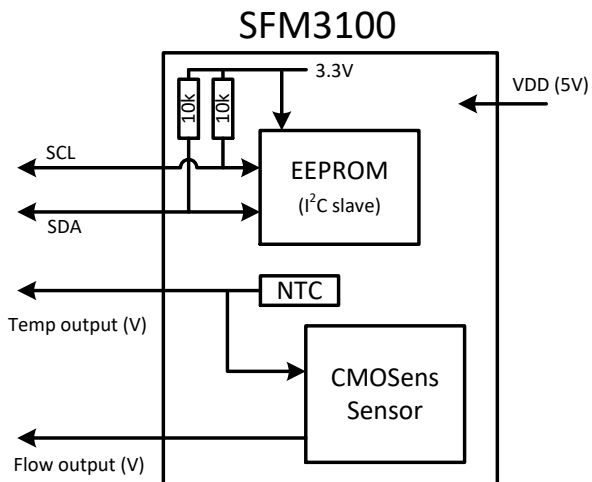

2.2 Electrical characteristics

Electrical properties	Condition	Value			Unit
		Min.	Typ.	Max.	
Supply voltage (VDD)		4.75	5	5.25	V
Start-up Time ¹¹				200	ms
Power Consumption				150	mW
Flow output signal	range	0.095		2.45	V
Temperature output signal	range	0.2		2.4	V
EEPROM I ² C communication level	High	2.5	3.3	4.3	V
	Low	GND		0.8	V
Output capacitive load C _{load}				100	nF
Output resistive load R _{load}		10			kΩ

¹¹ After 4.75V is reached

2.3 EEPROM

The SFM3100 has an on-board EEPROM, which can be accessed over the I²C interface.

The EEPROM is read-only and stores sensor specific information such as the serial number or customer specific data as well as correction factors for measurements with O₂ or O₂ mixtures.

The chip enable (E2) of the EEPROM is connected to ground so that the device address of the EEPROM starts with 0b10100. The device address has the following format:

B7	B6	B5	B4	E2	A9	A8	R/W	A7	A6	A5	A4	A3	A2	A1	A0
1	0	1	0	0	x	x	1/0	x	x	x	x	x	x	x	x

where the green bits (B7-E2) are fixed and the yellow bits (A9-A0) contain the byte address within the EEPROM memory. The R/W bit depends on the read operation mode as explained in the section 5.2 of the EEPROM datasheet.

Byte Address within EEPROM (bits A9-A0)	Content
0x002-0x007	Product number (a-bbbbb-bb-cc) a: 0xA002 bbbbbb: 0xA003-0xA006 cc: 0xA007
0x00A-0x011	Serial number MSB: 0xA00A

The EEPROM is the M24C08-WDW6TP from ST Microelectronics. For more details please refer to the datasheet on the ST.com website.

2.4 Pin layout and mechanical concept of the electrical connection

Pin	Description	Pin	Description
1	Flow signal	2	Connect to GND, Pin 9
3	Temperature signal	4	Analog GND
5	EEPROM SCL	6	EEPROM SDA
7	Not connected	8	VDD (5V)
9	Power Supply GND	10	Not connected

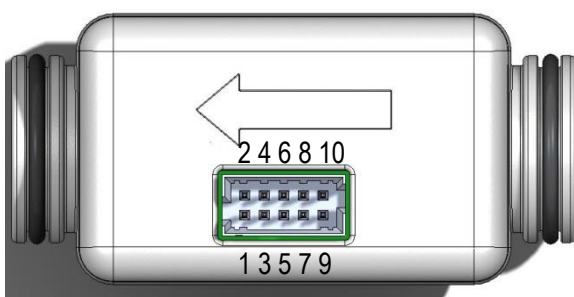

The SFM3100 is designed for connector attachment and uses Molex Milli-Grid 87831-1041 (THT). Please refer to the datasheet of this part for mating connectors.

3. Conversion to Physical Values

3.1 Air flow calculation

In order to obtain the flow in slm from the voltage flow signal, the measured value ($U[V]$) needs to be converted using the following formula:

$$Q[\text{slm}] = \left(U[V] - \frac{\text{Offset}}{B} \right) \cdot \frac{A}{B} \cdot \text{abs} \left(U[V] - \frac{\text{Offset}}{B} \right)$$

$$= (U[V] - 0.67V) \cdot 80 \frac{\text{slm}}{V^2} \cdot \text{abs}(U[V] - 0.67V)$$

The factors A, B and Offset are stored on the EEPROM. Please refer to Appendix B, formula (1).

For a flow smaller than -24.2 slm the sensor output is fixed at 0.095 V. Similarly, for flows above 240 slm the output voltage is set to 2.45 V.

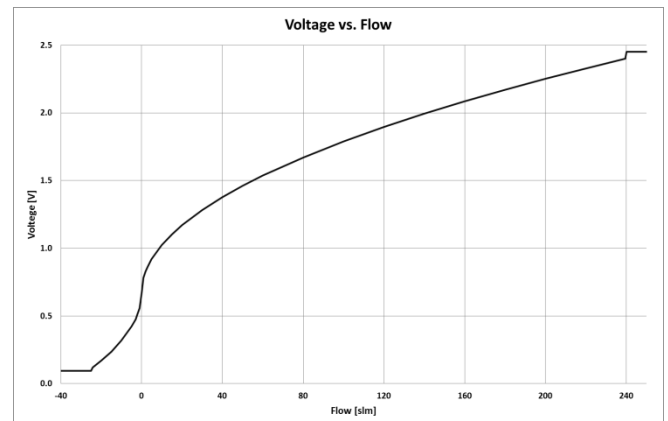

In order to obtain the measured temperature in °C, use the table attached in Appendix A or the following graph:

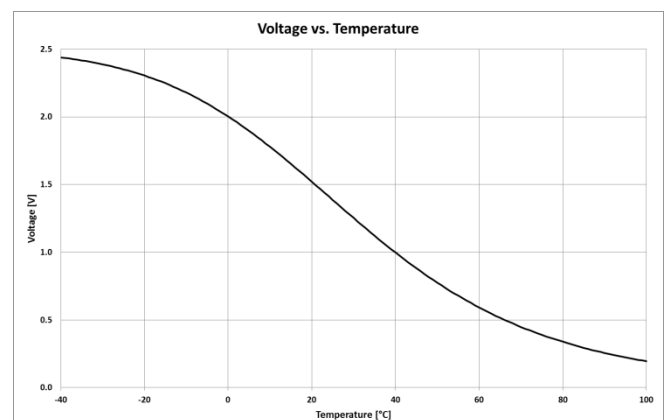

Please note that the first measurement performed directly after chip initialization is not valid.

4. Mechanical Specifications

All dimensions are in millimetres (mm).

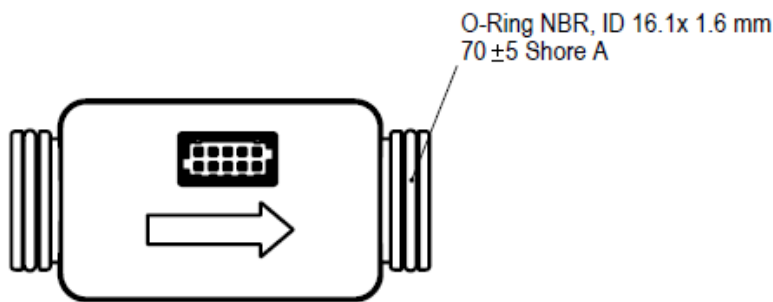
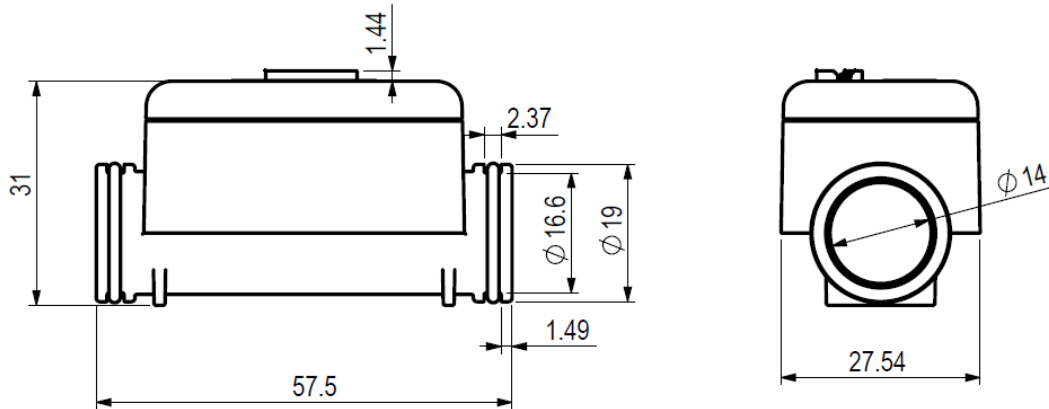

5. Instructions for Use

5.1 Calibration orientation

The sensors are calibrated horizontally as depicted in the following graph:

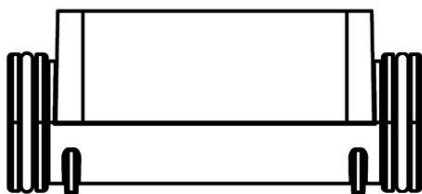

5.2 Inlet flow conditions

In order to provide good flow conditions, the inner diameter of the connecting tube has to be the same as the inner diameter of the SFM3100 main flow channel (16.6mm). The

3.2 O₂ flow calculation

To measure oxygen flow a conversion function needs to be applied. Please refer to Appendix B.

inlet tube is recommended to be straight and at least 10 cm in length. The SFM3100 is equipped with a mesh on the inlet of the flow channel to improve flow conditions.

Please refer to the application note "Inlet conditions for the SFM3000 Mass flow meters" for more information.

5.3 Sensor handling

The packaging method of the CMOSens chip together with the inert housing and the sealing materials ensure a tight and highly resistant sealing of the device. Please be aware that aggressive and corrosive gases can influence the sensor element and adversely affect the sealing and the plastic housing.

The use of explosive or toxic gases requires exceptional care and precautions as even the slightest leakage may result in dangerous situations.

For the above reasons, Sensirion only guarantees the safe use of the CMOSens® Mass Flow Meter for inert, in-explosive and non-toxic gases.

The SFM3100 sensor is designed to be robust and shock resistant. Nevertheless, the accuracy of the high-precision SFM3100 may be degraded when handled too rough. Sensirion does not guarantee proper operation in case of improper handling. **Note:** Please avoid applying mechanical stress to the sensor or the mesh.

The sensor is shipped in an antistatic tray to prevent damage by electrostatic discharge. In order to avoid damaging the sensor, ground yourself with a grounding strap or by touching a grounded object before touching the sensor. Furthermore it is advised to store the parts in an antistatic package when not in use.

5.4 ESD

The electronics of the SFM3100 sensor consist of an automotive qualified chip. It complies with the following ESD norms:

- AEC Q 100 002 (4kV HBM)
- AEC Q 100 003 (200V MM)

For ESD tests of the external EEPROM, please consult the datasheet of this component (see chapter 2.3).

Although the sensor complies with these norms, it does not mean the sensor is immune against ESD.

6. Ordering Information

Use the part names and product numbers shown in the table below when ordering SFM3100 sensors. For the latest product information and local distributors, visit www.sensirion.com.

Part name	Product Number 1-10xxxx-xx
SFM3100-240-VC	1-101290-02

Packaging units: 30 items/tray.

Every sensor is traceable by a unique Serial Number.

7. Revision history

Date	Version	Author	Changes
Dec 2016	1.0	SAW	Removal of preliminary, adjusted title, new part name SFM3100-240-VC
Jun 2017	1.01	ALAN	Added Silicone to wetted materials
Jun 2019	1.1	DAT	Correction of O2 formula; removed history of all 0.x versions
April 2020	1.2	DAT	Corrected Appendix A (removed column with resistance values, as this is not relevant for customers)
Nov 2021	1.3	PSIM	added operating overpressure range
Dec 2021	1.4	PSIM	correction in EEPROM addressing

Appendix A: Temperature Curve of additional temperature sensor

°C	Volt	°C	Volt	°C	Volt	°C	Volt	°C	Volt
-40	2.439	5	1.896	50	0.775	95	0.223	140	0.070
-39	2.435	6	1.873	51	0.755	96	0.217	141	0.068
-38	2.431	7	1.850	52	0.735	97	0.211	142	0.066
-37	2.426	8	1.826	53	0.716	98	0.205	143	0.065
-36	2.422	9	1.803	54	0.697	99	0.199	144	0.063
-35	2.417	10	1.778	55	0.678	100	0.194	145	0.062
-34	2.412	11	1.754	56	0.660	101	0.189	146	0.060
-33	2.406	12	1.729	57	0.643	102	0.184	147	0.059
-32	2.400	13	1.704	58	0.625	103	0.179	148	0.058
-31	2.394	14	1.678	59	0.608	104	0.174	149	0.056
-30	2.388	15	1.652	60	0.592	105	0.170	150	0.055
-29	2.381	16	1.626	61	0.576	106	0.165	151	0.054
-28	2.374	17	1.600	62	0.560	107	0.161	152	0.053
-27	2.367	18	1.574	63	0.545	108	0.156	153	0.051
-26	2.359	19	1.547	64	0.530	109	0.152	154	0.050
-25	2.351	20	1.520	65	0.515	110	0.148	155	0.049
-24	2.343	21	1.493	66	0.501	111	0.144	156	0.048
-23	2.334	22	1.467	67	0.487	112	0.141	157	0.047
-22	2.325	23	1.440	68	0.474	113	0.137	158	0.046
-21	2.315	24	1.413	69	0.461	114	0.134	159	0.045
-20	2.305	25	1.386	70	0.448	115	0.130	160	0.044
-19	2.294	26	1.359	71	0.436	116	0.127	161	0.043
-18	2.283	27	1.332	72	0.424	117	0.124	162	0.042
-17	2.272	28	1.305	73	0.412	118	0.120	163	0.041
-16	2.260	29	1.278	74	0.400	119	0.117	164	0.040
-15	2.248	30	1.252	75	0.389	120	0.114	165	0.039
-14	2.235	31	1.225	76	0.378	121	0.111	166	0.039
-13	2.222	32	1.199	77	0.368	122	0.109	167	0.038
-12	2.208	33	1.173	78	0.358	123	0.106	168	0.037
-11	2.193	34	1.147	79	0.348	124	0.103	169	0.036
-10	2.179	35	1.122	80	0.338	125	0.101	170	0.035
-9	2.163	36	1.096	81	0.329	126	0.098	171	0.035
-8	2.147	37	1.071	82	0.320	127	0.096	172	0.034
-7	2.131	38	1.046	83	0.311	128	0.093	173	0.033
-6	2.114	39	1.022	84	0.302	129	0.091	174	0.033
-5	2.097	40	0.998	85	0.294	130	0.089	175	0.032
-4	2.079	41	0.974	86	0.286	131	0.087	176	0.031
-3	2.061	42	0.950	87	0.278	132	0.085	177	0.031
-2	2.042	43	0.927	88	0.270	133	0.083	178	0.030
-1	2.022	44	0.904	89	0.263	134	0.081	179	0.029
0	2.002	45	0.882	90	0.256	135	0.079	180	0.029
1	1.982	46	0.859	91	0.249	136	0.077		
2	1.961	47	0.838	92	0.242	137	0.075		
3	1.940	48	0.816	93	0.235	138	0.073		
4	1.918	49	0.795	94	0.229	139	0.071		

Appendix B: Oxygen flow conversion

The O2 flow can be calculated using the following two formulas.

$$(1) \quad Q[slm] = \left(U[V] - \frac{Offset}{B} \right) \cdot \frac{A}{B} \cdot \text{abs} \left(U[V] - \frac{Offset}{B} \right)$$

$$(2) \quad Q_{O_2}[slm] = Q[slm] \left\{ 1 - \frac{F_{O_2,i}}{\beta} \left(\frac{C_{O_2} - 21\%}{79\%} \right) \right\}$$

$U[V]$ = flow signal from sensor (voltage)

C_{O_2} = O₂ concentration (e.g. 100%, if pure O₂ is used)

$Q[slm]$ = calculation of flow without O₂ correction
refer to chapter 3.1: flow calculation

$Q_{O_2}[slm]$ = flow at a specified O₂ concentration

All other constants for formula (1) and (2) and the matrix for the O₂ correction values ($Q_{O_2} \times F_{O_2}$) can be found on the EEPROM. The values are stored as 16bit signed Int.

Step by step instruction:

1. Calculate air flow $Q[slm]$ with formula (1)
 - a. If sensor is used to measure an air flow, use the value as is
 - b. if sensor is used to measure O₂ or an O₂-Air mixture go to step 2
2. Use the value calculated under step 1 in formula (2).
 - a. Select the value for $F_{O_2,i}$: take $Q[slm]$ multiply it by 100 and search for the closest value in table $Q_{O_2,i}$ then choose the corresponding $F_{O_2,i}$
 - b. Use these values to calculate the O₂ flow $Q_{O_2}[slm]$ with formula (2).

Byte address within EEPROM

Value	Byte address within EEPROM (A9-A0)	Description
A	0x1AA	Required for formula (1)
	0x1AB	
B	0x1A8	Required for formula (1)
	0x1A9	
Offset	0x1AC	Required for formula (1)
	0x1AD	
α	0x100	Required for formula (2)
	0x101	
β	0x102	Required for formula (2)
	0x103	

Q _{O₂} x F _{O₂}		
size of matrix	0x106	Size of the Q _{O₂} x F _{O₂} matrix
	0x107	
	0x108	

$Q_{O2,1}$	0x109	Lowest flow value (value as 16bit signed Int) required for formula (2)
$F_{O2,1}$	0x10A	Correction factor corresponding to $Q_{O2,1}$, e.g. 0.02 (value as 16bit Int) required for formula (2)
	0x10B	
...	0x1..	Required for formula (2)
	0x1..	
...	0x1..	Required for formula (2)
	0x1..	
$Q_{O2,40}$	0x1A4	Required for formula (2)
	0x1A5	
$F_{O2,40}$	0x1A6	Required for formula (2)
	0x1A7	

Important Notices

Warning, personal injury

Do not use this product as safety or emergency stop devices or in any other application where failure of the product could result in personal injury (including death). Do not use this product for applications other than its intended and authorized use. Before installing, handling, using or servicing this product, please consult the datasheet and application notes. Failure to comply with these instructions could result in death or serious injury.

If the Buyer shall purchase or use SENSIRION products for any unintended or unauthorized application, Buyer shall defend, indemnify and hold harmless SENSIRION and its officers, employees, subsidiaries, affiliates and distributors against all claims, costs, damages and expenses, and reasonable attorney fees arising out of, directly or indirectly, any claim of personal injury or death associated with such unintended or unauthorized use, even if SENSIRION shall be allegedly negligent with respect to the design or the manufacture of the product.

ESD Precautions

The inherent design of this component causes it to be sensitive to electrostatic discharge (ESD). To prevent ESD-induced damage and/or degradation, take customary and statutory ESD precautions when handling this product.

See application note "Handling Instructions" for more information.

Warranty

SENSIRION warrants solely to the original purchaser of this product for a period of 12 months (one year) from the date of delivery that this product shall be of the quality, material and workmanship defined in SENSIRION's published specifications of the product. Within such period, if proven to be defective, SENSIRION shall repair and/or replace this product, in SENSIRION's discretion, free of charge to the Buyer, provided that:

- notice in writing describing the defects shall be given to SENSIRION within fourteen (14) days after their appearance;

- such defects shall be found, to SENSIRION's reasonable satisfaction, to have arisen from SENSIRION's faulty design, material, or workmanship;
- the defective product shall be returned to SENSIRION's factory at the Buyer's expense; and
- the warranty period for any repaired or replaced product shall be limited to the unexpired portion of the original period.

This warranty does not apply to any equipment which has not been installed and used within the specifications recommended by SENSIRION for the intended and proper use of the equipment. EXCEPT FOR THE WARRANTIES EXPRESSLY SET FORTH HEREIN, SENSIRION MAKES NO WARRANTIES, EITHER EXPRESS OR IMPLIED, WITH RESPECT TO THE PRODUCT. ANY AND ALL WARRANTIES, INCLUDING WITHOUT LIMITATION, WARRANTIES OF MERCHANTABILITY OR FITNESS FOR A PARTICULAR PURPOSE, ARE EXPRESSLY EXCLUDED AND DECLINED.

SENSIRION is only liable for defects of this product arising under the conditions of operation provided for in the datasheet and proper use of the goods. SENSIRION explicitly disclaims all warranties, express or implied, for any period during which the goods are operated or stored not in accordance with the technical specifications.

SENSIRION does not assume any liability arising out of any application or use of any product or circuit and specifically disclaims any and all liability, including without limitation consequential or incidental damages. All operating parameters, including without limitation recommended parameters, must be validated for each customer's applications by customer's technical experts. Recommended parameters can and do vary in different applications.

SENSIRION reserves the right, without further notice, (i) to change the product specifications and/or the information in this document and (ii) to improve reliability, functions and design of this product.

Copyright © 2001-2015, SENSIRION.
CMOSens® is a trademark of Sensirion
All rights reserved

Headquarters and Subsidiaries

SENSIRION AG
Laubisruetistr. 50
CH-8712 Staefa ZH
Switzerland

phone: +41 44 306 40 00
fax: +41 44 306 40 30
info@sensirion.com
www.sensirion.com

Sensirion AG (Germany)
phone: +41 44 927 11 66
info@sensirion.com
www.sensirion.com

Sensirion Inc., USA
phone: +1 805 409 4900
info_us@sensirion.com
www.sensirion.com

Sensirion Japan Co. Ltd.
phone: +81 3 3444 4940
info@sensirion.co.jp
www.sensirion.co.jp

Sensirion Korea Co. Ltd.
phone: +82 31 337 7700~3
info-kr@sensirion.com
www.sensirion.co.kr

Sensirion China Co. Ltd.
phone: +86 755 8252 1501
info@sensirion.com.cn
www.sensirion.com.cn

To find your local representative, please visit www.sensirion.com/contact