

PCB LAYOUT

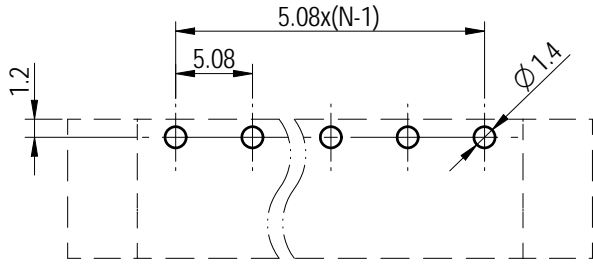

未注公差/General tolerances (mm)												0.1/10		
0 ~ 3	>3 ~ 6	>6 ~ 10	>10 ~ 18	>18 ~ 30	>30 ~ 50	>50 ~ 80	>80 ~ 120	>120 ~ 180	>180 ~ 250	>250 ~ 315	>315 ~ 400		>400 ~ 500	>500
±0.12	±0.18	±0.22	±0.26	±0.31	±0.37	±0.57	±0.80	±0.93	±1.05	±1.15	±1.60	±2.20	±2.50	±2'

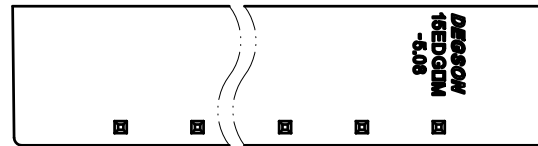
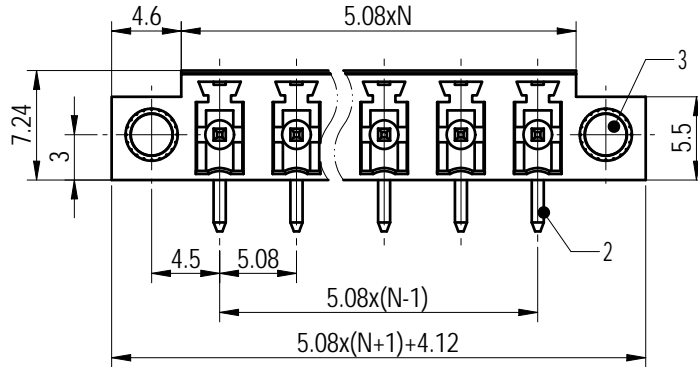
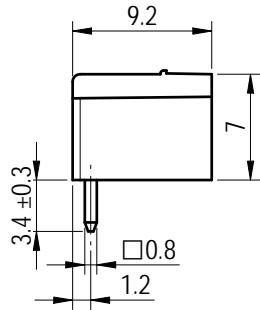
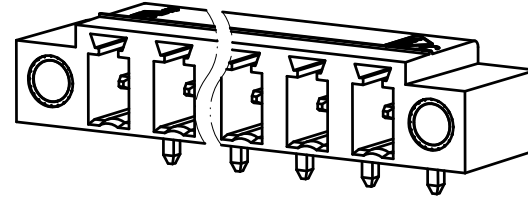
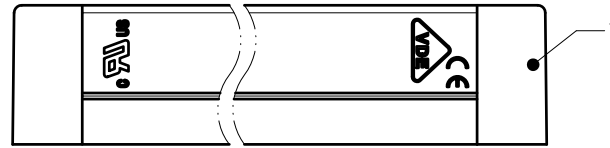

3	Nut	Copper alloy	/
2	Pin	Copper alloy	Sn Plated
1	Housing	PA66	UL94V-0
ITEM	NAME OF PART	MATERIAL	NOTES

UL 标准/UL Standard:	B	C	D
额定电压/电流/Rated Voltage(V)/Current(A)	300/8	/	/
IEC 标准/IEC Standard:			
过压类别/Overvoltage Category/污染等级/Pollution Degree	III/3	III/2	II/2
额定电压/电流/Rated Voltage(V)/Current(A)	/	/	450/7
额定脉冲电压(KV)/Rate Impulse Voltage(KV)	/	/	4
间距/Pitch(mm)/线数范围/Poles	5.08/N=02~12P		
使用温度范围/Operating temperature(°C)	-40~+105		
符合RoHS环保要求/Conform to RoHS	Yes		
标准颜色编号/Standard color number: PANTONE / RAL	/		



APPD: 兰春华	2022.08.31
CHKD: 龚耀志	2022.08.30
DRFT: 胡松	2022.08.30

MATERIAL:	SURFACE/COLOR:		
MAT NO./REV:	/ 00	MAT STATUS: 批量	
NAME			
15EDGRM-5.08-XXP-1Y-00L(H)			
DRAWING NO.	TYPE	DRAWING STATUS	SCALE
200029809	CUSTOMER DRAWING	已发布	2:1
			SHEET
			1/1

REV	ECN	DESCRIPTION	DRFT	DATE
00			胡松	2022.08.30

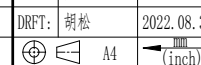

Transfer or duplication of this document as well as the utilization or communication of its contents are prohibited unless authorized in writing by Degson. All rights reserved for patent. 除专利等明确标注外，其他内容均归德松公司所有。未经许可，不得复制或传播。 德松公司保留所有权利。