

Transfer or duplication of this document as well as the utilization or communication of its contents are prohibited unless authorized in writing by DEGSON. All rights reserved for patent, utility model or design registrations. 除专利权明确标注外, 否则禁止转让、复制、引用、交流等文件的行为, 一经发现将依法追究。本公司保留对涉及发明、实用新型及外观设计的所有权利。

未注公差/General tolerances (mm)													D 0.1/10	
0	>3	>6	>10	>18	>30	>50	>80	>120	>180	>250	>315	>400		>500
±0.12	±0.18	±0.22	±0.26	±0.31	±0.37	±0.57	±0.80	±0.93	±1.05	±1.15	±1.60	±2.20	±2.50	±2'

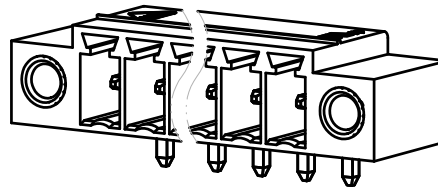
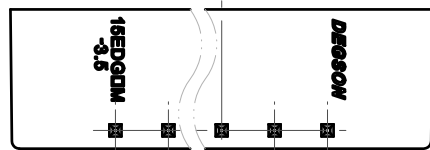
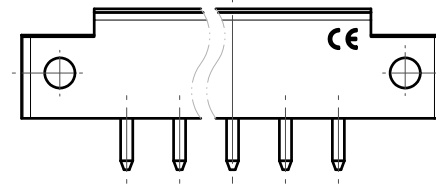
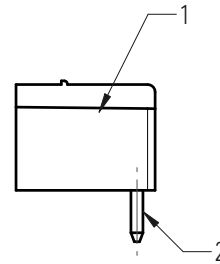
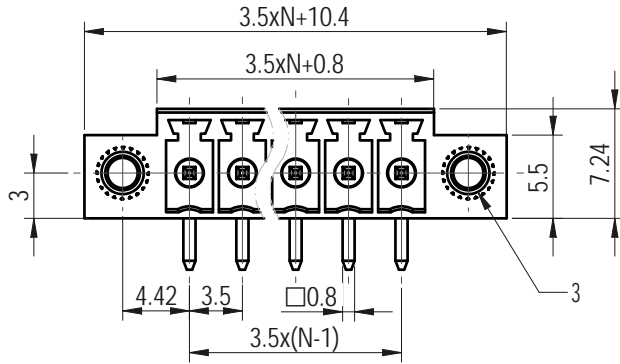
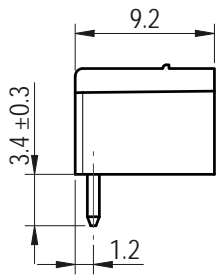
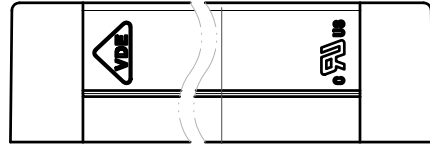
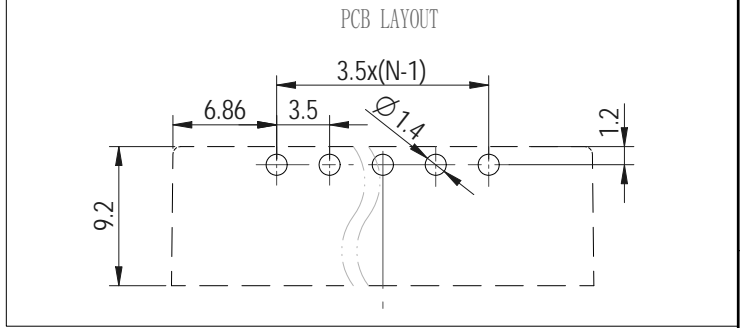

3	Nut	Copper alloy	/
2	Pin	Copper alloy	Sn Plated
1	Housing	PA66	UL94V-0
ITEM	NAME OF PART	MATERIAL	NOTES

UL 标准/UL Standard:	B	C	D
额定电压/电流/Rated Voltage(V)/Current(A)	300/8	/	300/8
IEC 标准/IEC Standard:			
过压类别/Overvoltage Category/污染等级/Pollution Degree	III/3	III/2	II/2
额定电压/电流/Rated Voltage(V)/Current(A)	/	/	250/7
额定脉冲电压(KV)/Rate Impulse Voltage(KV)	/	/	2.5
间距/Pitch(mm)/线数范围/Poles	3.5/N=02~22P		
使用温度范围/Operating temperature(°C)	-40~+105		
符合RoHS环保要求/Conform to RoHS	Yes		

APPD: 兰春华	2022.09.06
CHKD: 龚耀志	2022.09.05
DRFT: 周锡锦	2022.09.05

MATERIAL:	SURFACE/COLOR:
MAT NO./REV: / 00	MAT STATUS:

NAME		15EDGRM-3.5-XXP-1Y-00L(H)		
------	--	---------------------------	--	--

00	REV	ECN	DESCRIPTION	周锡锦	2022.09.05	DRFT	周锡锦	2022.09.05	DRAWING NO.	200029722	TYPE	CUSTOMER DRAWING	DRAWING STATUS	已发布	SCALE	2:1	SHEET	1/1
----	-----	-----	-------------	-----	------------	------	-----	------------	-------------	-----------	------	------------------	----------------	-----	-------	-----	-------	-----