

PCB LAYOUT

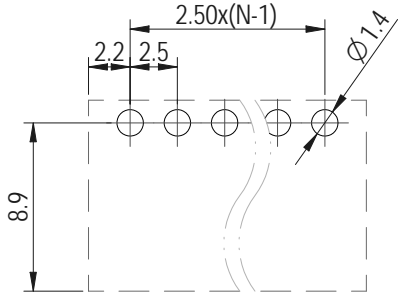

未注公差/General tolerances (mm)													0.1/10 ±2'
0 ~ 3	>3 ~ 6	>6 ~ 10	>10 ~ 18	>18 ~ 30	>30 ~ 50	>50 ~ 80	>80 ~ 120	>120 ~ 180	>180 ~ 250	>250 ~ 315	>315 ~ 400	>400 ~ 500	
±0.12	±0.18	±0.22	±0.26	±0.31	±0.37	±0.57	±0.80	±0.93	±1.05	±1.15	±1.60	±2.20	±2.50

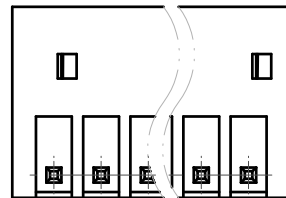
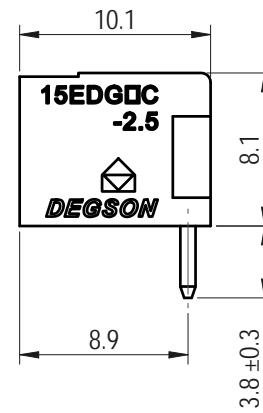
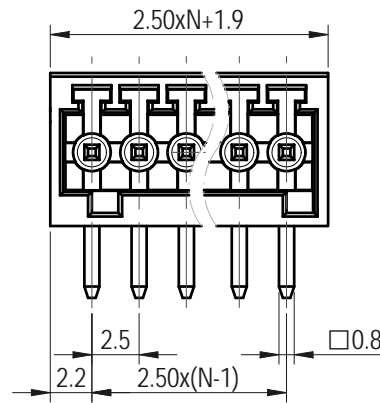
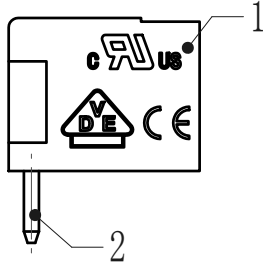
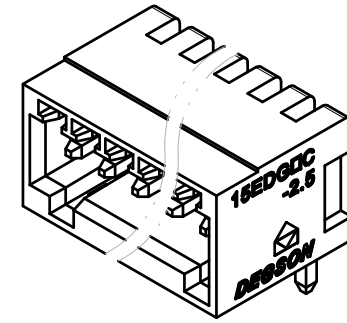

2	Pin	Copper alloy	Sn Plated
1	Housing	PA66	UL94V-0
ITEM	NAME OF PART	MATERIAL	NOTES

UL 标准/UL Standard:	B	C	D
额定电压/电流/Rated Voltage(V)/Current(A)	150/4	/	/
IEC 标准/IEC Standard:			
过压类别/Overvoltage Category/污染等级/Pollution Degree	III/3	III/2	II/2
额定电压/电流/Rated Voltage(V)/Current(A)	/	/	250/5
额定脉冲电压(KV)/Rate Impulse Voltage(KV)	/	/	2.5
间距/Pitch(mm)/线数范围/Poles	2.5/N=02~12P		
使用温度范围/Operating temperature(°C)	-40~+105		
符合RoHS环保要求/Conform to RoHS	Yes		

APPD: 兰春华	2022.09.09
CHKD: 龚耀志	2022.09.08
DRFT: 朱岳鹏	2022.09.08

MATERIAL:	SURFACE/COLOR:		
MAT NO./REV:	/ 00	MAT STATUS:	
NAME			
15EDGRC-2.5-XXP-1Y-00L(H)			

00			朱岳鹏	2022.09.08
REV	ECN	DESCRIPTION	DRFT	DATE

DRAWING NO.	TYPE	DRAWING STATUS	SCALE	SHEET
200103973	CUSTOMER DRAWING	已发布	2.5:1	1/1

02P

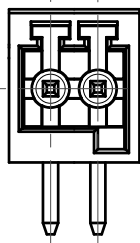

Transfer or duplication of this document as well as the utilization or communication of its contents are prohibited unless authorized in advance. Violations will be held for compensation. All rights reserved for patent, utility model or design registrations. 除特别注明授权外, 否则禁止译法、复制、引用、光碟等文件的传播、使用、复印、光碟等文件的传播、使用、复印。未经授权擅自复制或传播, 公司将依法追究法律责任。 除特别注明授权外, 否则禁止译法、复制、引用、光碟等文件的传播、使用、复印。未经授权擅自复制或传播, 公司将依法追究法律责任。