

1 2 3 4 5

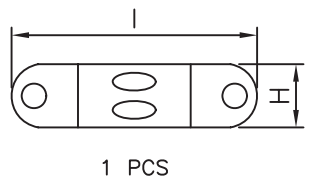

TECHNICAL CHARACTERISTICS
 MATERIAL
 INSULATOR: ABS RESIN METALIZED
 COLOR: CHROMATE CLAIR
 ENVIRONMENTAL
 FLAMMABILITY RATING: UL94-HB
 COMPLIANCE: LEAD FREE AND ROHS
 PACKAGING: BAG

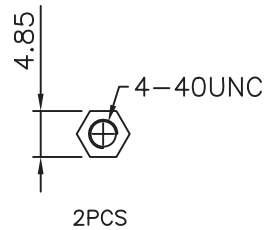
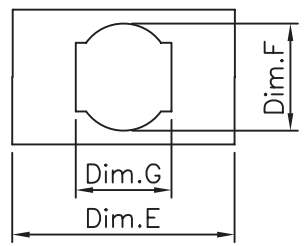
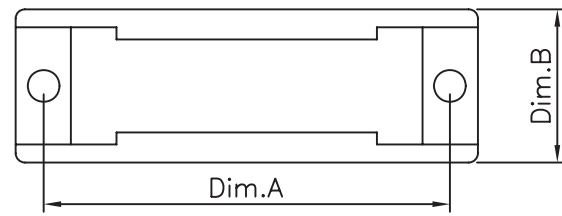
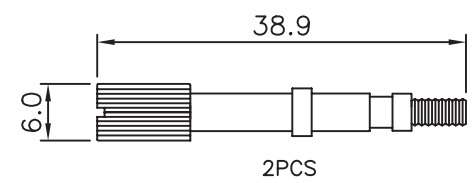
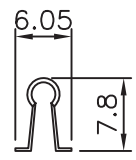
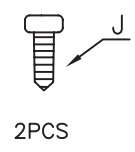
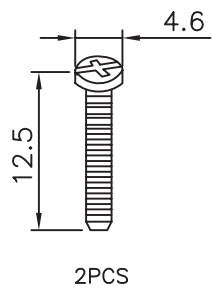
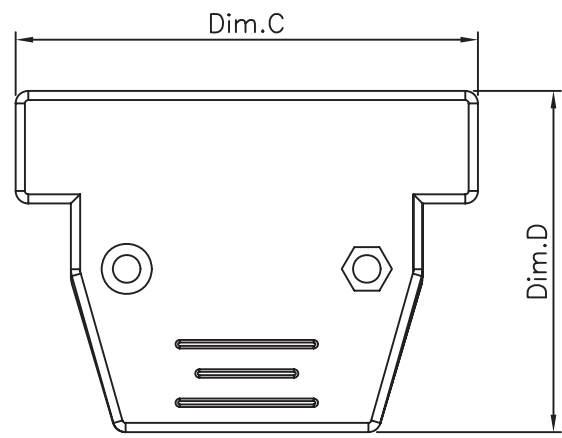

Circuits	Dim.A	Dim.B	Dim.C	Dim.D	Dim.E	Dim.F	Dim.G	Dim.H	Dim.I	Dim.J
09	25.0	18.0	31.3	29.8	14.3	9.2	11.9	5.7	16.5	STG-2.6*6
15	33.5	18.0	43.2	37.1	18.0	10.4	12.8	5.8	19.3	STG-2.6*6
25	47.0	18.2	55.3	41.0	25.0	11.2	14.0	6.5	26.5	STG-2.3*6

RoHS Compliant			
G			
F			
E	10-NOV-14	VIEWS+PACKG.	AS
D	20-MAR-13	FLAMABILITY	AR
C	23-OCT-12	COMPATIBILITY	GG
B	26-NOV-08	COMPATIBILITY	JP
A	29-DEC-06	PDF	JP
REV	DATE	FILE	BY

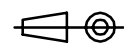
PROJECTION:

 APPROVAL: NPr

GENERAL TOLERANCE
 .X = +/- 0.2
 .XX = +/- 0.15
 UNIT: MM
 SCALE:
 SHEET: 1/4
 DRAW: AS



DESCRIPTION: WR-DSUB METALIZED PLASTIC HOOD TOP ENTRY
 4-40 SCREW
 WERI PART NO: 6180 xx 253 11

SIZE
A4

A
 B
 C
 D

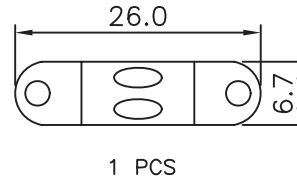
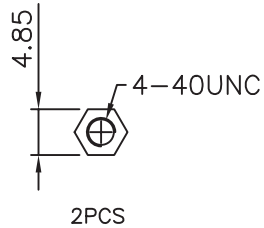
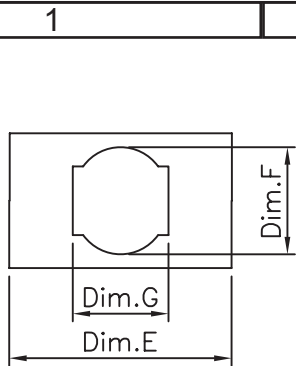

TECHNICAL CHARACTERISTICS

MATERIAL
INSULATOR: ABS RESIN METALIZED
COLOR: CHROMATE CLAIR

ENVIRONMENTAL
FLAMMABILITY RATING: UL94-HB
COMPLIANCE: LEAD FREE AND ROHS

PACKAGING: BAG



NOT COMPATIBLE WITH THE CRIMPING HOUSING:
618 0xx 217 122 & 618 0xx 217 222

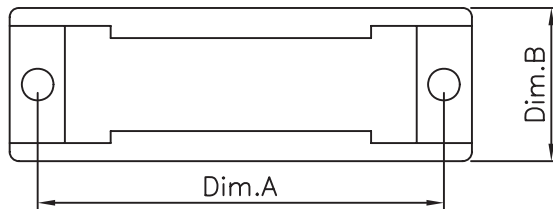
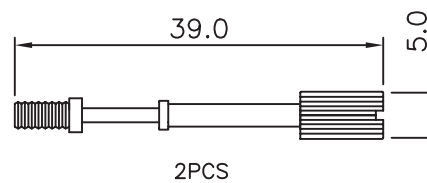
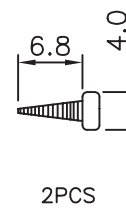
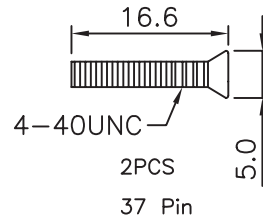
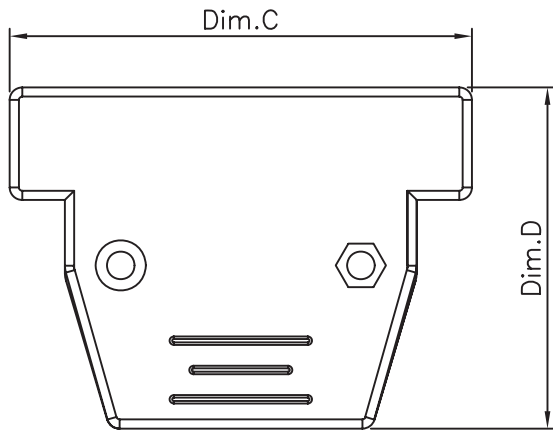

Circuits	Dim.A	Dim.B	Dim.C	Dim.D	Dim.E	Dim.F	Dim.G
37	63.5	18.2	70.5	48.0	33.0	14.0	15.8

RoHS Compliant			
G			
F			
E			
D	10-NOV-14	IEWS+PACKG.	AS
C	20-MAR-13	FLAMABILITY	AR
B	26-NOV-08	COMPATIBILITY	JP
A	29-DEC-06	PDF	JP
REV	DATE	FILE	BY

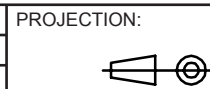

PROJECTION:

APPROVAL: NPr

GENERAL TOLERANCE

.X = +/- 0.2

.XX = +/- 0.15



UNIT: MM

SCALE:

SHEET: 2/4

DRAW: AS

DESCRIPTION: WR-DSUB METALIZED PLASTIC HOOD TOP ENTRY
4-40 SCREW

WERI PART NO: 6180 xx 253 11

SIZE

A4

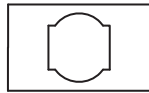
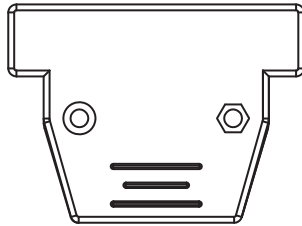

Note:
1.Dimension:
Carton Size:40*28*28(cm)

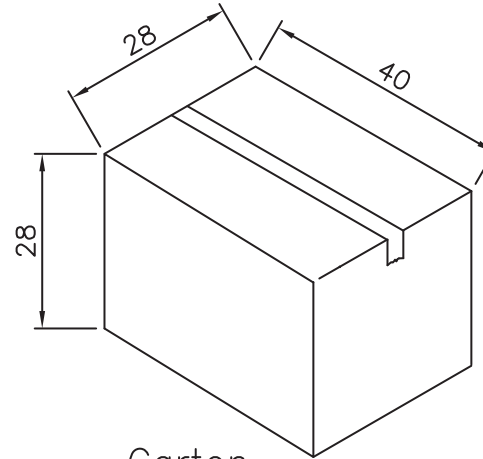
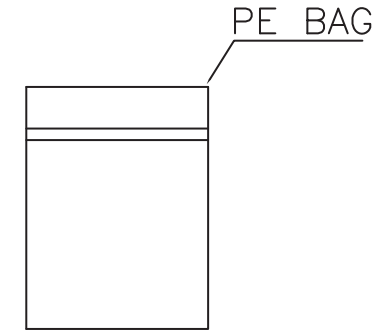

Carton

Pin.	Pcs/Bag	Pcs/Carton
9	100	600
15	100	400
25	50	300
37	50	300

RoHS Compliant

G			
F			
E			
D			
C			
B			
A	10-NOV-14	PDF	AS
REV	DATE	FILE	BY

PROJECTION:

GENERAL TOLERANCE
.X = +/- 0.2
.XX = +/- 0.15



APPROVAL: NPr

UNIT: MM
SCALE:
SHEET: 3/4
DRAW: AS

DESCRIPTION: WR-DSUB METALIZED PLASTIC HOOD TOP ENTRY
4-40 SCREW
WERI PART NO: 618 0xx 253 11

SIZE
A4

1

2

3

4

5

Cautions and Warnings:

This electronic component is designed and developed with the intention for use in general electronics equipments.

Before incorporating the components into any equipments in the field such as aerospace, aviation, nuclear control, submarine, transportation, (automotive control, train control, ship control), transportation signal, disaster prevention, medical, public information network etc. where higher safety and reliability are especially required or if there is possibility of direct damage or injury to human body, Würth Elektronik must be asked for a written approval.



In addition, even electronic component in general electronic equipments, when used in electrical circuits that require high safety, reliability functions or performance, the sufficient reliability evaluation-check for the safety must be performed before by the user before usage.

A

B

C

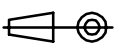
RoHS Compliant

G				PROJECTION: 	GENERAL TOLERANCE .X = +/- 0.2 .XX = +/- 0.15		
F							
E							
D							
C				APPROVAL: JC	UNIT: MM	DESCRIPTION: DISCLAIMER	SIZE A4
B					SCALE:		
A	10-SEP-14	PDF	QL		SHEET: 4/4	WERI PART NO: DISCLAIMER	
REV	DATE	FILE	BY		DRAW: QL		

D