

Guard Lock Safety Key Selector Switch A22LK

CSM_A22LK_DS_E_6_3

The guard lock prevents accidental mode changes.

- Selector Switch for secure equipment activation during maintenance
- The guard lock of the Operation Unit prevents incorrect operation.
- The key has the same shape as the following keys.
 - The key of the A22TK Safety Key Selector Switch
 - The trapped key of the D4JL Guard Lock Safety-door Switch
 - The lockout key of the D4SL-NSK10-LK Slide Key Unit



Be sure to read the "Safety Precautions" on page 8.

For the most recent information on models that have been certified for safety standards, refer to your OMRON website.

Features

Because the A22LK Guard Lock Safety Key Selector Switch uses the same key as the Guard Lock Safety-door Switch, the operator is prevented from forgetting to remove the key. The result is a safer working environment when performing maintenance.

Common Key for Door Switch and Selector Switch



Broad range of applications include use with door locks, mode switching, and emergency stops when teaching

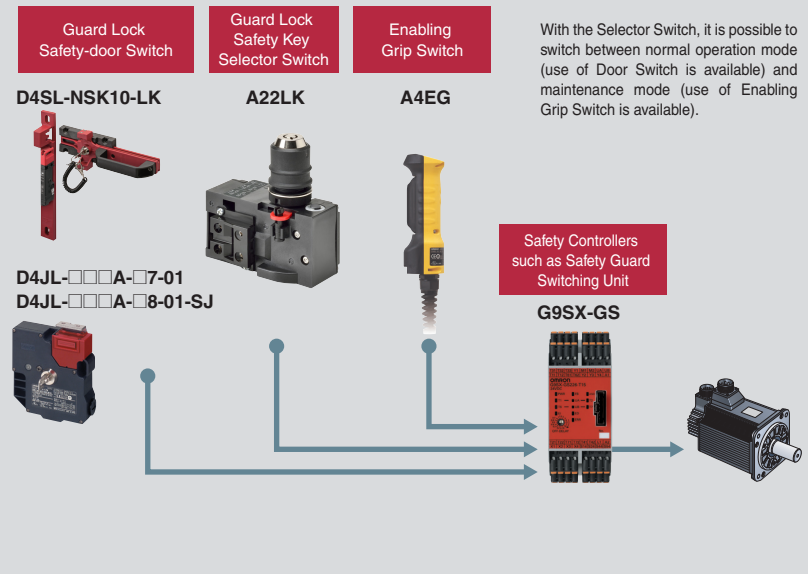

Application Examples

Locking the A22LK-2RLB-□ in the RUN Position

The facilities will generally be stopped if the mode is changed to MAINTENANCE mode during operation. Locking the A22LK-2RLB-□ in the RUN position prevents the facilities from being stopped unintentionally.

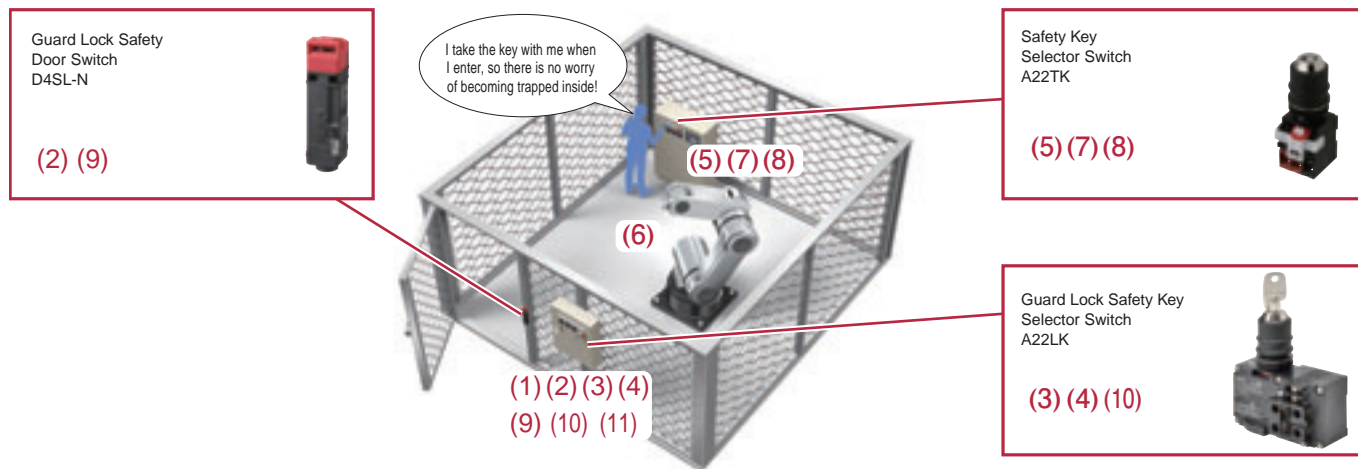





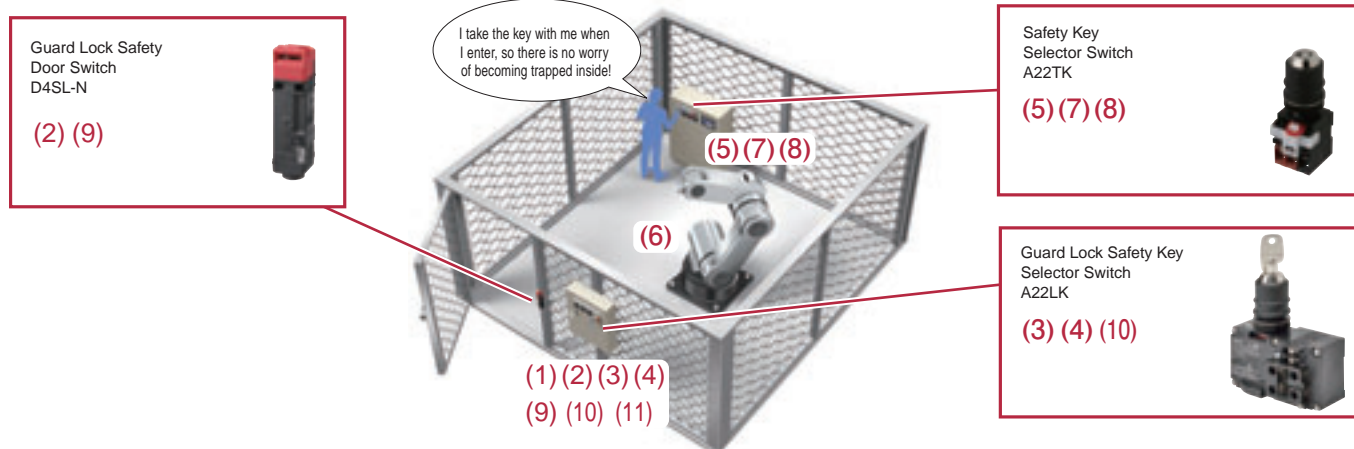

| Operation | Machine status | Machine operating mode | | |
|---------------------------------|------------------|------------------------|---|--|
| | | Routine | Non-routine Maintenance : Disable / Maintenance : Enable | |
| (1) Facilities stopped | RUN→STOP | | | 1. Press the stop button on the machine. 2. Confirm that the machine has stopped. 3. Enable the D4SL-N and A22LK to be unlocked. |
| (2) Door unlocked | STOP | | | Unlock the D4SL-N |
| (3) Mode changed | STOP | → | | 1. Unlock the A22LK. 2. Turn the key to switch from [RUN] mode to [MAINTENANCE] mode. |
| (4) Open door and enter | STOP | | | 1. Remove the key of the A22LK. 2. Open the door, and enter with the key. |
| (5) Mode changed to MAINTENANCE | STOP | | → | Insert the key into the A22TK, and turn the key to switch from [RUN] mode to [MAINTENANCE] mode. |
| (6) Start maintenance | MAINTENANCE | | | Start maintenance. |
| (7) End maintenance | MAINTENANCE→STOP | | ← | Turn the key of the A22TK to switch from [MAINTENANCE] mode to [RUN] mode after maintenance. |
| (8) Exit | STOP | | | 1. Remove the key of the A22TK. 2. Exit with the key. |
| (9) Door locked | STOP | | | Close the door, and lock the D4SL-N. |
| (10) Mode changed | STOP | ← | | 1. Insert the key into the A22LK, and turn the key of the A22LK to switch from [MAINTENANCE] mode to [RUN] mode. 2. Lock the A22LK. |
| (11) Operation restarted | STOP→RUN | | | Press the start button on the machine to restart operation. |

Locking the A22LK-2RLA-□ in the MAINTENANCE Position

Maintenance is performed without stopping the facilities after the door switch is temporarily disabled. If the mode is changed to RUN mode while the door is open, the door switch will be enabled and the facilities will be stopped. Locking the A22LK-2RLA-□ in the MAINTENANCE position prevents the mode from being changed unintentionally.



| Operation | Machine status | Machine operating mode | | | |
|---------------------------------|-------------------|------------------------|-----------------------|----------------------|---|
| | | Routine | Non-routine | | |
| | | | Maintenance : Disable | Maintenance : Enable | |
| (1) Facilities stopped | RUN→STOP | | | | 1. Press the stop button on the machine. 2. Confirm that the machine has stopped. 3. Enable the D4SL-N to be unlocked. |
| (2) Door unlocked | STOP | | | | Unlock the D4SL-N |
| (3) Mode changed | STOP | → | | | 1. Turn the key of the A22LK to switch from [RUN] mode to [MAINTENANCE] mode. 2. Lock the A22LK.  |
| (4) Open door and enter | STOP | | | | 1. Remove the key of the A22LK. 2. Open the door, and enter with the key.  |
| (5) Mode changed to MAINTENANCE | STOP | | → | | Insert the key into the A22TK, and turn the key to switch from [RUN] mode to [MAINTENANCE] mode.  |
| (6) Start maintenance | MAINTENANCE | | | | Start maintenance. |
| (7) End maintenance | MAINTENANCE →STOP | | ← | | Turn the key of the A22TK to switch from [MAINTENANCE] mode to [RUN] mode after maintenance.  |
| (8) Exit | STOP | | | | 1. Remove the key of the A22TK. 2. Exit with the key.  |
| (9) Door locked | STOP | | | | Close the door, and lock the D4SL-N. |
| (10) Mode change unlocked | STOP | | | | 1. Confirm that the door is closed and locked (lock monitor of the D4SL-N), and then enable the A22LK to be unlocked. 2. Unlock the A22LK. |
| (11) Mode changed | STOP | ← | | | Insert the key into the A22LK, and turn the key of the A22LK to switch from [MAINTENANCE] mode to [RUN] mode.  |
| (12) Operation restarted | STOP→RUN | | | | Press the start button on the machine to restart operation. |

Model Number Structure

Model Number Legend (Ordering as a set)

The Operation Unit and Switch Unit are delivered as a set. For information on combinations, refer to Ordering Information on page 5.

A 2 2 L K - - 22 - K 01 - S J

(1) Operation Unit

| Symbol | No. of notches | Key release position | Key position of NC contact closing | Lock position * |
|--------|----------------|----------------------|------------------------------------|-----------------|
| 2RLA | 2 | | | |
| 2RLB | | | | |

* Lock and release type are Solenoid lock and Mechanical release.

(3) Key Availability

| Symbol | Type |
|--------|----------|
| None | No key |
| K | With key |

(4) Key Type

| Symbol | Type |
|--------|--------|
| 01 | 1 type |

(2) Contact Configuration

| Symbol | Type |
|--------|-----------------|
| 22 | 1NC/1NO+1NC/1NO |

Contact Configuration

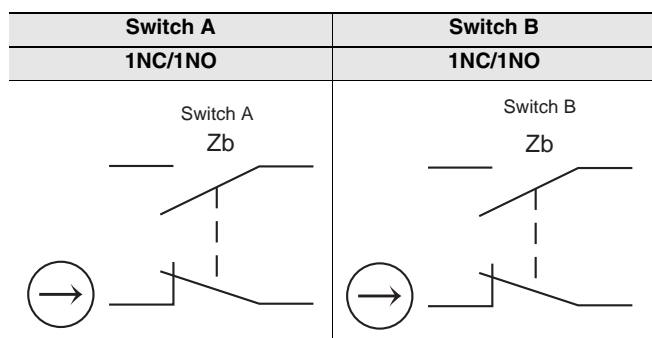

Switch Arrangement

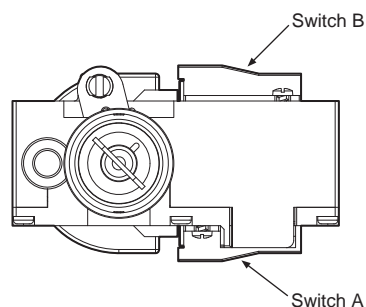

Key drop preventive (on the A22LK-2RLA-□)

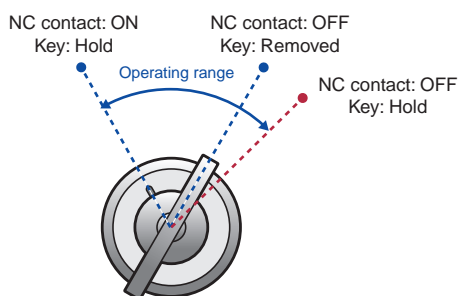

Operation Angle

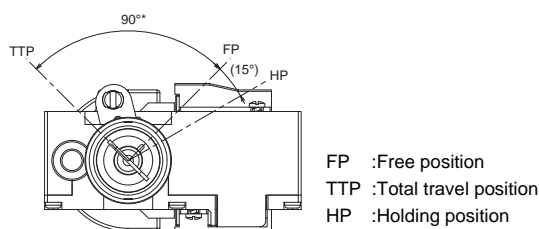











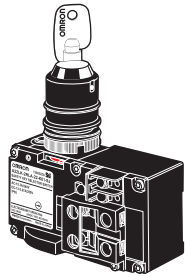

FP :Free position
TTP :Total travel position
HP :Holding position

* Always be careful to turn the key completely to the FP (HP) or TTP position to ensure that the contacts are properly switched and the direct open circuit operation characteristics are obtained.

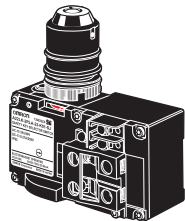
Ordering Information

Switch

List of Models (Completely Assembled) ... Shipped as a set which includes the Operation Unit and Switch Unit. For the model with Operation Unit only, contact your OMRON representative.

| Appearance | Key release position | Key position of NC contact closing | Lock position * | Contact Configuration | Key availability | Model |
|---|---|---|---|-----------------------|------------------|-----------------------------|
|  |  |  |  | 1NC/1NO+1NC/1NO | Yes | A22LK-2RLA-22-K01-SJ |
| |  |  |  | 1NC/1NO+1NC/1NO | Yes | A22LK-2RLB-22-K01-SJ |
|  |  |  |  | 1NC/1NO+1NC/1NO | No | A22LK-2RLA-22-01-SJ |
| |  |  |  | 1NC/1NO+1NC/1NO | No | A22LK-2RLB-22-01-SJ |

* Lock and release type are Solenoid lock and Mechanical release.

Specifications

Certified Standards

| Certification body | Standards | File No. |
|--------------------|--|--|
| UL | UL508, CSA C22.2 No.14 | E76675 |
| TÜV SÜD | EN60947-5-1 (certified direct opening) | Consult your OMRON representative for details. |
| CQC(CCC) | GB/T 14048.5 | Consult your OMRON representative for details. |
| KOSHA | KS C IEC 60947-5-1 | Consult your OMRON representative for details. |

Note: Only models with NC contacts have a direct opening mechanism.

Certified Standard Ratings

TÜV (EN60947-5-1)

| Item | Utilization category | AC-15 | DC-13 |
|------------------------------|----------------------|-------|-------|
| Rated operating current (Ie) | | 3A | 0.27A |
| Rated operating voltage (Ue) | | 240V | 250V |

Note: Use a 10 A fuse type gI or gG that conforms to IEC60269 as a short-circuit protection device. This fuse is not built into the Switch.

Solenoid Coil Characteristics

| Item | Type | 24 VDC |
|-----------------------------------|------|----------------------|
| Rated operating voltage (100% ED) | | 24 VDC ±10% |
| Current consumption | | Approx. 88mA |
| Insulation | | Class A (130°C max.) |

Characteristics

| Item | Model | A22LK |
|----------------------------------|------------------------------------|---|
| Allowable operating frequency | Mechanical | 30 operations/minute max. |
| | Electrical | 30 operations/minute max. |
| Insulation resistance | | 100 MΩ min. (at 500 VDC) |
| Dielectric strength | Between terminals of same polarity | 2,500 VAC, 50/60Hz for 1min. |
| | Between each terminal and ground | 6,000 VAC, 50/60Hz for 1min. |
| Vibration resistance *1 | | 10 to 55 Hz, 1.5mm double amplitude (within 1 ms) |
| Shock resistance | Destruction | 1000m/s ² |
| | Malfunction *1 | 300m/s ² |
| Durability | Mechanical | 100,000 operations min. |
| | Electrical | 100,000 operations min. |
| Ambient operating temperature *2 | | -10 to +55°C |
| Ambient operating humidity | | 35% to 85%RH |
| Degree of protection *3 | | IP65 *3 |
| Electric shock protection class | | Class II |
| Degree of contamination | | 3 (EN60947-5-1) |

- Note:**
- Do not allow the load current to exceed the rated value.
 - The contact ON/OFF timing is not synchronized. Confirm performance before application.
 - Once the contacts have been used to switch a load, however, they cannot be used to switch smaller loads. The contact surfaces will become rough once they have been used and contact reliability for smaller loads may be reduced.

*1. Malfunction within 1 ms.

*2. With no icing or condensation.

*3. The degree of protection from the front of the panel.

Structure and Nomenclature

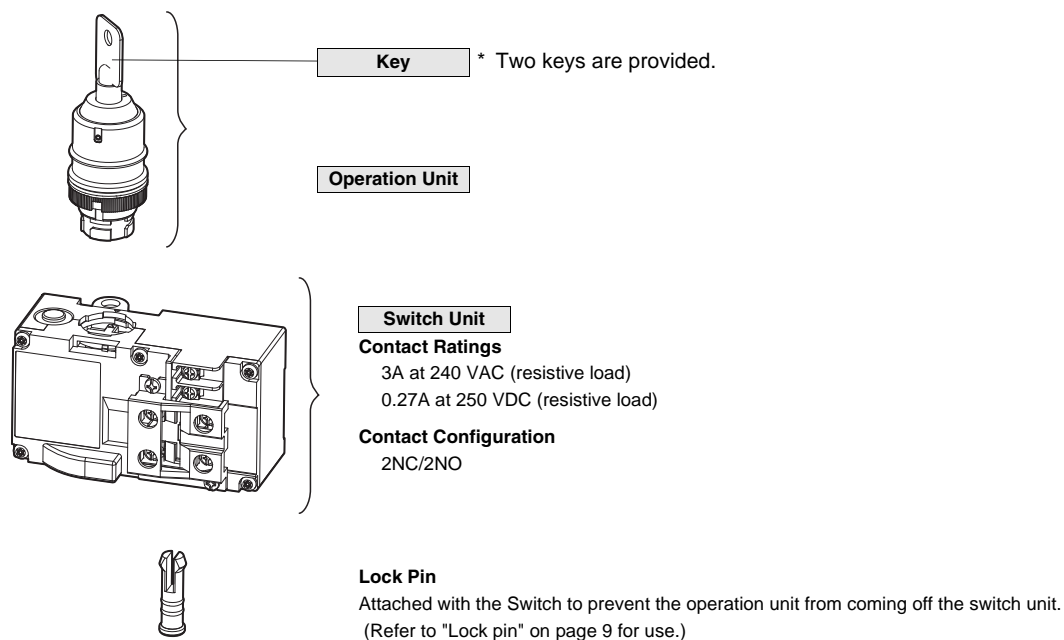

(The above figures are examples of the model with key.)

Connection

Internal Circuit Diagram

- Direct opening contacts used as safety-circuit input are indicated with the \ominus mark.
- The solenoid has no polarity.

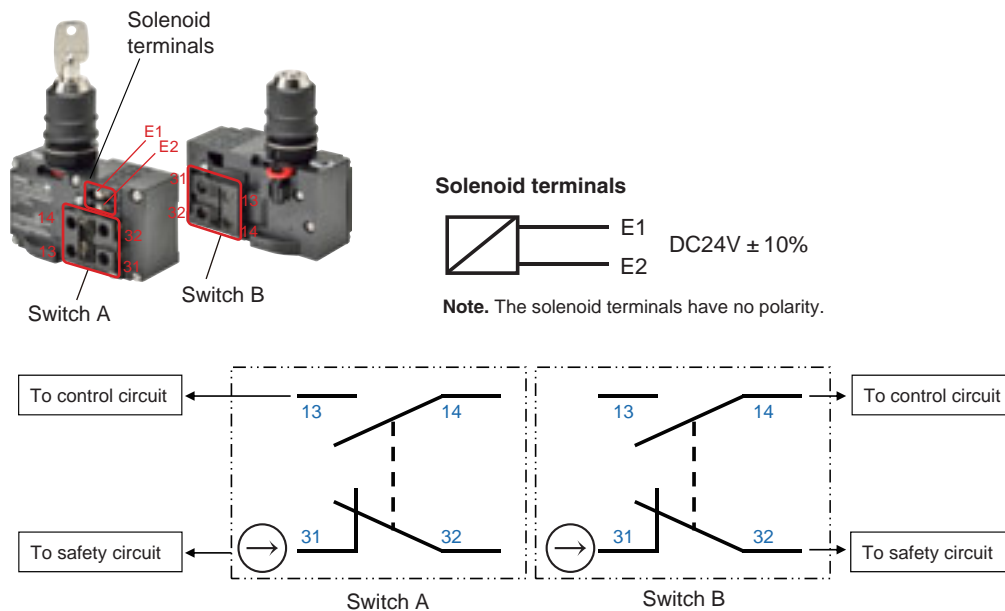

Dimensions

A22LK-2RL□-22-K01-SJ

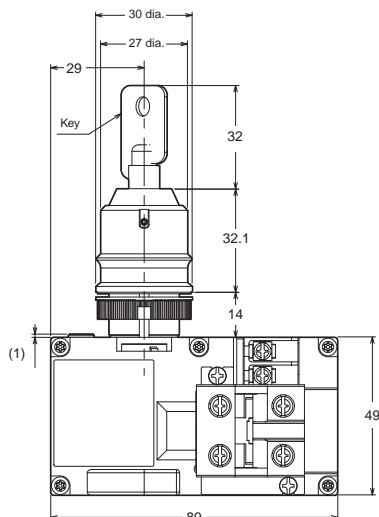
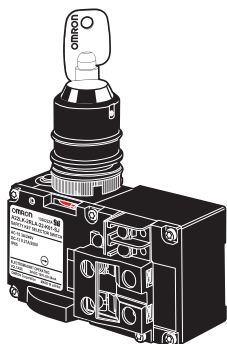

Note: Unless otherwise specified, a tolerance of ± 0.8 mm applies to all dimensions.

Installation

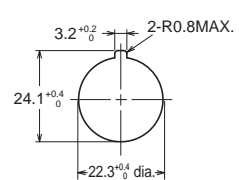
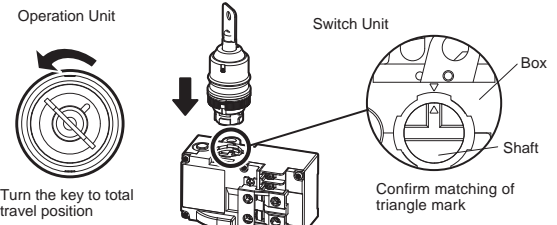
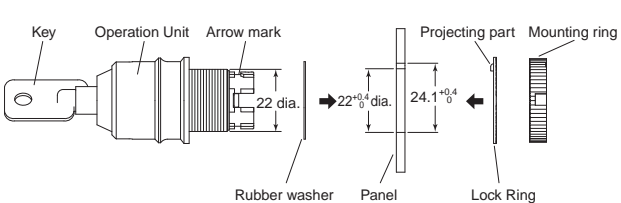
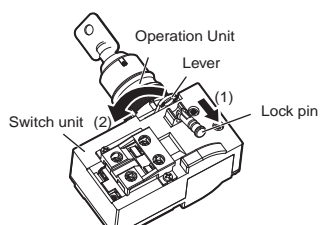

Mounting to the Panel

| (1) Preparing the Panel | (3) Mounting the Switch unit on the Operation unit |
|---|--|
| <ul style="list-style-type: none"> The panel dimensions are shown below. Recommended panel thickness: 1 to 5 mm.  <ul style="list-style-type: none"> A Lock Ring is provided as a standard feature. When painting or coating the panel, make sure that the specified panel dimensions apply to the panel after painting or coating. | <ul style="list-style-type: none"> When attaching the switch unit, insert and turn the key to total travel position. Before attach the switch unit, confirm the triangle mark on shaft and box are matched.  |
| (2) Mounting the Operation Unit on the Panel | (4) Removing the Switch |
| <ul style="list-style-type: none"> Insert the Operation Unit from the front surface of the panel, insert the Lock Ring and the mounting ring from the terminal side, then tighten the ring. Before tightening, check that the rubber washer is present between the Operation Unit and the panel. Tighten the mounting ring at a torque of 0.98 to 1.96 N·m. When using a Lock Ring, insert the projecting part into the lock slot, and then tighten the mounting ring.  | <ol style="list-style-type: none"> Remove the lock pin from the protrusion on the Switch Unit, and then extract the lock pin from the lever. Move the lever in the direction indicated by the arrow in the following figure, then pull the Operation Unit or the Switch Unit. Since the lever has a hole with an inside diameter of 6.5 mm, the lever can be moved in the specified direction by inserting a screwdriver into the hole and then moving the screwdriver.  |

Safety Precautions

Be sure to read the precautions for **All Pushbutton Switches** in the website at: <http://www.ia.omron.com/>.

Indication and Meaning for Safe Use

| | |
|--|--|
|  DANGER | Indicates an imminently hazardous situation which, if not avoided, is likely to result in serious injury or may result in death. Additionally there may be severe property damage. |
|  CAUTION | Indicates a potentially hazardous situation which, if not avoided, may result in minor or moderate injury or in property damage. |
| Precautions for Safe Use | Supplementary comments on what to do or avoid doing, to use the product safely. |
| Precautions for Correct Use | Supplementary comments on what to do or avoid doing, to prevent failure to operate, or undesirable effect on product performance. |

DANGER

Always verify the operation of the safety functions before starting the system. Not do so may result that the safety functions may not be performed as expected if wiring or settings are incorrect or the Switch have failed. The controlled system may continue to operate and possibly resulting in injury or death.



CAUTION

If the Operation Unit is separated from the Switch Unit, the equipment will not stop, creating a hazardous condition.

Secure the lever on the Switch Unit by using the Lock pin so that the Operation Unit cannot be easily separated from the Switch Unit.



[When the slide key is used]

The machine may start to operate accidentally and cause an injury. Do not disable the device by using the spare door Switch operation key or spare key while the door is open.



[When the outer-fence Switch or inner-fence Switch is used]

The machine may start to operate accidentally and cause an injury. Do not disable the inner-fence Switch or outer-fence Switch by using the spare key.



Precautions for Safe Use

Installation Environment

- Do not use the switch in locations where explosive or flammable gasses may be present.
- Do not use the switch submerged in oil or water or in locations continuously subject to splashes of oil or water. Doing so may result in oil or water entering the switch.

Wiring

- Connect the fuse to the Switch in series to prevent it from short circuit damage. The value of the breaking current of the fuse must be increased to cover the rated current by 150 to 200%.
- Always make sure that the power is turned OFF before wiring the Switch.
Also, do not touch the terminals or other current-carrying ports while power is being supplied. Electric shock may occur.
- Mount the Switch unit in accordance with the specifications of the contacts. Use an NC contact for the safety circuit. Check the safety of operation before use. The device may fail to operate normally.
- Mount the operation unit in accordance with the operation specifications. Check the safety of operation before use. The device may fail to operate normally.
- Be sure to install a protect after the wiring. Do not put the electric power when protect is opened.

Installation

- Do not drop the Switch. Doing so may prevent the Switch from functioning to its full capability.
- Make sure the Switch is mounted securely to prevent it from falling off. Otherwise injury may result.
- Mount the Operation Key so that it will not come into contact with persons in the area when the door is opened and closed. Injury may result.
- Do not use a Switch as a stopper. Otherwise, the switch may be damaged and may not operate properly.
- Be sure to use the supplied Lock Ring. Otherwise, the switch may rotate and may not operate properly.

Others

- Do not attempt to disassemble or modify the Switch. Doing so may cause the Switch to malfunction.
- The durability of the Switch is greatly influenced by the switching conditions. Always test the switch under actual working conditions before application and use it in a switching circuit for which there are no problems with performance.
- The user must not maintain or repair equipment incorporating the Switch. Contact the manufacturer of the equipment for any maintenance or repairs required.

Precautions for Correct Use

Operating Environment

- The Switch is intended for indoor use only.
- Do not use the Switch outdoor, or the Switch will malfunction.
- Do not use the Switch in the atmosphere of hazardous gases (H₂S, SO₂, NH₃, HNO₃, Cl₂, etc.) or high temperature and humidity, or it will cause the imperfect closing of the contacts or the breakage thereof stemming from corrosion.
- Do not use the Switch under any of the conditions mentioned below.
 - Frequent temperature range.
 - High humidity or dew condensation may be generated.
 - Where the Switch is subject to severe vibration.
 - Where the metal dust, oil, or chemical is sprayed inside the door.
 - Where thinner is applied.

Switch unit mounting

- Operation unit can be adjusted to any of the four directions.
- Do not remove the switch unit while energizing. Otherwise the machine might mis-operate.

Storage

- Do not store the Switch where corrosive gases (e.g., H₂S, SO₂, NH₃, HNO₃, or Cl₂) or dust is present, or in locations subject to high temperature or high humidity.

Mounting

- Loose screws may result in malfunction.
Be sure to tighten each screw of the Switch properly.

| | |
|------------------------------|---------------|
| Switch terminal screw (M3.5) | 0.6 to 0.8N-m |
| Solenoid terminal screw (M3) | 0.4 to 0.5N-m |
| Protect mounting screw (M3) | 0.5 to 0.7N-m |

- Do not tighten the mounting ring more than necessary using tools such as pointed-nose pliers. Doing so will damage the mounting ring. The tightening torque is 0.98 to 1.96 N-m.

Lock pin

- Mount the lock pin to prevent the operation unit from coming off the switch unit.
- Mounting the lock pin
 - (1) Confirm that the lever is on the "LOCK" position and then insert the lock pin into the hole of the lever.
 - (2) Push the lock pin into the protrusion on the switch unit.

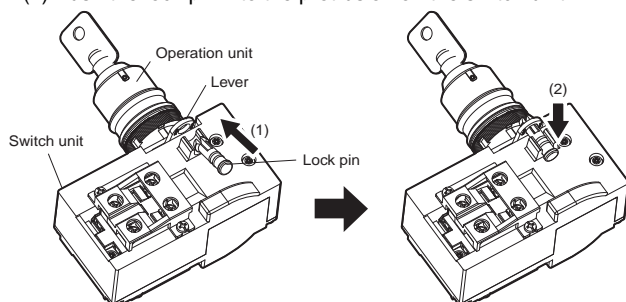

Solenoid lock

- It may not be possible to unlock the switch if there is a weight placed on the key.
Return the key to FP, HP or TTP when switch is unlocked.

Wiring

- Adequate lead wire size is AWG20 to 18 (0.5 to 0.75mm²).
- For the crimp terminal size, refer to the following figure.



- Do not pull a lead wire with excessive force. Disconnection will be caused.
- Do not bend a cable repeatedly.
- When a cable is bent in connection, the bend radius should be R45 mm or more so as not to damage the insulation and sheath of the cable. A fire and a leakage of current may be caused.
- Apply load current not to exceed the rated value.

Others

- Perform maintenance inspections periodically.
- Do not use the key switch to stop/start the machine.
- Mode switching by key must be performed by the operator specified in the operating manual.

Terms and Conditions Agreement

Read and understand this catalog.

Please read and understand this catalog before purchasing the products. Please consult your OMRON representative if you have any questions or comments.

Warranties.

(a) Exclusive Warranty. Omron's exclusive warranty is that the Products will be free from defects in materials and workmanship for a period of twelve months from the date of sale by Omron (or such other period expressed in writing by Omron). Omron disclaims all other warranties, express or implied.

(b) Limitations. OMRON MAKES NO WARRANTY OR REPRESENTATION, EXPRESS OR IMPLIED, ABOUT NON-INFRINGEMENT, MERCHANTABILITY OR FITNESS FOR A PARTICULAR PURPOSE OF THE PRODUCTS. BUYER ACKNOWLEDGES THAT IT ALONE HAS DETERMINED THAT THE PRODUCTS WILL SUITABLY MEET THE REQUIREMENTS OF THEIR INTENDED USE.

Omron further disclaims all warranties and responsibility of any type for claims or expenses based on infringement by the Products or otherwise of any intellectual property right. (c) Buyer Remedy. Omron's sole obligation hereunder shall be, at Omron's election, to (i) replace (in the form originally shipped with Buyer responsible for labor charges for removal or replacement thereof) the non-complying Product, (ii) repair the non-complying Product, or (iii) repay or credit Buyer an amount equal to the purchase price of the non-complying Product; provided that in no event shall Omron be responsible for warranty, repair, indemnity or any other claims or expenses regarding the Products unless Omron's analysis confirms that the Products were properly handled, stored, installed and maintained and not subject to contamination, abuse, misuse or inappropriate modification. Return of any Products by Buyer must be approved in writing by Omron before shipment. Omron Companies shall not be liable for the suitability or unsuitability or the results from the use of Products in combination with any electrical or electronic components, circuits, system assemblies or any other materials or substances or environments. Any advice, recommendations or information given orally or in writing, are not to be construed as an amendment or addition to the above warranty.

See <http://www.omron.com/global/> or contact your Omron representative for published information.

Limitation on Liability: Etc.

OMRON COMPANIES SHALL NOT BE LIABLE FOR SPECIAL, INDIRECT, INCIDENTAL, OR CONSEQUENTIAL DAMAGES, LOSS OF PROFITS OR PRODUCTION OR COMMERCIAL LOSS IN ANY WAY CONNECTED WITH THE PRODUCTS, WHETHER SUCH CLAIM IS BASED IN CONTRACT, WARRANTY, NEGLIGENCE OR STRICT LIABILITY.

Further, in no event shall liability of Omron Companies exceed the individual price of the Product on which liability is asserted.

Suitability of Use.

Omron Companies shall not be responsible for conformity with any standards, codes or regulations which apply to the combination of the Product in the Buyer's application or use of the Product. At Buyer's request, Omron will provide applicable third party certification documents identifying ratings and limitations of use which apply to the Product. This information by itself is not sufficient for a complete determination of the suitability of the Product in combination with the end product, machine, system, or other application or use. Buyer shall be solely responsible for determining appropriateness of the particular Product with respect to Buyer's application, product or system. Buyer shall take application responsibility in all cases.

NEVER USE THE PRODUCT FOR AN APPLICATION INVOLVING SERIOUS RISK TO LIFE OR PROPERTY OR IN LARGE QUANTITIES WITHOUT ENSURING THAT THE SYSTEM AS A WHOLE HAS BEEN DESIGNED TO ADDRESS THE RISKS, AND THAT THE OMRON PRODUCT(S) IS PROPERLY RATED AND INSTALLED FOR THE INTENDED USE WITHIN THE OVERALL EQUIPMENT OR SYSTEM.

Programmable Products.

Omron Companies shall not be responsible for the user's programming of a programmable Product, or any consequence thereof.

Performance Data.

Data presented in Omron Company websites, catalogs and other materials is provided as a guide for the user in determining suitability and does not constitute a warranty. It may represent the result of Omron's test conditions, and the user must correlate it to actual application requirements. Actual performance is subject to the Omron's Warranty and Limitations of Liability.

Change in Specifications.

Product specifications and accessories may be changed at any time based on improvements and other reasons. It is our practice to change part numbers when published ratings or features are changed, or when significant construction changes are made. However, some specifications of the Product may be changed without any notice. When in doubt, special part numbers may be assigned to fix or establish key specifications for your application. Please consult with your Omron's representative at any time to confirm actual specifications of purchased Product.

Errors and Omissions.

Information presented by Omron Companies has been checked and is believed to be accurate; however, no responsibility is assumed for clerical, typographical or proofreading errors or omissions.

2022.1

In the interest of product improvement, specifications are subject to change without notice.

OMRON Corporation
Industrial Automation Company

<http://www.ia.omron.com/>

(c)Copyright OMRON Corporation 2022 All Right Reserved.