

# GT13 Series

— Compact Coaxial Cable Connectors —

〈In-line type, Board type〉

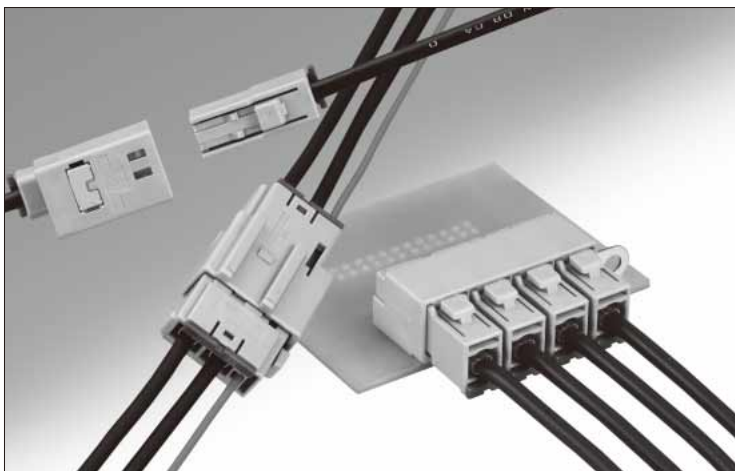

## ■ Features

- **Cost performance:**  
Signal wires and shield wires can be crimped in one step.
- **Space-saving design**  
Smaller than GT5 Series.

## ■ Applications

For car TV, radio antenna, etc.

## F Terminal

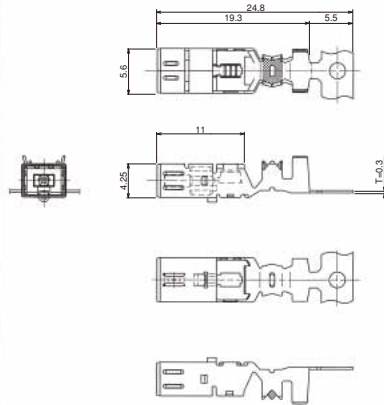

Part No.	HRS No.	Material / Finish or color	Conductor size	Insulator outer diameter	Jacket outer diameter	Sales unit	RoHS
GT13-2428/1.6-2.9SCF(55)	763-0001-3 55	Insulator : PBT/Dark gray Center terminal : Copper alloy /Tin plating Outer terminal : Copper alloy /Tin plating	AWG#24~28	φ1.5~2.0	φ2.7~3.4	3,000 pcs/reel	○
GT13-30/1.6-2.9SCF(55)	763-0012-0 55		AWG#30				
GT13-2428/F4-5SCF(55)	763-0051-1 55		AWG#24~28	φ3.0~3.6	φ4.6~5.0	2,200 pcs/reel	
GT13-30/F4-5SCF(55)	763-0067-1 55		AWG#30				

## M Terminal

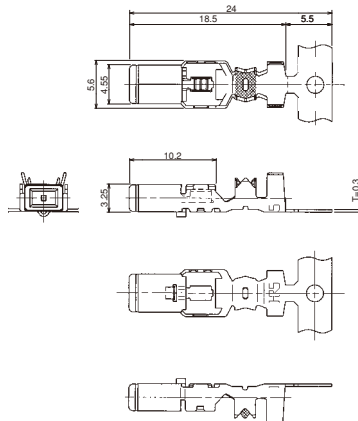

Part No.	HRS No.	Material / Finish or color	Conductor size	Insulator outer diameter	Jacket outer diameter	Sales unit	RoHS
GT13-2428/1.6-2.9PCF(70)	763-0002-6 70	Insulator : PBT/Dark gray Center terminal : Copper alloy /Tin plating Outer terminal : Copper alloy /Tin plating	AWG#24~28	φ1.5~2.0	φ2.7~3.4	4,000 pcs/reel	○
GT13-30/1.6-2.9PCF(70)	763-0041-8 70		AWG#30				
GT13-2428/F4-5PCF(70)	763-0054-0 70		AWG#24~28	φ3.0~3.6	φ4.6~5.0	2,200 pcs /reel	
GT13-30/F4-5PCF(70)	763-0066-9 70		AWG#30				

GT5  
GT13  
GT16  
GT19  
GT21  
GT36  
GT43  
GT17  
GT32  
GT25  
KM32  
ZE05  
ZG052  
HM-200  
ZG04W  
T2072L  
FX26  
DF40  
DF40GL  
RH28K  
FH2K  
FH65  
FH40  
FH63  
FH67

Dec.1.2022 Copyright 2022 HIROSE ELECTRIC CO., LTD. All Rights Reserved.

### Low-insertion Force F Terminal

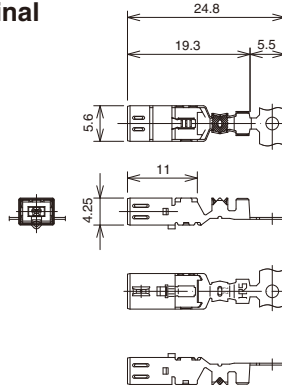

Part No.	HRS No.	Material / Finish or color	Conductor size	Insulator outer diameter	Jacket outer diameter	Sales unit	RoHS
GT13L-2428/1.1-2.2SCF(55)	763-0115-2 55	Insulator : PBT/Dark gray Center terminal : Copper alloy /Tin plating Outer terminal : Copper alloy /Tin plating	AWG#24~28	φ1.0~1.4	φ2.0~2.4	3,000 pcs/reel	○
GT13L-2428/1.6-2.9SCF(55)	763-0132-0 55			φ1.5~2.0	φ2.7~3.4		
GT13L-30/1.6-2.9SCF(55)	763-0098-0 55		AWG#30	φ1.5~2.0	φ2.7~3.4		

### 13S Series

#### F Housing (1 Coaxial)

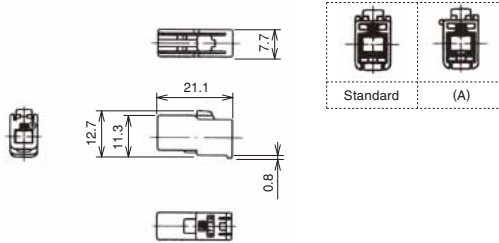

#### ◆ Retainer installed

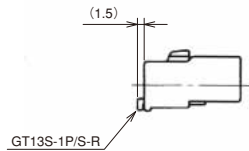

Part No.	HRS No.	Material	Color	Key position	Sales unit	RoHS
GT13S-1S-HU	763-0024-9	PBT	Light gray	Standard	1	○
GT13S-1S-HU(A)	763-0025-1		Brown	(A)		
GT13SN-1S-HU	763-0044-0		Black	Standard		

Dec. 1, 2022 Copyright 2022 HIROSE ELECTRIC CO., LTD., All Rights Reserved.

### M Housing (1 Coaxial)

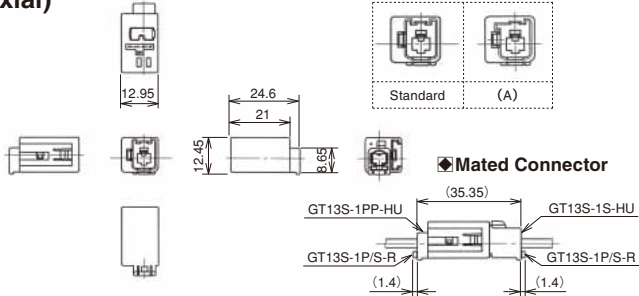

Part No.	HRS No.	Material / Finish	Color	Key position	Sales unit	RoHS
GT13S-1PP-HU	763-0030-1	Housing : PBT	Light gray	Standard	1	○
GT13S-1PP-HU(A)	763-0031-4	Ground terminal : Copper alloy/Tin plating	Brown	(A)		
GT13SN-1PP-HU	763-0006-0 00	Housing : PBT, bracket N type Ground terminal : None	Black	Standard		

### Retainer

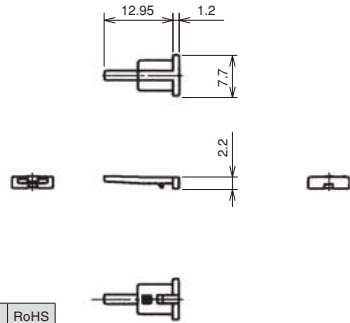

Part No.	HRS No.	Material	Color	Sales unit	RoHS
GT13S-1P/S-R	763-0033-0	PBT	Dark gray	1	○

### F Housing (1 Coaxial) Retainer not required

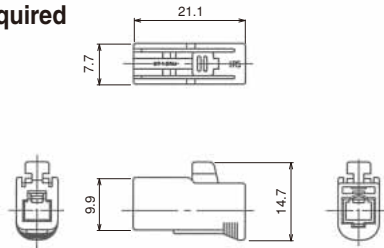

Part No.	HRS No.	Material	Color	Sales unit	RoHS
GT13RM-1S-HU	763-0099-8	PBT	Light gray	1	○



GT5  
 GT13  
 GT16  
 GT19  
 GT21  
 GT36  
 GT43  
 GT17  
 GT32  
 GT25  
 KM37  
 ZE05  
 ZG052  
 HM-200  
 ZG04W  
 T2023  
 FX26  
 DF40  
 DF40GL  
 RH28K  
 FHS2K  
 FHS5  
 FH40  
 FHS3  
 FHS7

## Board Mount type (1 Coaxial)

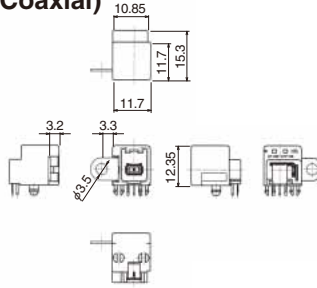

### Recommended Board Dimensions

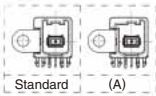
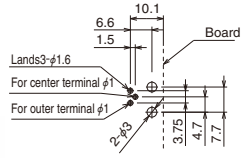

### Mated Connector

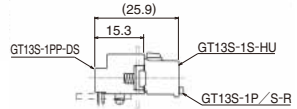

### Recommended Panel Dimensions

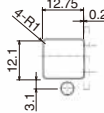

Part No.	HRS No.	Material / Finish	Color	Key position	Sales unit	RoHS
GT13S-1PP-DS	763-0027-7	Housing : PBT Center terminal : Copper alloy /Tin plating Outer terminal : Copper alloy /Tin plating Bracket hardware : Copper alloy / Tin plating	Light gray	Standard	1	○
GT13S-1PP-DS(A)	763-0028-0		Brown	(A)		

## GT13SC Series

### F Connector Power Supply Terminal

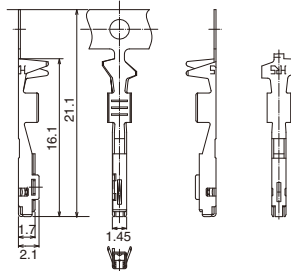
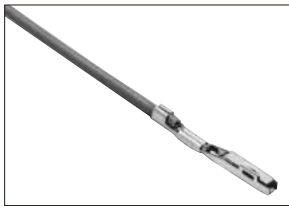

Part No.	HRS No.	Material	Finish	Conductor size	Insulator outer diameter	Sales unit	RoHS
GT10A-2022SCF	760-0014-6	Copper alloy	Tin plating	AWG#20~22	φ2.0 or less	8,000 pcs/reel	○

### M Connector Power Supply Terminal

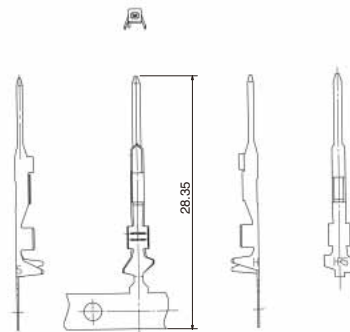
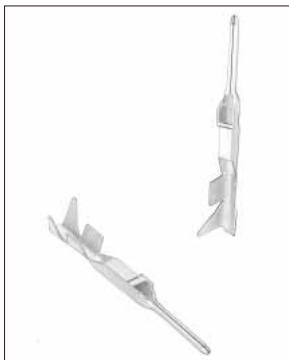

Part No.	HRS No.	Material	Finish	Conductor size	Insulator outer diameter	Sales unit	RoHS
GT10SC-2022PCF	760-0016-1	Copper alloy	Tin plating	AWG#20~22	φ1.5-2.0	7,000 pcs/reel	○
GT10A-2022PCF	760-0015-9				φ2.0 or less	10,000 pcs/reel	

Dec. 1, 2022 Copyright 2022 HIROSE ELECTRIC CO., LTD., All Rights Reserved. GT13 GT16 GT19 FH65 FH40 FH35 FH67

### ■ F Housing (1 Coaxial + 1 Power)

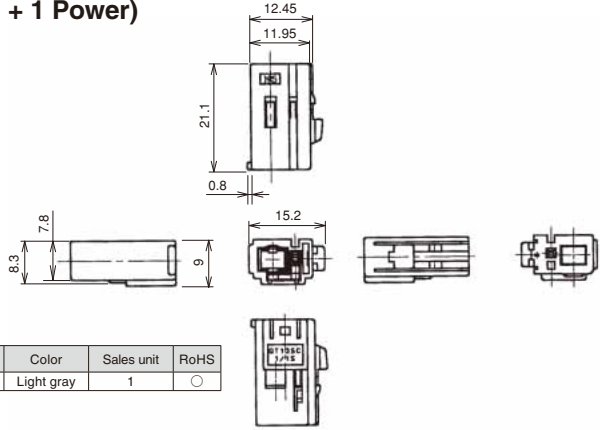
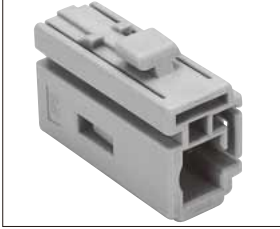

Part No.	HRS No.	Material	Color	Sales unit	RoHS
GT13SC-1/1S-HU	763-0010-4	PBT	Light gray	1	○

\*GT10A-2022SCF is the power supply terminal.

### ● Retainer (Used with : GT13SC-1/1S-HU, GT13SS-1/1S-HU)

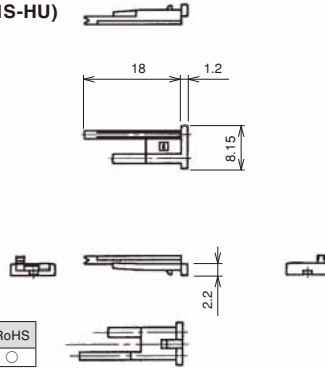

Part No.	HRS No.	Material	Color	Sales unit	RoHS
GT13SC-1/1S-R	763-0011-7	PBT	Dark gray	1	○

### ■ F Housing (1 Coaxial + 1 Power)

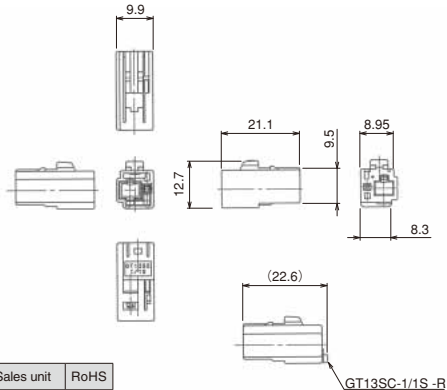

Part No.	HRS No.	Material	Color	Sales unit	RoHS
GT13SS-1/1S-HU	763-0093-1	PBT	Light gray	1	○

\*GT10A-2022SCF is the power supply terminal.

◆ Retainer installed

GT5  
GT13  
GT16  
GT19  
GT21  
GT36  
GT43  
GT17  
GT32  
GT25  
KM37  
ZE05  
ZG052  
HM-200  
ZS04W  
E20723  
FX26  
DF40  
DF40GL  
RH28K  
FH2K  
FH5  
FH40  
FH63  
FH67

Dec.1.2022 Copyright 2022 HIROSE ELECTRIC CO., LTD. All Rights Reserved.

### F Housing (2 Coaxial)

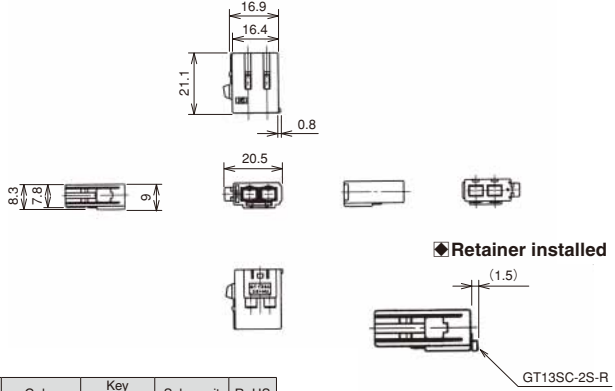

Part No.	HRS No.	Material	Color	Key position	Sales unit	RoHS
GT13SC-2S-HU	763-0014-5	PBT	Light gray	Standard	1	○

### Retainer (Used with : GT13SC-2S-HU, GT13SCN-2PP-HU, GT13SCH-2PP-HU)

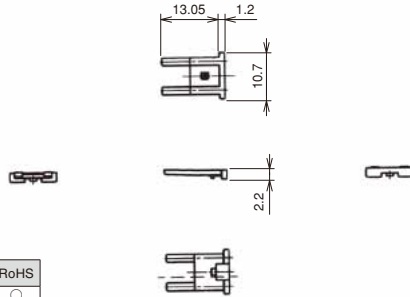
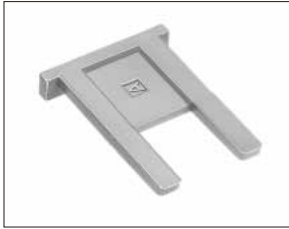

Part No.	HRS No.	Material	Color	Sales unit	RoHS
GT13SC-2S-R	763-0015-8	PBT	Dark gray	1	○

### F Housing (2 Coaxial + 1 Power)

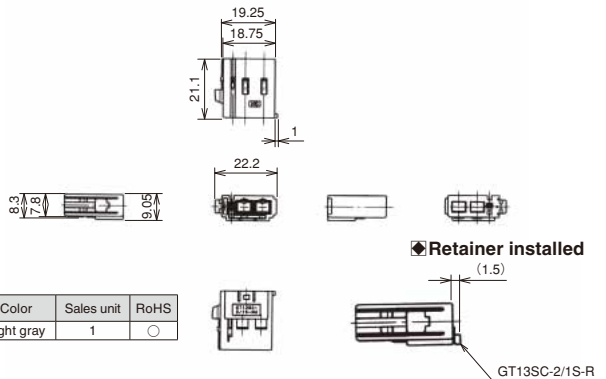

Part No.	HRS No.	Material	Color	Sales unit	RoHS
GT13SC-2/1S-HU	763-0016-0	PBT	Light gray	1	○

\*GT10A-2022SCF is the power supply terminal.

● Retainer (for GT13SC-2/1-HU only)

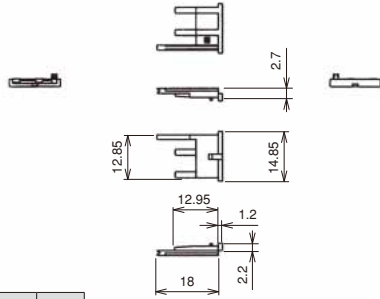

Part No.	HRS No.	Material	Color	Sales unit	RoHS
GT13SC-2/1S-R	763-0017-3	PBT	Dark gray	1	○

■ F Housing (4 Coaxial + 1 Power)

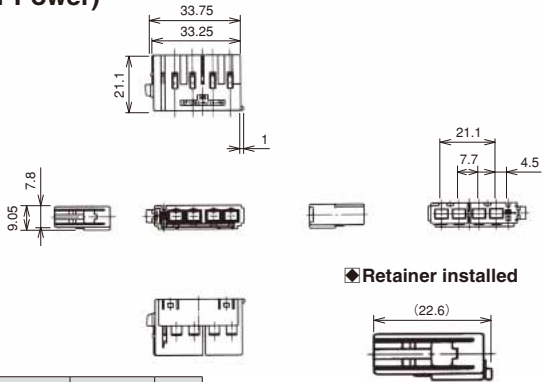

◆ Retainer installed

Part No.	HRS No.	Material	Color	Sales unit	RoHS
GT13SC-4/1S-HU	763-0021-0	PBT	Light gray	1	○
GT13SC-4/1S-HU(A)	763-0022-3		Brown		

\*GT10A-2022SCF is the power supply terminal.

● Retainer (for GT13SC-4/1S-HU only)

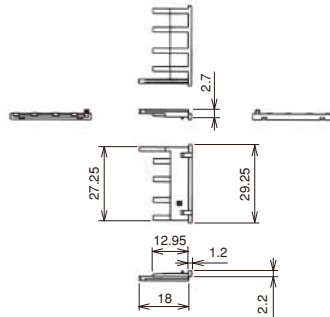
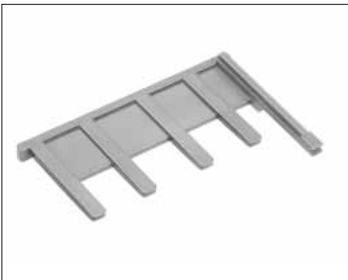

Part No.	HRS No.	Material	Color	Sales unit	RoHS
GT13SC-4/1S-R	763-0023-6	PBT	Dark gray	1	○



GT5  
GT13  
GT16  
GT19  
GT21  
GT36  
GT43  
GT17  
GT32  
GT25  
KM32  
ZE05  
ZG05/2  
HM-200  
ZG04W  
T20/23  
FX26  
DF40  
DF40GL  
RH28K  
FH2K  
FH65  
FH40  
FH63  
FH67

Dec.1.2022 Copyright 2022 HIROSE ELECTRIC CO., LTD. All Rights Reserved.

■ M Housing (1 Coaxial + 1 Power)

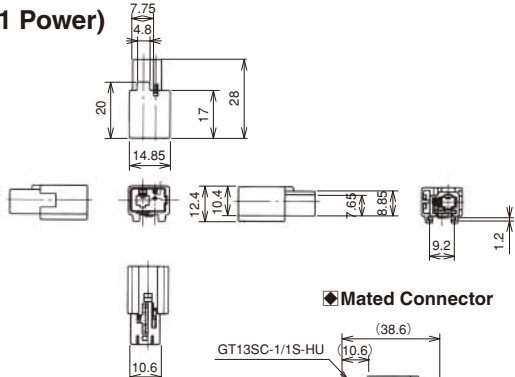

Part No.	HRS No.	Material	Color	Sales unit	RoHS
GT13SCN-1/1P-HU	763-0036-8	PBT	Light gray	1	○

\*GT10SC-2022PCF or GT10A-2022PCF is the power supply terminal.

● Retainer

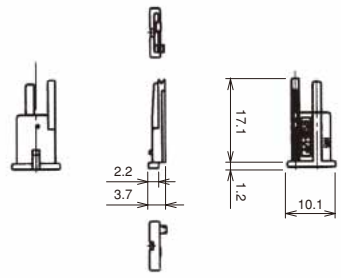

Part No.	HRS No.	Material	Color	Sales unit	RoHS
GT13SC-1/1P-R	763-0039-6	PBT	Dark gray	1	○

■ M Housing (1 Coaxial + 1 Power)

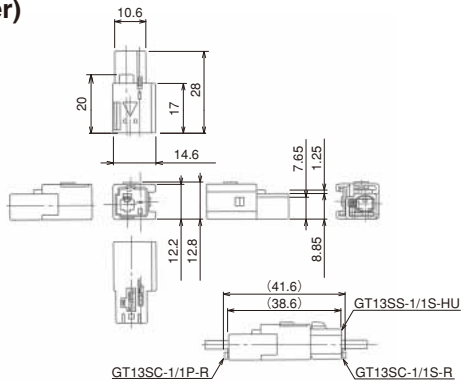

Part No.	HRS No.	Material	Color	Sales unit	RoHS
GT13SSN-1/1P-HU	763-0092-9	PBT	Light gray	1	○

\*GT10SC-2022PCF or GT10A-2022PCF is the power supply terminal.

Dec. 1, 2022 Copyright 2022 HIROSE ELECTRIC CO., LTD. All Rights Reserved.

### ■ M Housing (2 Coaxial)

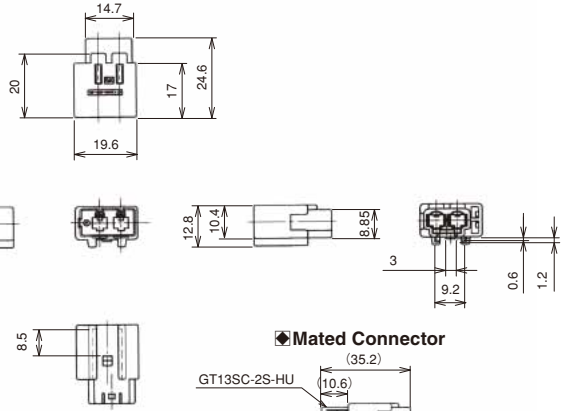

Part No.	HRS No.	Material	Color	Sales unit	RoHS
GT13SCN-2PP-HU	763-0046-1	PBT	Light gray	1	○

### ■ M Housing (2 Coaxial)

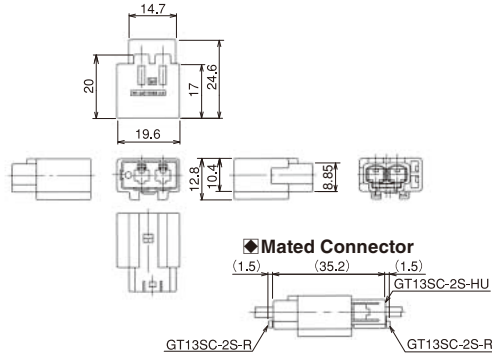

Part No.	HRS No.	Material	Color	Sales unit	RoHS
GT13SCH-2PP-HU	763-0072-1	PBT	Light gray	1	○

### ■ M Housing (2 Coaxial + 1 Power)

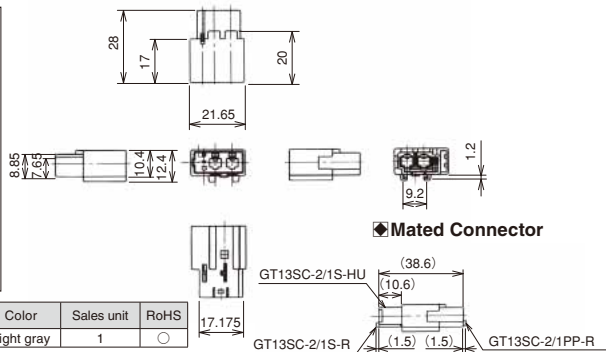

Part No.	HRS No.	Material	Color	Sales unit	RoHS
GT13SCN-2/1PP-HU	763-0038-3	PBT	Light gray	1	○

\*GT10SC-2022PCF or GT10A-2022PCF is the power supply terminal.

GT5  
GT13  
GT16  
GT19  
GT21  
GT36  
GT43  
GT17  
GT32  
GT25  
KM32  
ZE05  
ZG052  
HM-200  
ZE64W  
T2023  
FX26  
DF40  
DF40GL  
FH28K  
FH32K  
FH65  
FH40  
FH33  
FH67

Dec.1.2022 Copyright 2022 HIROSE ELECTRIC CO., LTD. All Rights Reserved.

● Retainer (for GT13SCN-2/1PP-HU only)

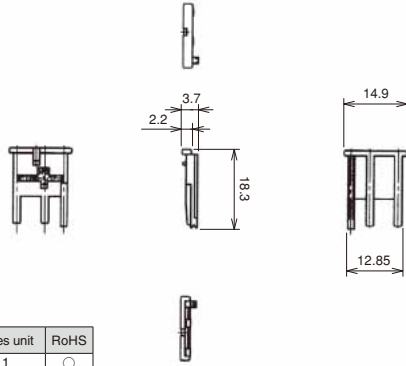
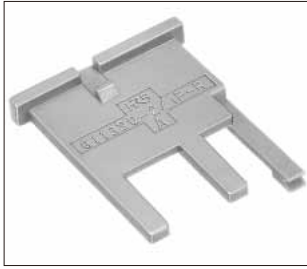

Part No.	HRS No.	Material	Color	Sales unit	RoHS
GT13SC-2/1PP-R	763-0040-5	PBT	Dark gray	1	○

■ M Housing (4 Coaxial + 1 Power)

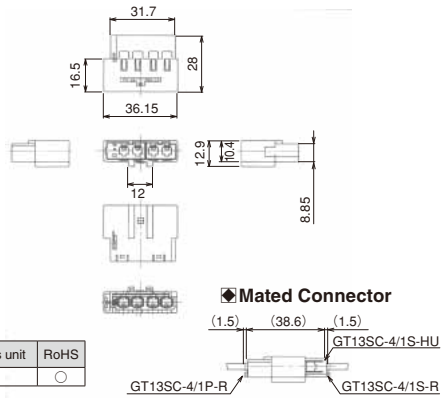

Part No.	HRS No.	Material	Color	Sales unit	RoHS
GT13SCH-4/1PP-HU	763-0060-2	PBT	Light gray	1	○

\*GT10SC-2022PCF or GT10A-2022PCF is the power supply terminal.

● Retainer

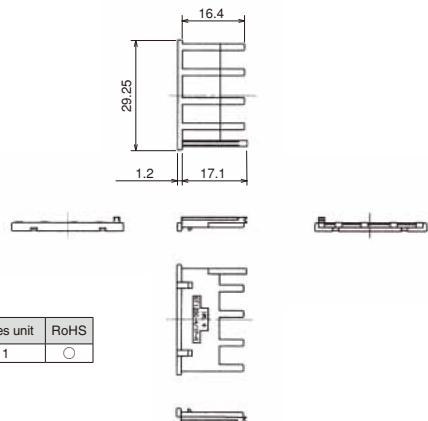

Part No.	HRS No.	Material	Color	Sales unit	RoHS
GT13SC-4/1P-R	763-0061-5	PBT	Dark gray	1	○

Dec. 1, 2022 Copyright 2022 HIROSE ELECTRIC CO., LTD., All Rights Reserved. GT13 GT16 GT19 FH65 FH40 FH35 FH67

### ■ Board Mount type (1 Coaxial + 1 Power)

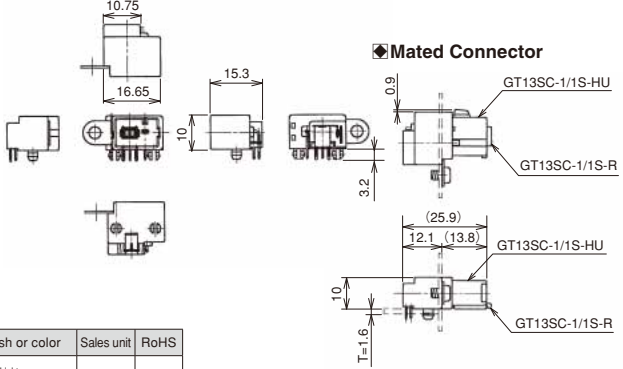

Part No.	HRS No.	Material / Finish or color	Sales unit	RoHS
GT13SC-1/1PP-DS(70)	763-0009-5 70	Housing : PBT / Light gray Center terminal : Copper alloy / Tin plating Outer terminal : Copper alloy / Tin plating Power terminal : Copper alloy / Tin plating Bracket hardware : Copper alloy / Tin plating	1	○

#### ◆ Recommended Board Dimensions

#### ◆ Recommended Panel Dimensions

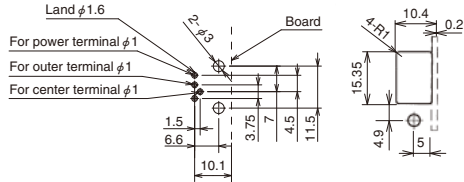

### ■ Board Mount type (2 Coaxial)

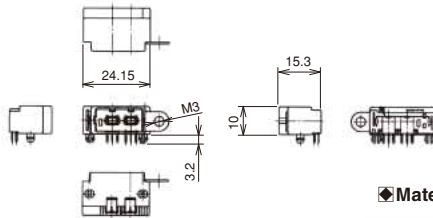

Part No.	HRS No.	Material	Color	Key position	Sales unit	RoHS
GT13SC-2/2P-DS(71)	763-0013-2 71	Housing : PBT Center terminal : Copper alloy / Tin plating Outer terminal : Copper alloy / Tin plating Bracket hardware : Copper alloy / Tin plating	Light gray	Standard	1	○

#### ◆ Mated Connector

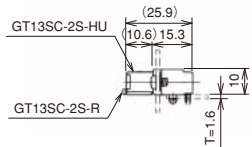

#### ◆ Recommended Board Dimensions

#### ◆ Recommended Panel Dimensions

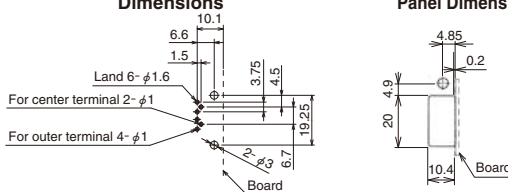

GT5  
GT13  
GT16  
GT19  
GT21  
GT36  
GT43  
GT17  
GT32  
GT25  
KM37  
ZE05  
ZE05J2  
HM-200  
ZE04W  
IT202K  
EK26  
DF40  
DF40GL  
FH28K  
FH2K  
FH5  
FH40  
FH63  
FH67

### Board Mount type (2 Coaxial + 1 Power)



#### Recommended Board Dimensions

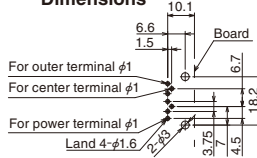

#### Recommended Panel Dimensions

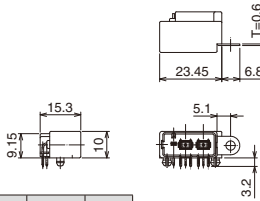
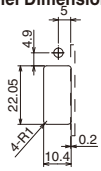

#### Mated Connector

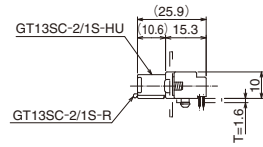

Part No.	HRS No.	Material / Finish or color	Sales unit	RoHS
GT13SC-2/1PP-DS(70)	763-0018-6 70	Housing : PBT Light gray Center terminal : Copper alloy / Tin plating Outer terminal : Copper alloy / Tin plating Power terminal : Copper alloy / Tin plating Bracket hardware : Copper alloy / Tin plating	1	○

### Board Mount type (4 Coaxial + 1 Power)

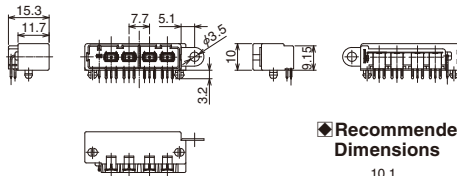
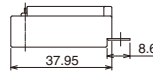

#### Recommended Board Dimensions

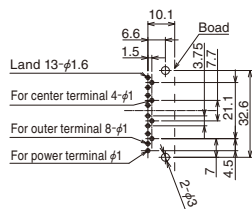

#### Recommended Panel Dimensions

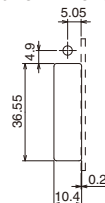

Part No.	HRS No.	Material	Color	Key position	Sales unit	RoHS
GT13SC-4/1PP-DS(70)	763-0019-9 70	Housing : PBT Center terminal : Copper alloy / Tin plating Outer terminal : Copper alloy / Tin plating Power terminal : Copper alloy / Tin plating Bracket hardware : Copper alloy / Tin plating	Light gray	Standard	1	○
GT13SC-4/1PP-DS(A)(70)	763-0020-8 70		Brown	(A)		

#### Mated Connector

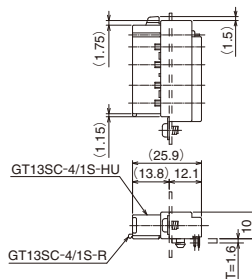

Dec.1.2022 Copyright 2022 HIROSE ELECTRIC CO., LTD. All Rights Reserved.

## GT13SH Series

### Power Supply Terminals

#### F Connector Terminals

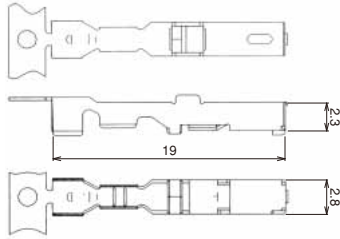

Part No.	HRS No.	Material	Finish	Conductor size	Jacket outer diameter	Sales unit	RoHS
GT7-2022SCF(70)	757-0001-1 70	Copper alloy	Tin plating	AWG#20~22	φ1.4~2.4	5,000 pcs/reel	○
GT7A-2022SCF(70)	757-0003-7 70				φ2.6~3.1		

Note 1 : This product is sold in units of reels. (See the table above for number of pcs per reel.)  
 Note 2 : This product cannot be used with housings from other manufacturers.

#### M Connector Terminals

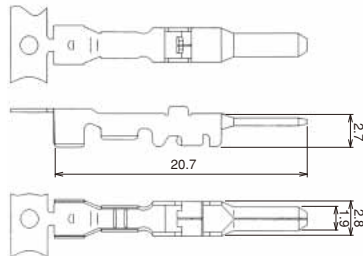

Part No.	HRS No.	Material	Finish	Conductor size	Jacket outer diameter	Sales unit	RoHS
GT7-2022PCF(70)	757-0002-4 70	Brass	Tin plating	AWG#20~22	φ1.4~2.4	5,000 pcs/reel	○
GT7A-2022PCF(70)	757-0004-0 70				φ2.6~3.1		

Note 1 : This product is sold in units of reels. (See the table above for number of pcs per reel.)  
 Note 2 : This product cannot be used with housings from other manufacturers.

#### F Housing (1 Coaxial + 1 Power)

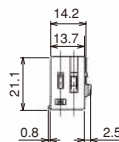

Part No.	HRS No.	Material	Color	Sales unit	RoHS
GT13SH-1/1S-HU	763-0048-7	PBT	Light gray	1	○
GT13SH-1/1S-HU(A)	763-0059-3		Brown		



\*GT7-2022SCF (70) or GT7A-2022SCF (70) is the power supply terminal.

Dec. 1, 2022. Copyright 2022 HIROSE ELECTRIC CO., LTD., All Rights Reserved. GT5 GT13 GT16 GT19 FH65 FH40 FH35 FH67

## ● Retainer

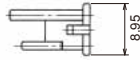
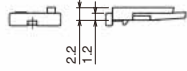
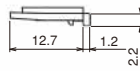

Part No.	HRS No.	Material	Color	Sales unit	RoHS
GT13SH-1/1S-R	763-0049-0	PBT	Dark gray	1	○

## ■ F Housing (2 Coaxial + 1 Power)

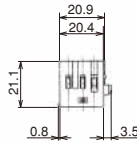

Part No.	HRS No.	Material	Color	Sales unit	RoHS
GT13SH-2/1S-HU	763-0065-6	PBT	Light gray	1	○
GT13SHB-2/1S-HU	763-0131-0				

\*GT7-2022SCF (70) or GT7A-2022SCF (70) is the power supply terminal.

## ● Retainer

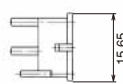
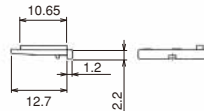
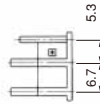

Part No.	HRS No.	Material	Color	Sales unit	RoHS
GT13SH-2/1S-R	763-0064-3	PBT	Dark gray	1	○

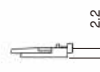

Dec. 1, 2022 Copyright 2022 HIROSE ELECTRIC CO., LTD., All Rights Reserved.  
 GT13 GT16 GT19 GT13 FH65 FH40 FH35 FH67

### ■ M Housing (1 Coaxial + 1 Power)

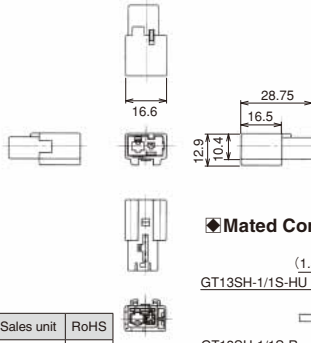

Part No.	HRS No.	Material	Color	Sales unit	RoHS
GT13SH-1/1P-HU	763-0055-2	PBT	Light gray	1	○

\*GT7-2022SPCF (70) or GT7A-2022PCF (70) is the power supply terminal.

#### ◆ Mated Connector

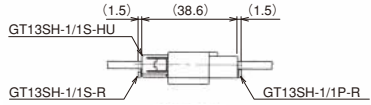

### ■ M Housing (1 Coaxial + 1 power)

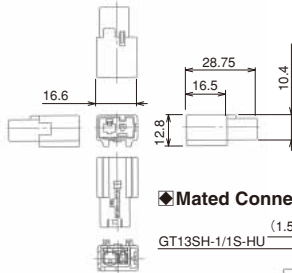

Part No.	HRS No.	Material	Color	Sales unit	RoHS
GT13SHN-1/1PP-HU	763-0078-8	PBT	Light gray	1	○

\*GT7-2022SPCF (70) or GT7A-2022PCF (70) is the power supply terminal.

#### ◆ Mated Connector

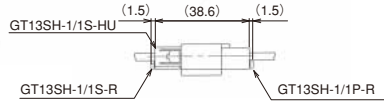

### ● Retainer

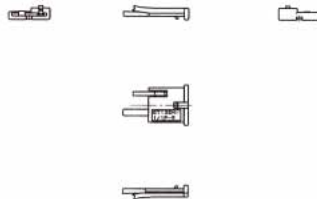
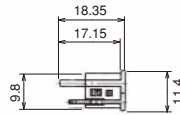

Part No.	HRS No.	Material	Color	Sales unit	RoHS
GT13SH-1/1P-R	763-0056-5	PBT	Dark gray	1	○



## ■ M Housing (2 Coaxial + 1 Power)

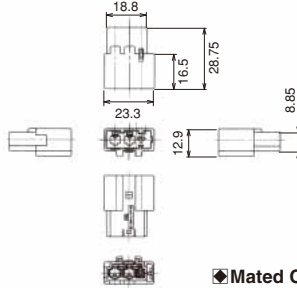

Part No.	HRS No.	Material	Color	Sales unit	RoHS
GT13SH-2/1PP-HU	763-0076-2	PBT	Light gray	1	○

\*GT7-2022PCF (70) or GT7A-2022PCF (70) is the power supply terminal.

### ◆ Mated Connector

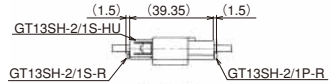

## ● Retainer

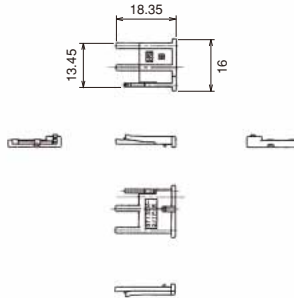

Part No.	HRS No.	Material	Color	Sales unit	RoHS
GT13SH-2/1P-R	763-0077-5	PBT	Dark gray	1	○

## ■ Board Mount type (1 Coaxial)

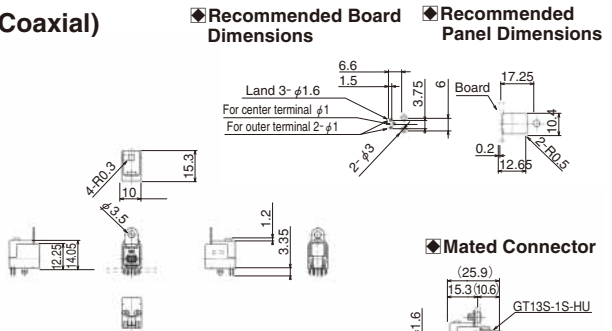

Part No.	HRS No.	Material / Finish or color	Sales unit	RoHS
GT13SHA-1PP-DS	763-0062-8	Housing : PBT/ Light gray Center terminal : Copper alloy /Tin plating Outer terminal : Copper alloy /Tin plating Bracket hardware : Copper alloy / Tin plating	1	○

Dec.1, 2022 Copyright 2022 HIROSE ELECTRIC CO., LTD., All Rights Reserved. GT13 GT16 GT19 FH65 FH40 FH35 FH67

### Board Mount type (1 Coaxial + 1 Power)



#### Recommended Board Dimensions

#### Recommended Panel Dimensions

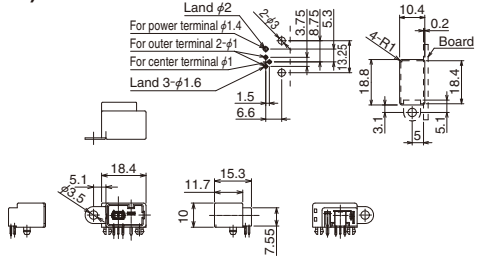

Part No.	HRS No.	Material / Finish or color	Sales unit	RoHS
GT13SH-1/1PP-DS	763-0050-9	Housing : PBT / Light gray Center terminal : Copper alloy / Tin plating Outer terminal : Copper alloy / Tin plating Power terminal : Copper alloy / Tin plating Bracket hardware : Copper alloy / Tin plating	1	○

#### Mated Connector

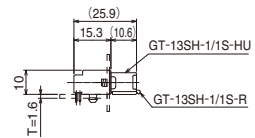

### Board Mount type (1 Coaxial + 1 Power)



#### Recommended Board Dimensions

#### Recommended Panel Dimensions

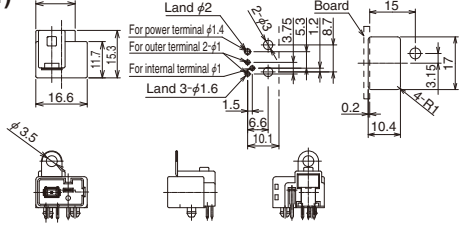

Part No.	HRS No.	Material / Finish	Color	Sales unit	RoHS
GT13SHA-1/1PP-DS	763-0057-8	Housing : PBT Center terminal : Copper alloy / Tin plating Outer terminal : Copper alloy / Tin plating Power terminal : Copper alloy / Tin plating Bracket hardware : Copper alloy / Tin plating	Light gray	1	○

#### Mated Connector

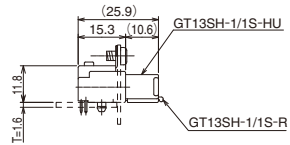

### Board Mount type (1 Coaxial + 1 Power)



#### Recommended Board Dimensions

#### Recommended Panel Dimensions

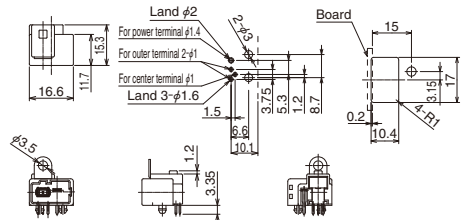

Part No.	HRS No.	Material / Finish	Color	Sales unit	RoHS
GT13SHA-1/1PP-DS(A)	763-0058-0	Housing : PBT Center terminal : Copper alloy / Tin plating Outer terminal : Copper alloy / Tin plating Power terminal : Copper alloy / Tin plating Bracket hardware : Copper alloy / Tin plating	Brown	1	○

#### Mated Connector

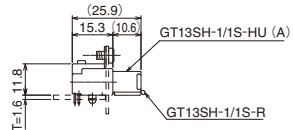

GT5  
 GT13  
 GT16  
 GT19  
 GT21  
 GT36  
 GT43  
 GT17  
 GT32  
 GT25  
 KM37  
 ZS05  
 ZS05/2  
 HH-200  
 ZS04W  
 IT202K  
 FK26  
 DF40  
 DF40GL  
 RH28K  
 FH2K  
 FH5  
 FH40  
 FH63  
 FH67

## Board Mount type (2 Coaxial + 1 Power)



### Recommended Board Dimensions

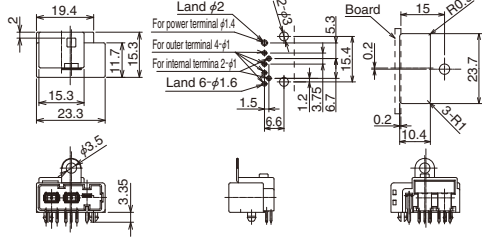

### Recommended Panel Dimensions

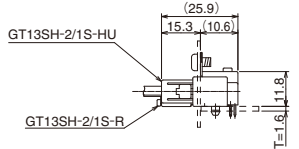

Part No.	HRS No.	Material / Finish or color	Sales unit	RoHS
GT13SHA-2/1PP-DS	763-0063-0	Housing : PB7 Light gray Center terminal : Copper alloy (Tin plating) Outer terminal : Copper alloy (Tin plating) Power terminal : Copper alloy (Tin plating) Bracket hardware : Copper alloy / Tin plating	1	○
GT13SHB-2/1P-DS	763-0125-0			

## Crimping Tools

Please ask your Hirose Electric account representative for a user manual.

### Automatic Crimping Machine



Photo for reference only.  
Subject to change.

Part No. CM-105C

### Specifications

Item	Specifications	Remarks
Press capacity	1.5tons	
Stroke length	30mm	
Number of strokes	200spm (50Hz)	200spm (60Hz)
Weight	75kg	
Motor	0.2kW	AC100V
Crimping speed	2,000-4,000/H	

\*Terminal crimp height setting tables are available for each cable type. Please contact your Hirose Electric account representative.

Please note that we will need to define new crimp heights for novel cables and this may take a few days.

\*Requires special reel stand.

## Harness Tools

HRS No.	Applicable Terminal	Part No.	HRS No.
763-0001-3 55	GT13-2428/1.6-2.9SCF(55)	AP105-GT13-2428/1.6-2.9S	901-5073-1
763-0002-6 70	GT13-2428/1.6-2.9PCF(70)	AP105-GT13-2428/1.6-2.9P	901-5074-7
763-0012-0 55	GT13-30/1.6-2.9SCF(55)	AP105-GT13-30/1.6-2.9S-ID	901-5099-5
763-0041-8 70	GT13-30/1.6-2.9PCF(70)	AP105-GT13-30/1.6-2.9P-ID	901-5118-8
763-0012-0 55	GT13-30/1.6-2.9SCF(55)	AP105-GT13-30/1.6-2.9S	901-5116-2
763-0041-8 70	GT13-30/1.6-2.9PCF(70)	AP105-GT13-30/1.6-2.9P	901-5119-0

Please refer to our cable termination procedure manual for performing terminations.