

High-Speed(25+Gbps) BGA Mezzanine Connectors

IT5 Series

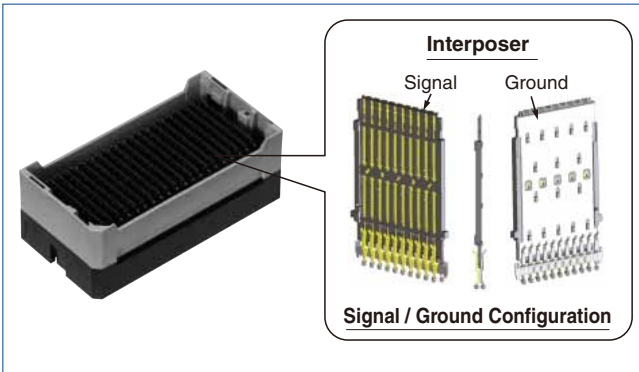
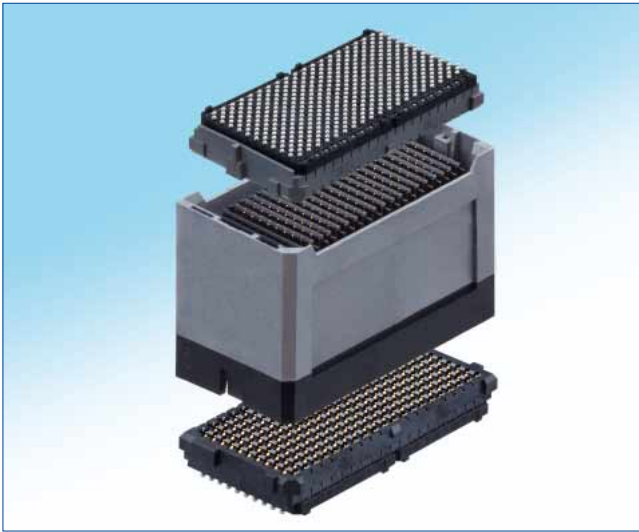

Flexibility

Hirose's IT5 mezzanine connector system is as comfortable in today's data rates of PCIe and XAUI as it is in tomorrow's 25+Gbps systems.

With the ability to transmit differential, single-ended, and power through one package and being stackable from 14 to 40mm, IT5 can solve your interface needs for both current and future generations.

Mechanical features

- Unique 3-piece structure for flexibility
- Stacking heights from 14 to 40mm
- Staggered 1.5mm × 1.75mm ball grid array
- Number of Contacts: 100, 200, & 300 signals + 110% additional grounds
- Differential, single-ended, and power
- Low mating/extracting forces
- Wide misalignment tolerances for multiple connector use
- Pb-free are available
- Excellent reflow solderability

Signal integrity features

Insertion loss to Crosstalk Ratio (ICR)

The ICR performance meets the extrapolated IEEE 802.3ap specification for 16GHz with fully-populated pin assignment, and 25+Gbps differential data transmission requirement.

Return Loss

The differential return loss with vias and 1 inch PCB trace meets the extrapolated IEEE 802.3ap specification beyond 20Gbps.

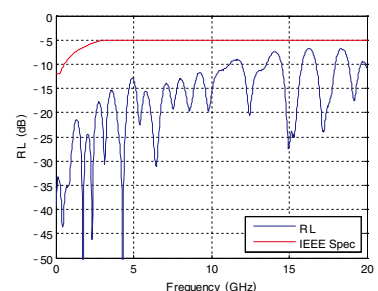
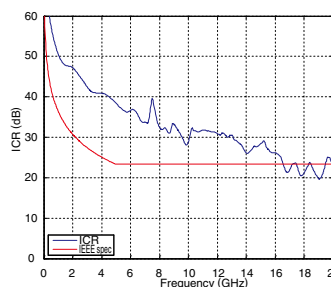

Stacking height variations

Stacking Height	14 mm	15 mm	16 mm	18 mm	19 mm	20 mm	22 mm	23 mm	24 mm	25 mm	26 mm	27 mm	28 mm	29 mm	30 mm	32 mm	33 mm	34 mm	35 mm	36 mm	37 mm	38 mm	39 mm	40 mm
100	✓	✓	✓	✓	✓	✓	✓	✓	✓	✓	✓	✓	✓	✓	✓	✓	✓	✓	✓	✓	✓	✓	✓	✓
200	✓	✓	✓	✓	✓	✓	✓	✓	✓	✓	✓	✓	✓	✓	✓	✓	✓	✓	✓	✓	✓	✓	✓	✓
300	✓	✓	✓	✓	✓	✓	✓	✓	✓	✓	✓	✓	✓	✓	✓	✓	✓	✓	✓	✓	✓	✓	✓	✓

Product Specifications

Rating	Current Rating : 0.2A / pin (Note 1)	Operating Temperature Range : -55°C to +85°C Operating Humidity Range : For relative humidity, 90% max (no condensation is permitted)
	Voltage Rating : 50Vrms	
	Storage Temperature Range : -10°C to +60°C	

Item	Specification	Conditions
1. Insulation Resistance	1000MΩ min.	100V DC
2. Withstanding Voltage	No flashover or insulation breakdown	150V duty for 60 seconds (2mA max leak)
3. Contact Resistance	MATED WITH IT5**-**P-H(**) 50 mΩ MAX (*2) (Height : 14 ~ 16mm) 60 mΩ MAX (*2) (Height : 18 ~ 20mm) 70 mΩ MAX (*2) (Height : 21 ~ 24mm) 80 mΩ MAX (*2) (Height : 25 ~ 28mm) 90 mΩ MAX (*2) (Height : 29 ~ 32mm) 100 mΩ MAX (*2) (Height : 33 ~ 36mm) 110 mΩ MAX (*2) (Height : 37 ~ 40mm) MATED WITH IT3**-**P-H(**) 50 mΩ MAX (*2) (Height : 15 ~ 24mm) 55 mΩ MAX (*2) (Height : 25 ~ 32mm) 60 mΩ MAX (*2) (Height : 33 ~ 40mm)	100mA
4. Vibration	1) No electrical discontinuity of 1μs or more 2) No damage, crack, or loose part	Frequency : 50 to 2000Hz ; power spectrum density : 0.1G ² /Hz for 90 minutes in three directions
5. Cyclic Temperature and Humidity	1) Contact resistance change : 20mΩ or less 2) No damage, crack or loose part	25°C, 80% RH : 60 min dwell time, 30 min ramp time 65°C, 50% RH : 60 min dwell time under 24 cycles
6. Durability (Mating/Un-mating)	1) Contact resistance change : 20mΩ or less 2) No damage, crack or loose part	100 cycles (Height : 18 ~ 40mm) 30 cycles (Height : 14 ~ 16mm)

Note1 : Refer to IT5 derating curves on test report TR636E-20282 for power application.
Note2 : The value of contact resistance includes 2 contact points and the bulk resistance.

Materials / Finish

●Receptacle

Component	Material	Finish & Remarks
Housing (Mounting Side)	LCP	Black , UL 94V-0
Housing (Detachable/Mating Side)	LCP	Gray , UL 94V-0
Locator	LCP	Black , UL 94V-0
Contact	Copper Alloy	Contact Area : Gold (0.76μm) over Nickel (1.5μm) Mounting Area : Gold (0.05μm) over Nickel (1.5μm) Other : Nickel (1.5μm)
Solder Ball	Tin (Pb-Free)	Sn(96.5)-Ag(3)-Cu(0.5)
Tray	Polystyrene	Gray
Pick Up Cap	Stainless steel	300pos
Pick Up Tape	Paper (Nomex)	100pos and 200pos

●Interposer

Component	Material	Finish & Remarks
Guide (Mounting Side)	PBT	Black , UL 94V-0
Guide (Detachable/Mating Side)	LCP	Gray , UL 94V-0
	PBT	Gray , UL 94V-0
Blade (Height : 18 to 40mm)	LCP	Black , UL 94V-0
Contact (Height : 18 to 40mm)	Copper Alloy	Contact Area : Gold (0.76μm) over Nickel (1.5μm)
Ground Shield (Height : 18 to 40mm)	Copper Alloy	Other : Nickel (1.5μm)
Tray	Polypropylene	
PCB (Height : 14 to 16mm)	FR4	Contact Area : Gold (0.76μm) over Nickel (3μm)
		Other : SOLDER RESIST

Product Number Structure

Refer to the chart below when determining the product specifications from the product number.
Please select from the product numbers listed in this catalog when placing orders.

●Receptacle

IT 5 ** - * S - BGA ** (**)**

① ② ③ ④ ⑤ ⑥ ⑦

① Series name: IT5
② Receptacle Type D : Mating Receptacle D* : Mating Receptacle (Customized) HD : Mating Receptacle (+1mm Height) M : Mounting Receptacle M* : Mounting Receptacle (Coustomized) HM : Mounting Receptacle (+1mm Height) Interposer Type Blank : Standard ** : Customized
③ Contact Positions : 100, 200, 300
Connector type ④ S : Receptacle P : Interposer
⑤ BGA : Ball Grid Array

●Interposer

IT 5 ** - * P - ** H ** (**)**

① ② ③ ④ ⑧ ⑥ ⑨

⑥ Package Specification Blank : Standard ** : Customized
⑦ Material and Plating Specification of Mounting Receptacle Housing : Black (37) : Pb-free Solder Sn(96.5)-Ag(3.0)-Cu(0.5) Contact Area : Au(0.76μm)+Ni(1.5μm) Material and Plating Specification of Mating Receptacle Housing : Gray (39) : Pb-free Solder Sn(96.5)-Ag(3.0)-Cu(0.5) Contact Area : Au(0.76μm)+Ni(1.5μm)
⑧ Stacking Height (mm) 14, 18, 22, 25, 28, 32, 35, 38
⑨ Plating Specification of Interposer (03) : Contact Area : Au(0.76μm)+Ni(1.5μm)

Signal Integrity

Pin assignment

For the fully-populated pin assignment, adjacent pins are grouped into differential pairs as shown in the figures below. In the following data, one victim pair and eight aggressor pairs are included.

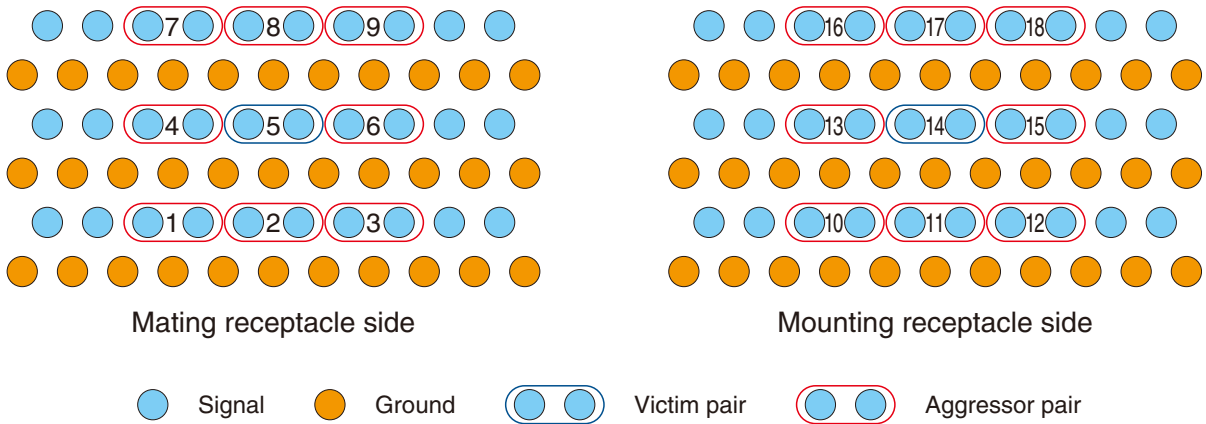

Impedance profile at 15, 30ps rise time (20-80%)

The impedance profiles (of connector only) for the center pair are shown below. The IT5 receptacles are designed with higher impedance to offset the via's low impedance.

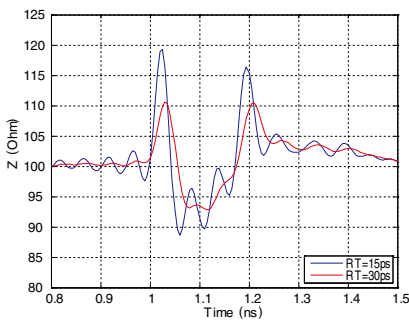

18mm Height

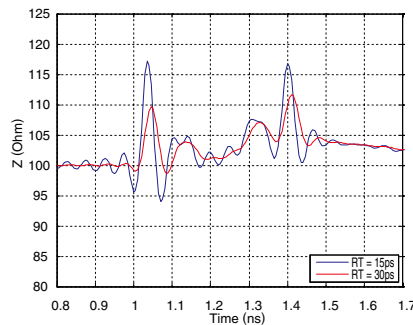

35mm Height

Differential propagation delay

Stacking Height (mm)	18	35
Delay (ps)	112.34	230.64

Differential Insertion Loss

The differential insertion loss is less than -2dB up to 12GHz.

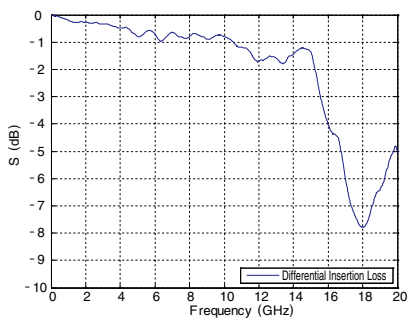

18mm Height

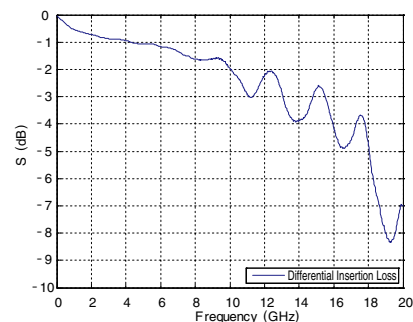

35mm Height

Differential Return Loss

The differential return loss with vias and 1 inch PCB trace meets the extrapolated IEEE 802.3ap specification beyond 20Gbps.

18mm Height

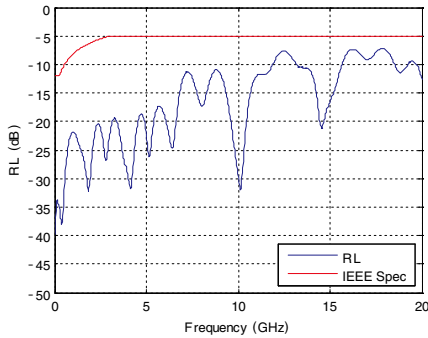

35mm Height

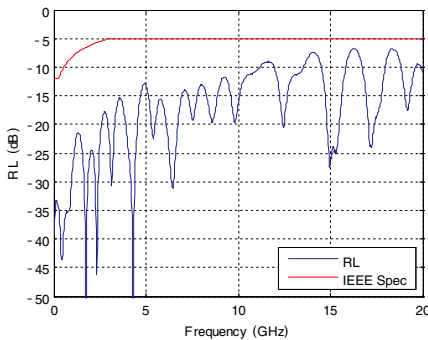

Differential Near-End Crosstalk (NEXT)

The near-end crosstalk at the center pair from surrounding 3 aggressors is shown below. The NEXT is not as critical because TX and RX can be grouped into separate wafers.

18mm Height

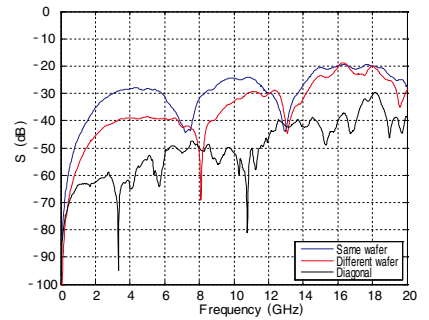

35mm Height

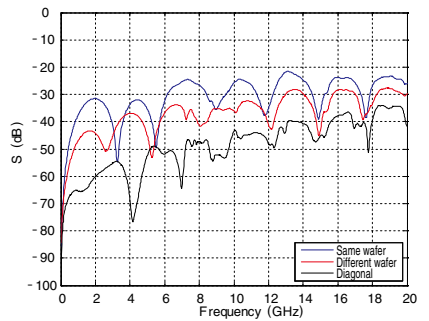

Differential Far-End Crosstalk (FEXT)

Low far-end crosstalk at the center pair from surrounding 3 aggressors is observed. Even lower crosstalk can be achieved by skipping pins.

18mm Height

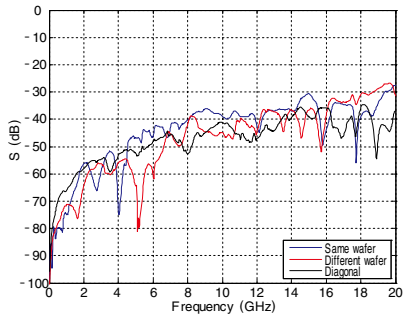

35mm Height

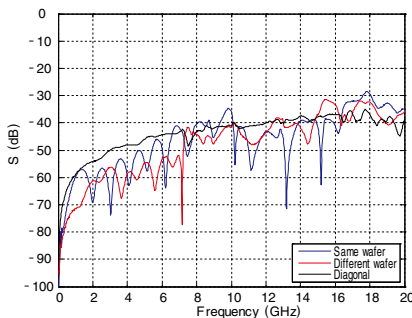

Insertion-Loss-to-Crosstalk-Ratio (ICR) for FEXT

The insertion-loss-to-crosstalk-ratio (ICR) for 8-aggressor FEXT meets the extrapolated IEEE 802.3ap specification up to 16GHz.

18mm Height

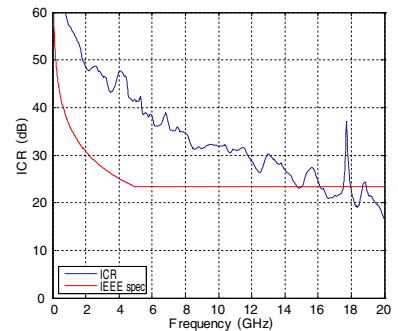

35mm Height

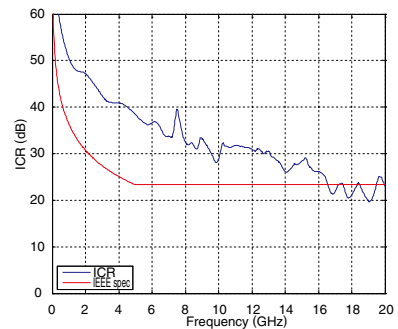

Sep. 1. 2022 Copyright 2022 HIROSE ELECTRIC CO., LTD. All Rights Reserved.

Receptacle

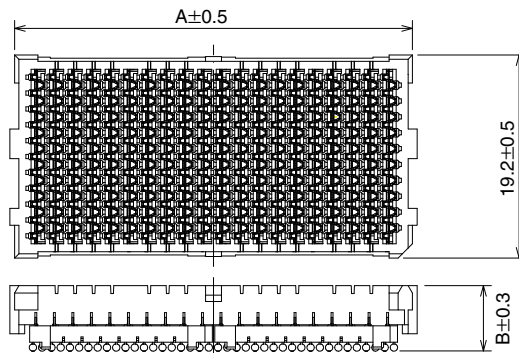
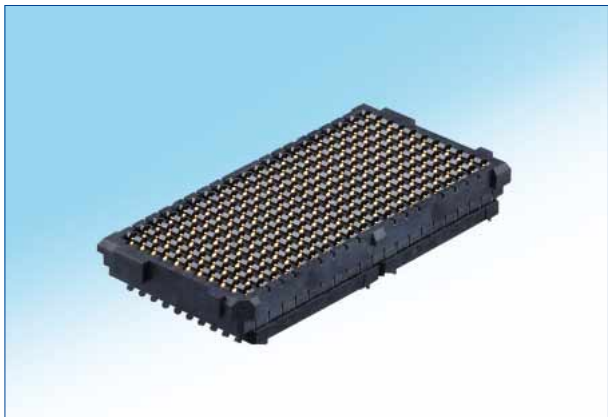

Shown : 200 position mating receptacle, IT5(H)D-200S-BGA(39)

*Unit : mm

Contact Positions	Type	Part No.	HRS No.	A	B
100 (100 signals/110 grounds)	Mating Receptacle	IT5D-100S-BGA(39)	636-1513-0 39	21.0	6
		IT5HD-100S-BGA(39)	636-1521-8 39		7
	Mounting Receptacle	IT5M-100S-BGA(37)	636-1514-2 37		6
		IT5HM-100S-BGA(37)	636-1522-0 37		7
200 (200 signals/220 grounds)	Mating Receptacle	IT5D-200S-BGA(39)	636-1501-0 39	38.5	6
		IT5HD-200S-BGA(39)	636-1523-3 39		7
	Mounting Receptacle	IT5M-200S-BGA(37)	636-1502-3 37		6
		IT5HM-200S-BGA(37)	636-1524-6 37		7
300 (300 signals/330 grounds)	Mating Receptacle	IT5D-300S-BGA(39)	636-1525-9 39	56.0	6
		IT5HD-300S-BGA(39)	636-1503-6 39		7
	Mounting Receptacle	IT5M-300S-BGA(37)	636-1504-9 37		6
		IT5HM-300S-BGA(37)	636-1526-1 37		7

Interposer

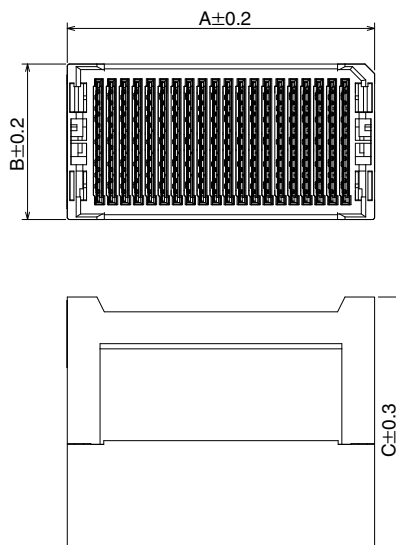

*Unit : mm

Height (mm)	Part No.	HRS No.	A	B	C	Height (mm)	Part No.	HRS No.	A	B	C
14	IT5M1-100P-14H (03)	636-1041-2 03	24.0	21	12.7	28	IT5-100P-28H (03)	636-1051-6 03	24.0	21	26.8
	IT5M1-200P-14H (03)	636-1062-2 03	41.5	23			IT5-200P-28H (03)	636-1042-5 03	41.5		
	IT5M1-300P-14H (03)	636-1064-8 03	59.0				IT5-300P-28H (03)	636-1052-9 03	59.0		
18	IT5-100P-18H (03)	636-1043-8 03	24.0	21	16.8	32	IT5-100P-32H (03)	636-1055-7 03	24.0	21	30.8
	IT5-200P-18H (03)	636-1044-0 03	41.5				IT5-200P-32H (03)	636-1014-0 03	41.5		
	IT5-300P-18H (03)	636-1045-3 03	59.0				IT5-300P-32H (03)	636-1015-2 03	59.0		
22	IT5-100P-22H (03)	636-1048-1 03	24.0	21	20.8	35	IT5-100P-35H (03)	636-1038-8 03	24.0	21	33.8
	IT5-200P-22H (03)	636-1049-4 03	41.5				IT5-200P-35H (03)	636-1017-8 03	41.5		
	IT5-300P-22H (03)	636-1050-3 03	59.0				IT5-300P-35H (03)	636-1016-5 03	59.0		
25	IT5-100P-25H (03)	636-1035-0 03	24.0	21	23.8	38	IT5-100P-38H (03)	636-1056-0 03	24.0	21	36.8
	IT5-200P-25H (03)	636-1036-2 03	41.5				IT5-200P-38H (03)	636-1057-2 03	41.5		
	IT5-300P-25H (03)	636-1037-5 03	59.0				IT5-300P-38H (03)	636-1029-7 03	59.0		

PCB footprint

Mounting Receptacle - IT5(H)M

Mating Receptacle - IT5(H)D

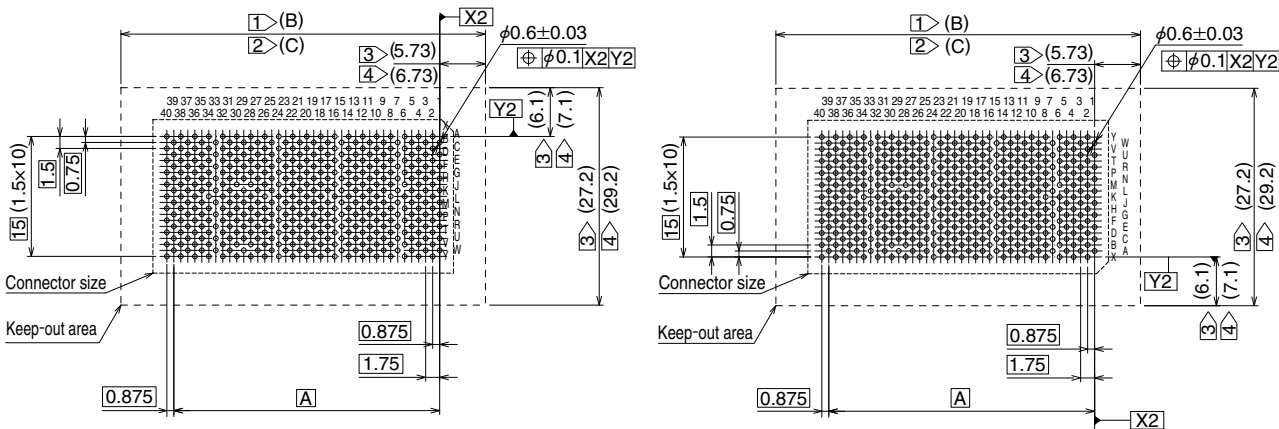

- 1 Minimum clearance for all devices
- 2 Minimum clearance for sensitive devices

Dimension	100	200	300
A	15.75	33.25	50.75
B	28.10	45.60	63.10
C	30.10	47.60	65.10

Spacers

Spacers are required to support the PWB's and protect the BGA solder joints.

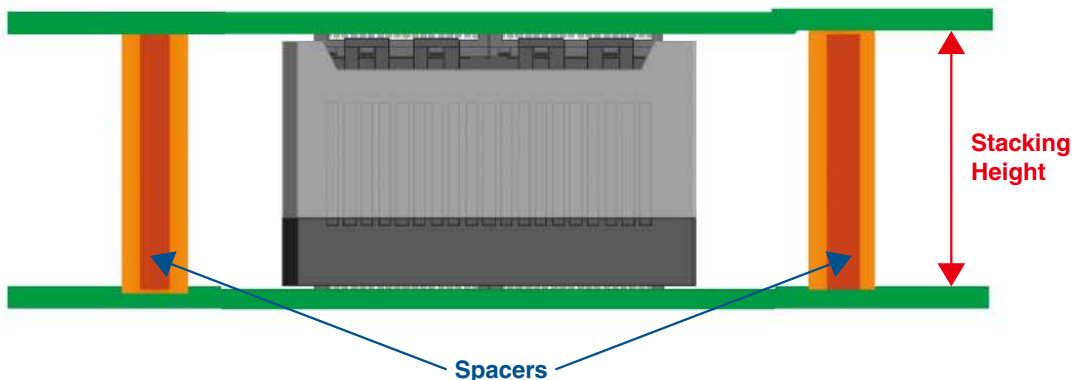

Suggested spacer style is shown below:



Spacer, male-male, M3 thread

The recommended spacer height corresponds to the interposer stacking height as shown in the chart below :

Stacking Height	Recommended Spacer Height	Stacking Height	Recommended Spacer Height
14mm	14+/-0.1mm	28mm	28+/-0.127mm
15mm	15+/-0.1mm	29mm	29+/-0.127mm
16mm	16+/-0.1mm	30mm	30+/-0.127mm
18mm	18+/-0.127mm	32mm	32+/-0.127mm
19mm	19+/-0.127mm	33mm	33+/-0.127mm
20mm	20+/-0.127mm	34mm	34+/-0.127mm
22mm	22+/-0.127mm	35mm	35+/-0.127mm
23mm	23+/-0.127mm	36mm	36+/-0.127mm
24mm	24+/-0.127mm	37mm	37+/-0.127mm
25mm	25+/-0.127mm	38mm	38+/-0.127mm
26mm	26+/-0.127mm	39mm	39+/-0.127mm
27mm	27+/-0.127mm	40mm	40+/-0.127mm

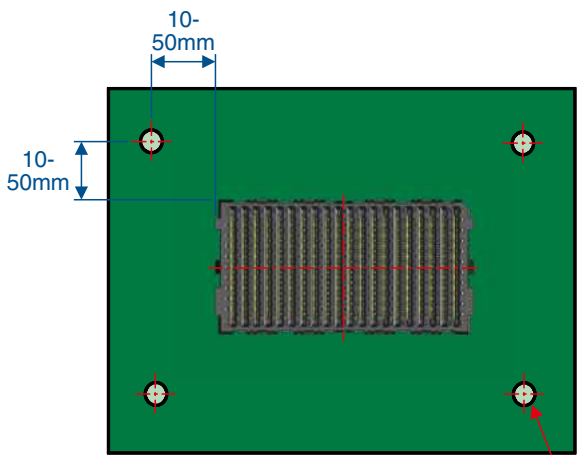

Recommended Spacer Location

$\phi 3.5$
Non plated through hole

Two spacers located diagonally are minimally required. Some applications may require 4 spacers. Spacers should be located 10 – 50 mm from the corners of the receptacles to prevent excessive mechanical loading on the interconnections. If assembly will be subjected to vibration, spacers should be located to prevent resonance, and additional spacers may be required.

Interposer installation

Position interposer directly over mounting receptacle, aligning the polarity chamfers. If positioned properly, the interposer should slide easily onto the mounting receptacle. Place installation cap onto interposer and push straight down to engage the locking latches.

Manual Installation

*Installation caps are available upon request for manual operation

Press firmly on installation cap only, not on wafers or interposer body

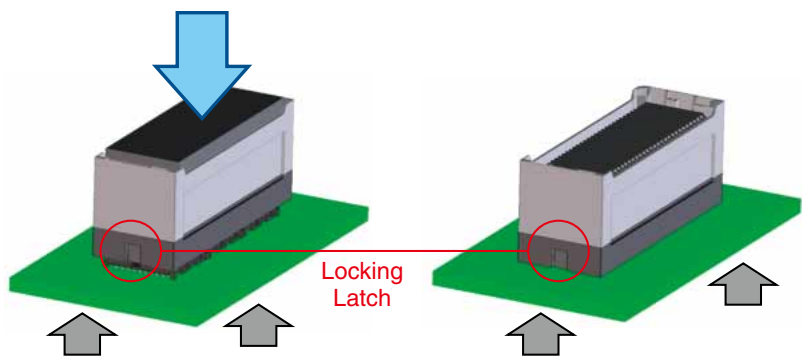
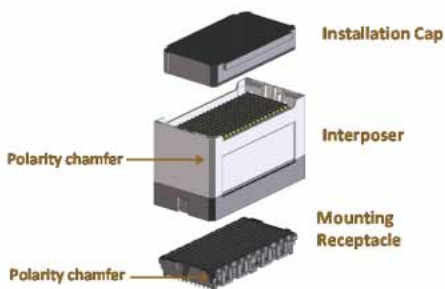

Always support PWB from underside to prevent flexing

■ Daughter card installation

After the interposer is mounted, install spacers onto motherboard. To install mating receptacle, align the spacer holes in the daughter card with the threads on the spacers.

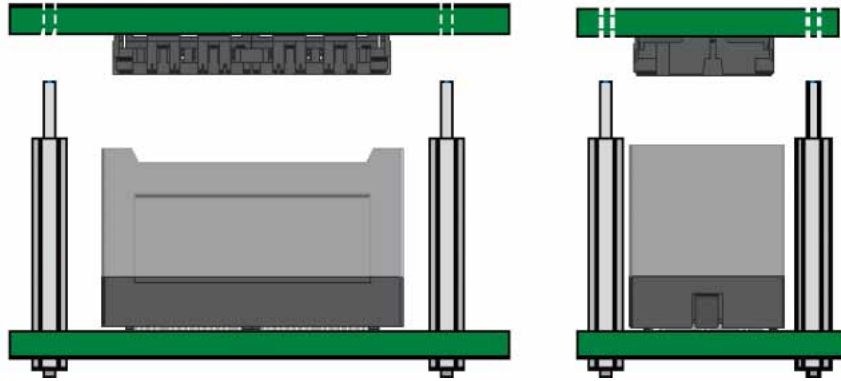

The spacers help align the mating receptacle with the interposer. If positioned correctly, the mating receptacle will slip down into the interposer.

Push directly down on the assembly to lock the mating receptacle in place. Install nuts onto the spacer threads. Tighten nuts to specified torque.

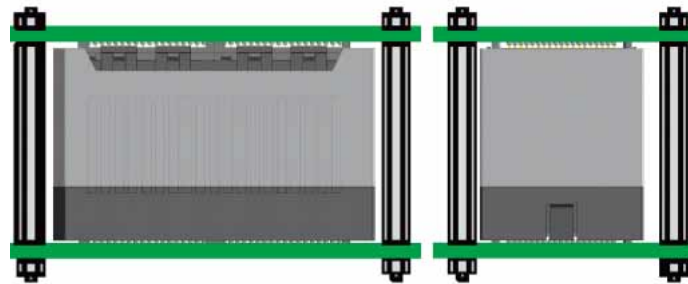

■ Daughter card removal

To remove a daughter card, first remove the nuts from the reinforcing spacers, then lift the daughter card straight off the interposers, as shown right.

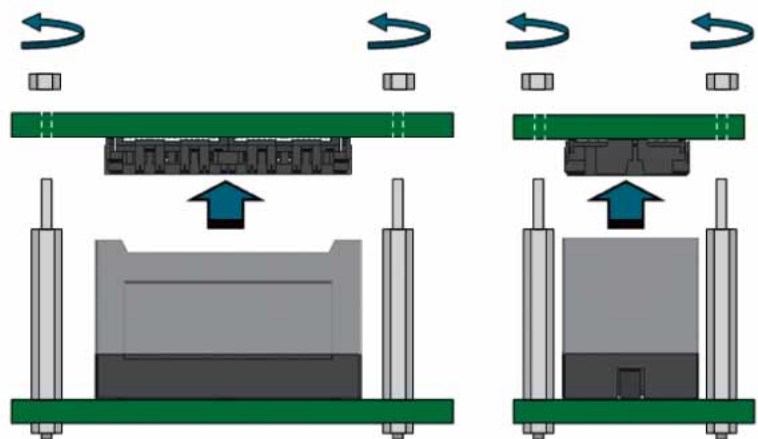

Interposer removal

Interposer Removal by Hand

- 1) Hold the Interposer Assembly on the walls without locking latches

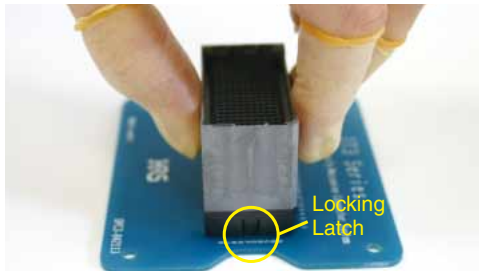

- 2) Gently rotate one side of the Interposer Assembly laterally 10° maximum



Caution: do not rotate more than 10 degrees

- 3) While gently rotating, pull up on other side of the Interposer Assembly

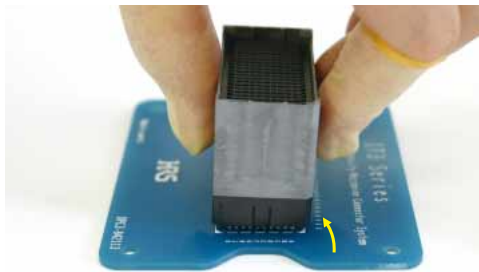

- 4) The Interposer Assembly is removed, and the Mounting Receptacle is ready to accept another Interposer Assembly.

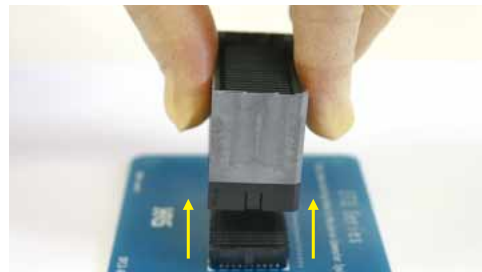

An interposer removal tool is also available. This tool is not an interposer installation cap, so please do not use it to install an interposer. Doing so may damage an interposer.

Interposer Removal with Tool

- 1) Cover the interposer Assembly with the interposer removal tool

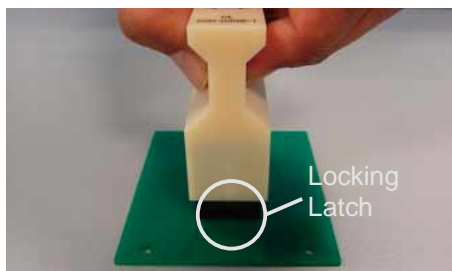

- 2) Gently rotate one side of the Interposer Assembly laterally 10° maximum using the tool

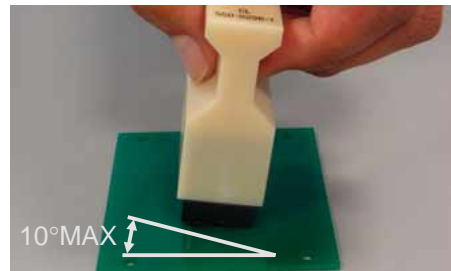

Caution: do not rotate more than 10 degrees

- 3) While gently rotating, pull up on other side of the tool

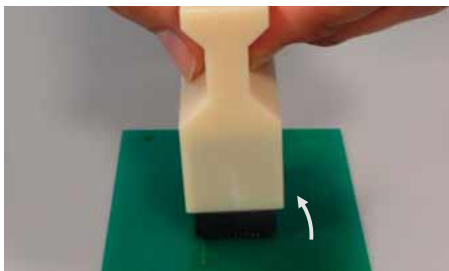

- 4) The Interposer Assembly is removed, as it is inside the tool

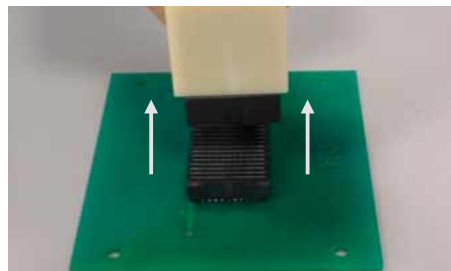

Precaution

Visually inspect the interposer before reinstalling it. Discard if it shows any sign of damage or wear. Do not subject the interposer assembly to more than five removal-reinstallation cycles, even if it appears unaffected. Removal Tools are available upon request for IT5M1-***P-14H(03).

Assembly reflow soldering profile

Parameters	Pb-Free	Comment
Preheat Ramp Rate	2 - 3°C/sec	Other components may limit ramp rate to 2°C/sec
Soak Time	0 - 120 sec	Soak requirements determined by board design, oven capability, and paste activation requirements
Soak Temperature	160 - 215°C	Caution - "oversoaking" may exhaust flux and affect soldering
Peak Reflow Temperature	230 - 250°C	Cooler peak temperatures may require longer TAL's
Time Above Liquidus (TAL)	45 - 120 sec	Shorter TAL's may require higher peak temperatures
Cooling Rate	>6°C/sec	Faster cooling rates produce finer grain structures and smoother joint appearances
Maximum Package Body Temperature (T)	260°C	Open body design allows for low delta T between package and solder joint
Maximum Delta T between Body and PWB at Liquidus	10°C	Standard practice is easy to achieve with open body design
Package Body Exposure Limit at Maximum Temperature	5 sec	Adjust profile if maximum exposure limit is approached or exceeded

Reflow Profile

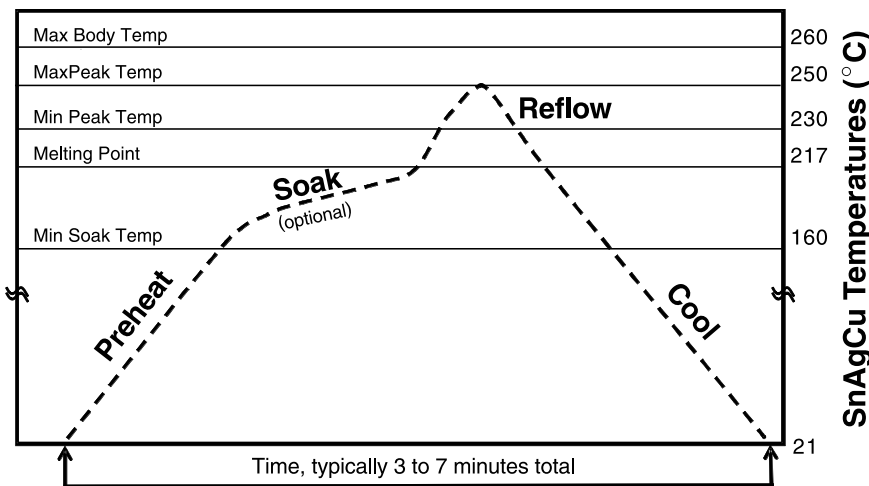

Different solder pastes have different thermal performance characteristics. Consult with paste manufacturer for optimum profile settings. Check thermal exposure limits of PWB laminate if processing with Pb-free solder.

Mating self alignment

*Unit: mm

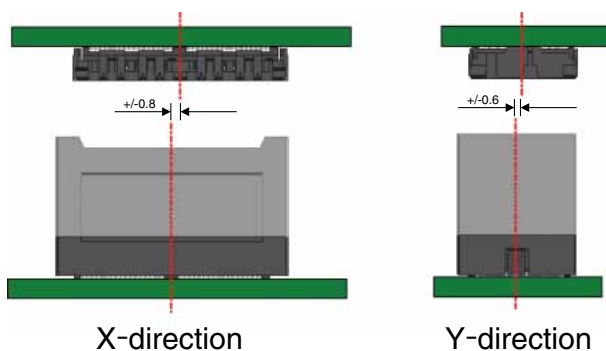

Mating tolerance

Due to its 3-piece design, the IT5 connector system can accept mating tolerances of up to ± 0.3 mm tolerance in the X-axis and up to ± 0.2 mm in the Y-axis.

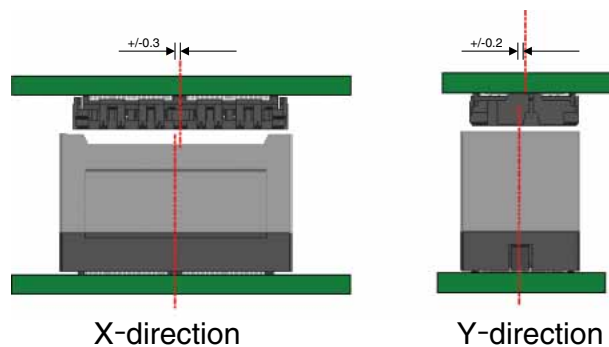

Packaging information

Please order per box with its Minimum Order Quantity (MOQ) of connectors contained. The number for each configuration is shown below.

Receptacles

IT $\frac{5*}{(1)}$ - $\frac{***S}{(2)}$ - BGA(**)

Unit : pcs

(1) \ (2)	100	200	300
(H)M	120	72	48
(H)D	120	72	48

This is also a packaging quantity, therefore please multiply integrally based on this MOQ quantity when you place more.

Ex.) 240pcs of IT5M-300S-BGA(57)
(= 5 of vacuum packed boxes)

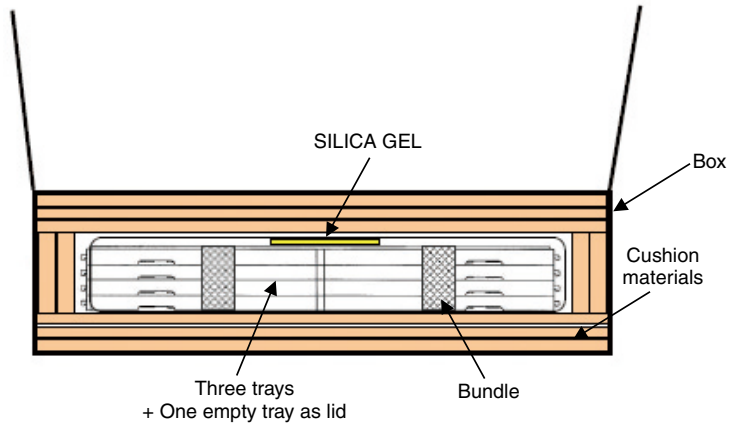

Packaging information

Interposers

IT5* - $\frac{***P}{(3)}$ - $\frac{**H(**)}{(4)}$

Unit : pcs

(4) \ (3)	100	200	300
14	100	80	60
18	100	80	60
22	100	80	60
25	100	80	60
28	50	40	30
32	50	40	30
35	50	40	30
38	50	40	30

This is also a packaging quantity, therefore please multiply integrally based on this MOQ quantity when you place more.

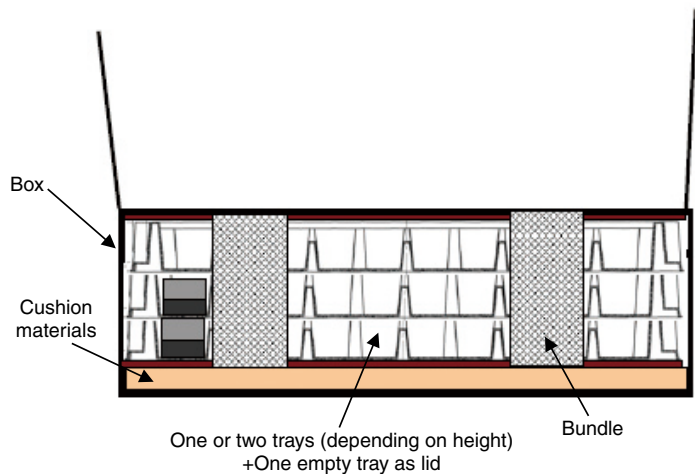

■ Tray information

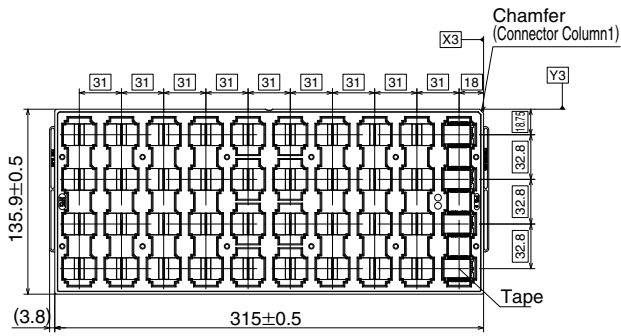

JEDEC Tray for IT5(H)M 100 Position Receptacles

■ Tray information (con't)

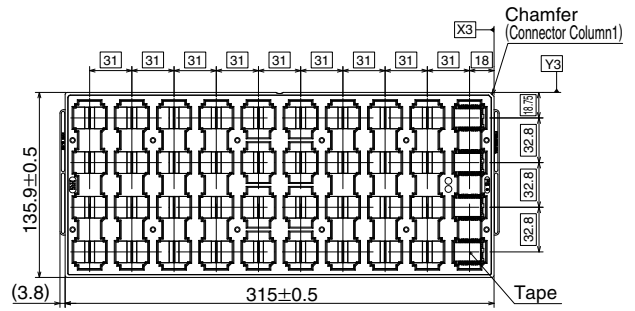

JEDEC Tray for IT5(H)D 100 Position Receptacles

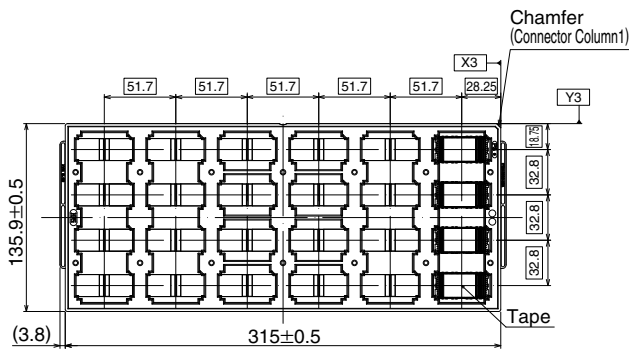

JEDEC Tray for IT5(H)M 200 Position Receptacles

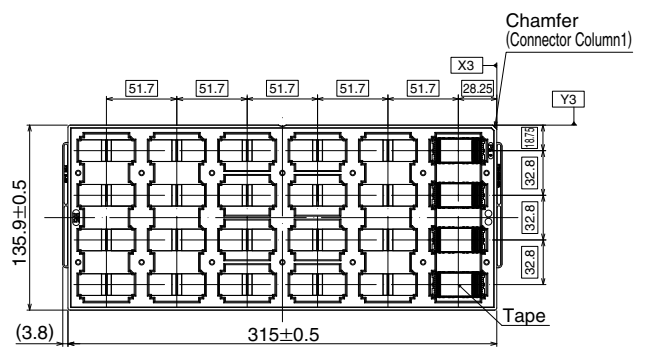

JEDEC Tray for IT5(H)D 200 Position Receptacles

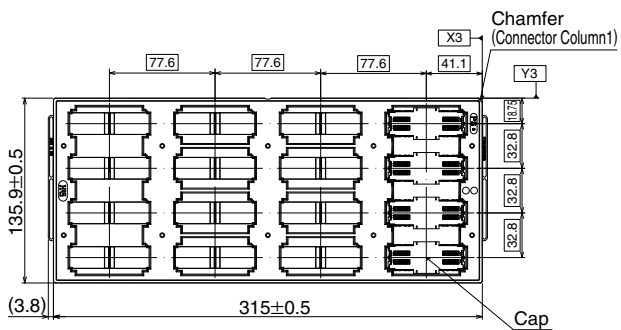

JEDEC Tray for IT5(H)M 300 Position Receptacles

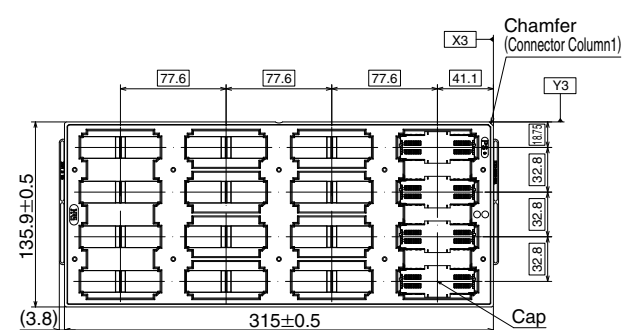

JEDEC Tray for IT5(H)D 300 Position Receptacles

Sep. 1. 2022 Copyright 2022 HIROSE ELECTRIC CO., LTD. All Rights Reserved.



HIROSE ELECTRIC CO.,LTD.

2-6-3,Nakagawa Chuoh,Tsuzuki-Ku,Yokohama-Shi 224-8540,JAPAN

TEL: +81-45-620-3526 Fax: +81-45-591-3726

<http://www.hirose.com>

<http://www.hirose-connectors.com>