

REVISIONS					
REV	ECO	DESCRIPTION	DATE	BY	APPR
A1	-	RELEASE NEW DRAWING	08/MAY/23	VITO	TOMMY

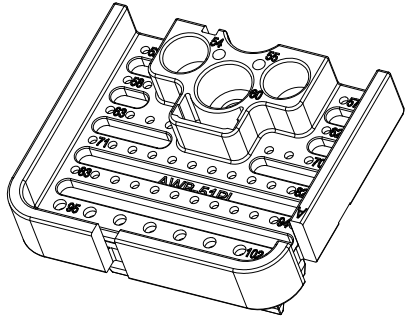
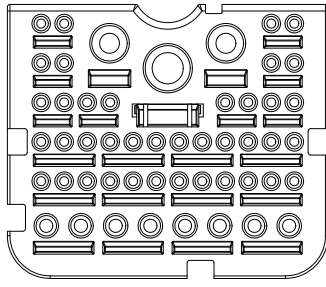
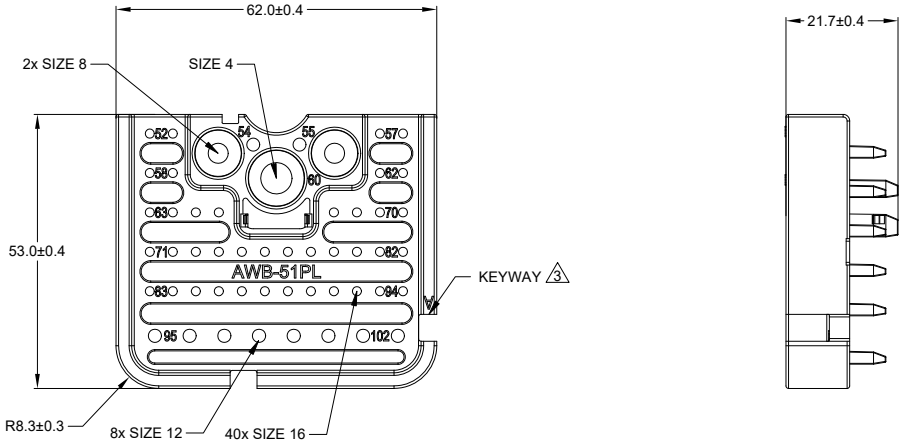

- NOTES: UNLESS OTHERWISE SPECIFIED
1. MATERIAL: THERMOPLASTIC, COLOR: SEE SHEET 2.
 2. RoHS COMPLIANT.
 3. SEE SHEET 2 FOR OTHER KEY ARRANGEMENTS.
 4. THIS WEDGE LOCK MATES WITH: ARB12-102PxR-XXXX RECEPTACLE (x =A,B,C,D,KEYS; XXXX =MODIFICATIONS AND COLORS).
 5. ALL DIMENSIONS ARE FOR REFERENCE USE ONLY.

TITLE: 51 POS, WEDGE LOCK, RECEPTACLE LEFT, PIN,ARB SERIES,KEYED
 DWG NO.: AWB-51PXL
 REV: A1
 SH: 1
 OF: 2

QUANTITY	SEE SHEET 2	DESCRIPTION	ITEM
	PART NUMBER		
MATERIALS LIST			
UNLESS OTHERWISE SPECIFIED 1) All dimensions are in metric(mm). 2) Tolerances are as follows: 1 PL DEC ±0.30 Fractions ±1/64 2 PL DEC ±0.15 3 PL DEC ±0.08 3) Note reference =		SIGNATURES DATE DRAWN: VITOLJ 08/MAY/23 CHECKED: ORIONLI 08/MAY/23 ENGINEER: APPROVAL: TOMMYXIE 10/MAY/23	<div style="text-align: center;"> <h1>Amphenol</h1> <p>Sine Systems - www.amphenol-sine.com 44724 Morley Drive Clinton Township, MI 48036</p> </div>
MATERIAL SPECIFICATIONS: WEIGHT: 24.5g		CUSTOMER: THIS DRAWING IS SUPPLIED FOR INFORMATION ONLY. DESIGN FEATURES, SPECIFICATIONS AND PERFORMANCE DATA SHOWN HEREON ARE THE PROPERTY OF THE AMPHENOL CORPORATION. NO RIGHTS OF REPRODUCTION ARE IMPLIED. ALL DIMENSIONS ARE SUBJECT TO NORMAL MANUFACTURING VARIATIONS.	51 POS, WEDGE LOCK, RECEPTACLE, LEFT, PIN,ARB SERIES,KEYED
PROCESS SPECIFICATIONS:		SIZE TYPE DWG NO. B C- AWB-51PxL	REVISION A1
NEXT ASSY:		SCALE: NONE	SHEET 1 OF 2

REVISIONS					
REV	ECO	DESCRIPTION	DATE	BY	APPR
A1	-	RELEASE NEW DRAWING	08/MAY/23	VITO	TOMMY

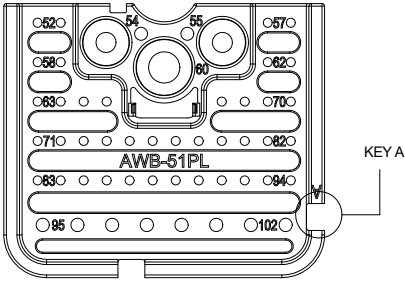

PART NUMBER	COLOR	REF
AWB-51PAL	GREY	WB-51PAR

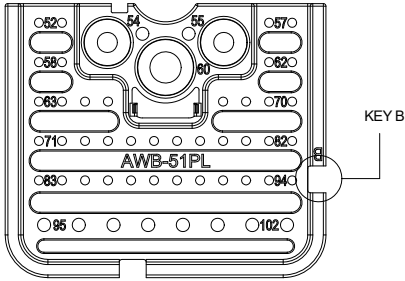

PART NUMBER	COLOR	REF
AWB-51PBL	BLACK	WB-51PBR

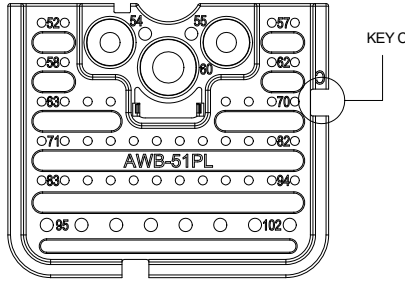

PART NUMBER	COLOR	REF
AWB-51PCL	GREEN	WB-51PCR

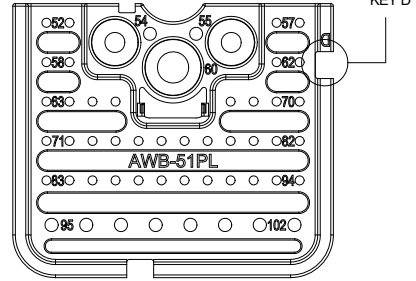

PART NUMBER	COLOR	REF
AWB-51PDL	BROWN	WB-51PDR

QUANTITY	AWB-51PxL	DESCRIPTION	ITEM
	PART NUMBER		

MATERIALS LIST		
SIGNATURES	DATE	
DRAWN: VITOLJ	08/OCT/22	<h1 style="text-align: center;">Amphenol</h1> <p style="text-align: center;">Sine Systems - www.amphenol-sine.com 44724 Morley Drive Clinton Township, MI 48036</p> <p style="text-align: center;">51 POS, WEDGE LOCK, RECEPTACLE, LEFT, PIN,ARB SERIES,KEYED</p>
CHECKED: ORIONLI	08/OCT/22	
APPROVAL: TOMMY XIE	10/MAY/23	
CUSTOMER:		

MATERIAL SPECIFICATIONS:	<small>UNLESS OTHERWISE SPECIFIED</small> 1) All dimensions are in metric(mm). 2) Tolerances are as follows: 1 PL DEC ±0.30 Fractions ±1/64 2 PL DEC ±0.15 Angles ±1° 3 PL DEC ±0.08 3) Note reference =
WEIGHT: 24.5g	
PROCESS SPECIFICATIONS:	

NEXT ASSY:	<small>THIS DRAWING IS SUPPLIED FOR INFORMATION ONLY. DESIGN FEATURES, SPECIFICATIONS AND PERFORMANCE DATA SHOWN HEREON ARE THE PROPERTY OF THE AMPHENOL CORPORATION. NO RIGHTS OF REPRODUCTION ARE IMPLIED. ALL DIMENSIONS ARE SUBJECT TO NORMAL MANUFACTURING VARIATIONS.</small>
------------	-------------------------------------------------------------------------------------------------------------------------------------------------------------------------------------------------------------------------------------------------------------------------------------

SIZE	TYPE	DWG NO:	REVISION
B	C-		A1
SCALE: NONE			SHEET 2 OF 2

TITLE: 51 POS, WEDGE LOCK, RECEPTACLE LEFT, PIN,ARB SERIES,KEYED
 DWG NO: AWB-51PxL
 REV: A1
 SH: 2
 OF: 2