

SECTION A-A

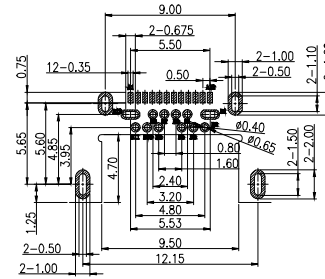

RECOMMENDED P.C.B LAYOUT(Both sides are sample)
Tolerance:±0.05,Thickness=0.60mm

- NOTES:
 1. MATERIAL: COPPER ALLOY
 2. FINISH: G/F
 3. ELECTRICAL :
 3-1. CONTACT CURRENT RATING :
 5A(VBUS PIN 1.5A/PIN),
 5A(GND PIN 1.25A/PIN MAX),0.25A/PIN(OTHER PIN).
 3-2. INSULATION RESISTANCE :
 100 MEGAOHMS MIN. AT 250VDC.
 3-3. DIELECTRIC WITHSTANDING VOLTAGE :
 100VAC MIN.
 3-4. LOW LEVEL CONTACT RESISTANCE :
 INITIAL 40mΩ MAX.
 AFTER 50mΩ MAX.
 3-5. Voltage Rating: 20V Max.
 4. MECHANICAL CHARACTERISTICS :
 4-1. MATING FORCE: 5~20N.
 4-2. UNMATING FORCE: 8~20N(INITIAL),6~20N(AFTER 10000 CYCLES);
 4-3. DURABILITY : 10,000 MATING CYCLES.
 4-4. OPERATING TEMPERATURE : -40°C TO +80°C
 4-5. Salt Spray Test: 48H Min.(No oxidation or rust).

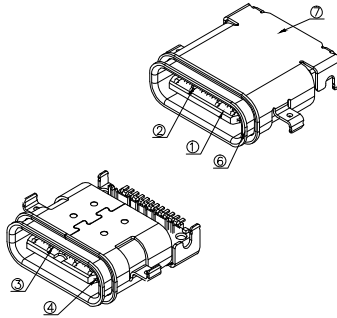
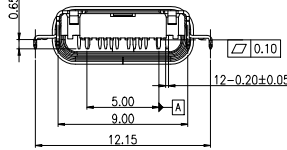
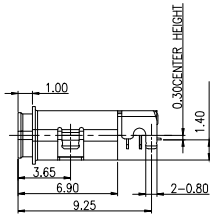
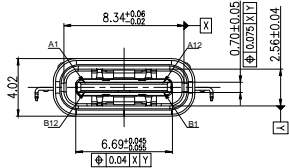

PIN NUMBER	SIGNAL NAME	PIN NUMBER	SIGNAL NAME
A1	GND	B12	GND
A2	SSTXp1	B11	SSRXp1
A3	SSTXn1	B10	SSRXn1
A4	VBUS	B9	VBUS
A5	CC1	B8	SBU2
A6	Dp1	B7	Dn2
A7	Dn1	B6	Dp2
A8	SBU1	B5	CC2
A9	VBUS	B4	VBUS
A10	SSRXn2	B3	SSTXn2
A11	SSRXp2	B2	SSTXp2
A12	GND	B1	GND

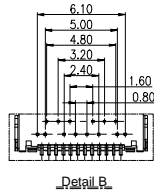
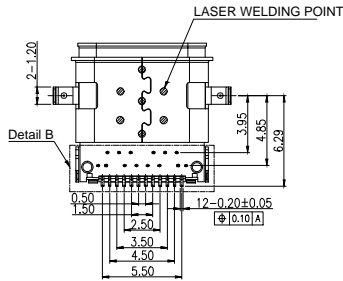

Detail B

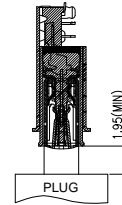
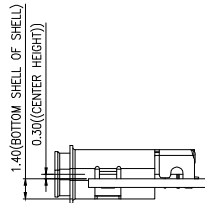

NO.	PART NAME	QTY	MATERIAL	DESCRIPTION	REMARK
⑧	GLUE WATER	1	EPOXY	BLACK	
⑦	Shell-2	1	Stainless steel	NI PLATING;	T=0.20mm
⑥	Shell-1	1	Stainless steel	NI PLATING;	T=0.20mm
⑤	GND PLATE	1	Stainless steel	NI PLATING;	T=0.10mm
④	MID PLATE	1	Stainless steel		T=0.15mm
③	Terminal-B	12	Copper Alloy	G/F	T=0.12mm
②	Terminal-A	12	Copper Alloy	G/F	T=0.12mm
①	Housing	1	HIGH TEMP	Black	

RoHS compliant
Unit: mm

Scale	Free
TOLERANCE	
X.X	±0.30
X.XX	±0.20
X.XXX	±0.10
DIM	TOL
X°	±2°

①	Drawn	08.06.2022	Luca
Id.	Modification	Date	Name



Date	Name	Description:
08.06.2022	Luca	USB Connector
08.06.2022	Luca	USB3.2 GEN1 TYPE C / FEMALE / IPX7
		ASSMANN WSW-No.
		A-USBC-32F1-EA-GRR04
		Drawing-No.
		ASS 9294 CO
		rev00
		Customer-No.
		Sheet 1/3

Recommended Sealing Method

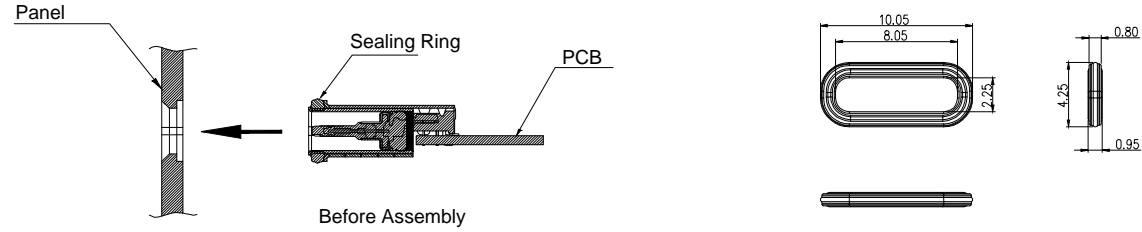

Recommended Specification of Sealing
Material: silicone rubber

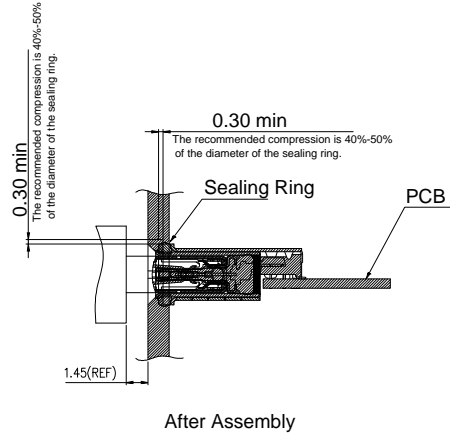

RoHS compliant
Unit: mm

G	Scale	Free					Date	Name	Description: USB Connector	
	TOLERANCE					Drawn	08.06.2022	Luca	USB3.2 GEN1 TYPE C / FEMALE / IPX7	
	X.X	±0.30				Approved	08.06.2022	Luca	ASSMANN WSW-No.	
	X.XX	±0.20							A-USBC-32F1-EA-GRR04	
H	X.XXX	±0.10							Drawing-No.	
	DIM	TOL							ASS 9294 CO	rev00
	X°	±2°							Customer-No.	Sheet 2/3
			①	Drawn	08.06.2022	Luca				
		Id.	Modification	Date	Name					

1

2

3

4

5

6

7

A

NOTES
 1.NUMBER OF CONNECTORS: 700PCS/REEL
 2.QUANTITY: 7000PCS/CARTON

B

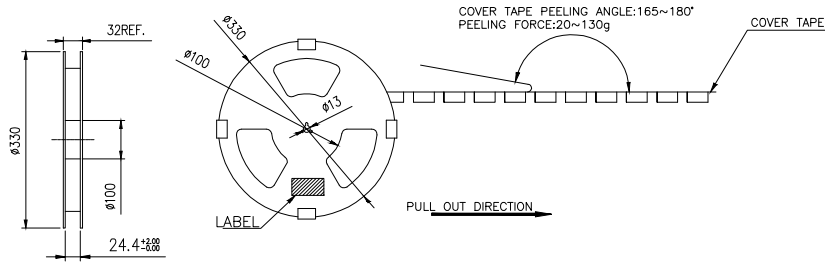

C

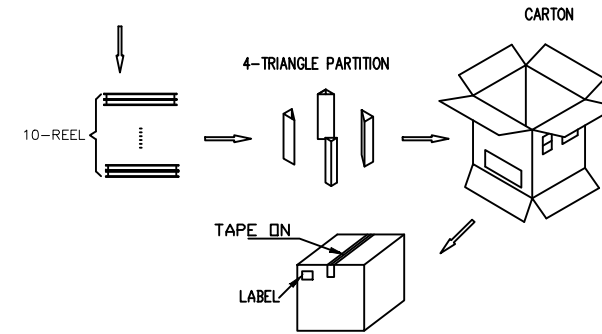

D

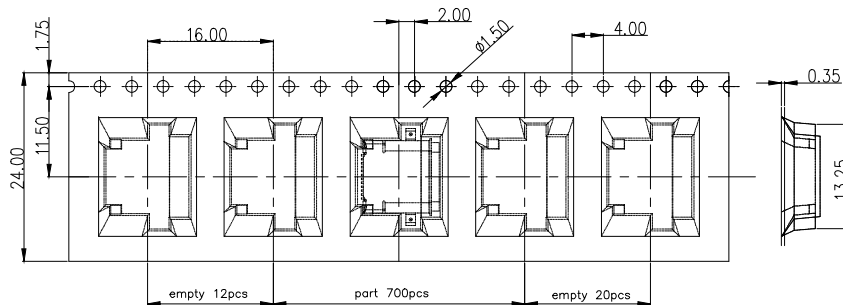

E

PACKAGE OF SEALING RING

5000	6	30000
PCS/ BAG	BAG/ CASE	PCS/CASE

F

G

RoHS compliant
 Unit: mm

Scale	Free
TOLERANCE	
X.X	±0.30
X.XX	±0.20
X.XXX	±0.10
DIM	TOL
X°	±2°

					Date	Name	Description: USB Connector
				Drawn	08.06.2022	Luca	USB3.2 GEN1 TYPE C / FEMALE / IPX7
				Approved	08.06.2022	Luca	ASSMANN WSW-No.
							A-USBC-32F1-EA-GRR04

H



Drawing-No.	ASS 9294 CO	rev00
Customer-No.		Sheet 3/3

①	Drawn	08.06.2022	Luca
Id.	Modification	Date	Name

1

2

3

4

5

6

7