



**SPECIFICATION SHEET**

<b>SPECIFICATION SHEET NO.</b>	R0301- BDAMO000000S00	
<b>DATE</b>	March. 01, 2024	
<b>REVISION</b>	A0	Updated With Most Recent Data - Official First Release
<b>DESCRIPTION AND MAIN PARAMETRICS</b>	<p>Automotive PLCC-4 TOP LED SMD 3528 0.2w Orange Color  L3.50*W2.80*H1.80mm, Colorless &amp; Clear Lens Transparency,  2.4mm Dia. Viewing Angle 120°, Lens Round with Flat Top  Forward Voltage (VF) 1.9~2.65V  Dominant Wavelength Rank (DWL) 600~612nm  Luminous Intensity Rank (IV) 1890~4580mcd  Operating Temp. Range -40°C ~+105°C  Package in Tape/Reel, REACH/RoHS/RoHS III Compliant</p>	
<b>CUSTOMER</b>		
<b>CUSTOMER PART NO.</b>		
<b>CROSS REF. PART NO.</b>		
<b>ORIGINAL MFG/PART NO.</b>	Oriental Technology/ BDA-MO-000000	
<b>PART CODE</b>	BDAMO000000S00	

<b>VENDOR APPROVE</b>			
Issued/Checked/Approved			
DATE: March. 01, 2024			

<b>CUSTOMER APPROVE</b>	
DATE:	

## AUTO. PLCC-4 TOP LED SMD 3528 BDAM SERIES ORANGE

### MAIN FEATURE

- Orange Color PLCC-4 Package
- Luminous Intensity@50mA: 1890~4580mcd
- Emitting Material: InGaAlP Chip
- View Angle at 50% Iv of 120°
- Corrosion Robustness: Excellent Corrosion Robustness
- Suitable for SMT process
- Cross Competitors Parts
- REACH/RoHS/RoHS III Compliant
- Moisture Sensitivity Level (MSL) 2A (4 weeks)



### APPLICATION

- Auto Signaling
- Auto Lighting Interior and Exterior
- Signal and Symbol Luminary

### ELECTRICAL CHARACTERISTICS

- See Page 6 ~Page 7

### HOW TO ORDER

- Please indicate part code OR custom parameters code and send us your RFQ by E-mail.

**AUTO. PLCC-4 TOP LED SMD 3528 BDAM SERIES ORANGE**

**PART CODE GUIDE**

**RFQ**

[Request For Quotation](#)

CODE	NAME	KEY SPECIFICATION OPTION
BDA	Product Series Code	Automotive SMD LED PLCC-4 with lens 120° Package 3528, 0.2w Lens Round with Flat Top, Dimension L3.50*W2.80*H1.80mm
O	Color Code	O: Orange Color
00	Forward Voltage Rank (VF)	Custom letter A~Z, a-z or digits (0-9) 00: 1.9V ~2.65V; V1: 1.9V ~2.05V; V2: 2.05V ~2.2V; V3: 2.2V ~2.35V; V4: 2.35V ~2.5V; V5: 2.5V~2.65V
00	Dominant Wavelength Rank (DWL)	Custom letter A~Z, a-z or digits (0-9) 00: 600nm~ 612nm; WB: 600nm~ 604nm; WC: 604nm~ 608nm WD: 608nm~ 612nm
00	Luminous Intensity Rank (IV)	Custom letter A~Z, a-z or digits (0-9) 00: 1890mcd ~4580mcd; FC: 1890mcd ~2290mcd; FD: 2290mcd ~2880mcd; FE: 2880mcd ~3600mcd; FF: 3600mcd ~4580mcd
S00	Internal Control Code	Custom letter A~Z, a-z or digits (0-9)

**AUTO. PLCC-4 TOP LED SMD 3528 BDAM SERIES ORANGE**

**DIMENSION** – (Unit: mm, Tolerance: +/-0.1mm)

Image For Reference



**Size Code 3528**

Lens Round with Flat Top  
L3.50\*W2.80\*H1.80mm  
Appro. Weight: 30mg each

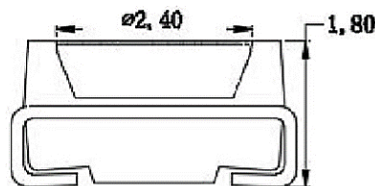
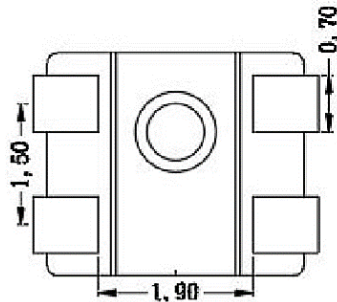
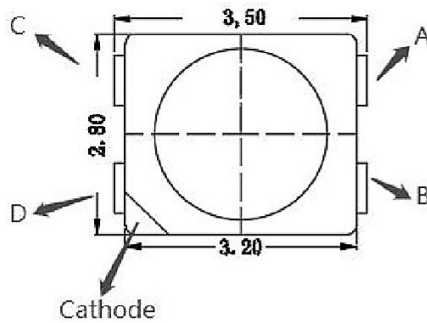

**AUTO. PLCC-4 TOP LED SMD 3528 BDAM SERIES ORANGE**

**Circuit**

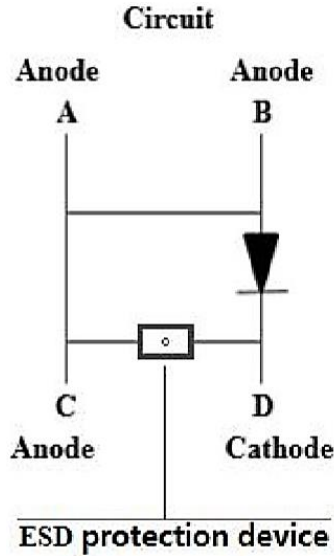

**Recommend Pad Layout** (Unit: mm, Tolerance: +/-0.1mm)

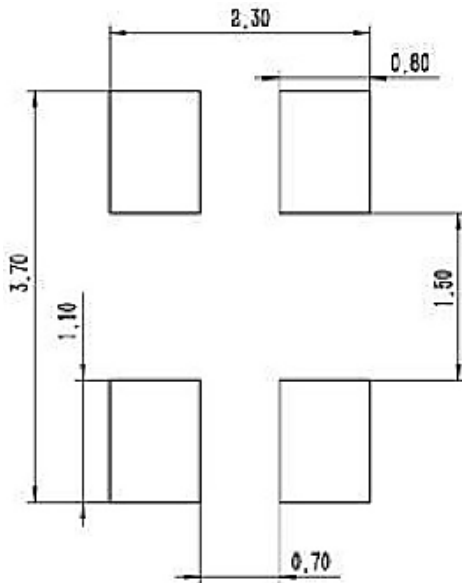

**Recommended Solder pad**

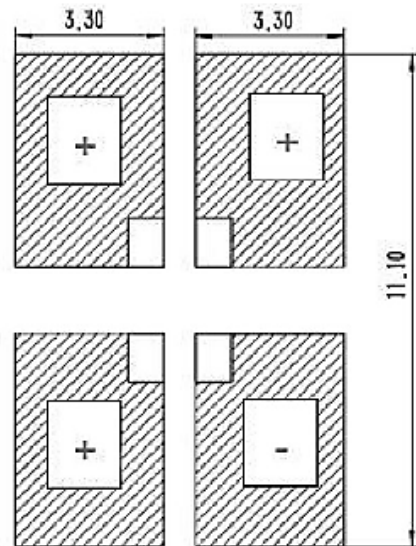

**Recommended Stencil opening**

**AUTO. PLCC-4 TOP LED SMD 3528 BDAM SERIES ORANGE**
**MAXIMUM RATINGS** Ts=25°C, RH60%

PARAMETERS	SYMBOL	VALUES	UNIT
Operating Temperature	Top	-40~+105	°C
Storage Temperature	Tstg	-40~+105	°C
Junction Temperature	Tj	125	°C
Forward Current (Ts=25°C)	IF	70	mA
Surge Current (t≤10μs; D=0.005; Ts=25°C)	IFs	100	mA
Reverse Voltage (Ts=25°C)	VR	5	V
Electrostatic Discharge (acc.to ANSI/ESDA/JEDEC JS-001-2017)	VESD	≥2	kV

**OPTICAL & ELECTRICAL CHARACTERISTICS** IF=50mA, Ts=25°C, RH60%

PARAMETERS	SYMBOL	VALUES			UNIT
		MIN.	TYP.	MAX.	
Peak Wavelength	$\lambda_{peak}$	-	610	-	nm
Dominant wavelength	$\lambda_{dom}$	600	-	612	nm
Luminous Intensity @50mA	IV	1890	-	4580	mcd
Spectral bandwidth at 50% IV	$\Delta\lambda$	-	18	-	nm
Viewing Angle	2θ 1/2	-	120	-	Deg
Forward Voltage	VF	1.9	2.3	2.65	V
Reverse Current	IR (VR=5V)	-	0.2	10	μA
Thermal Resistance junction/solder point	Rth(j-sp)real	-	100	115	K/W
Electrical Thermal Resistance junction/solder point with efficiency η=34%	Rth(j-sp)elec	-	66	77	K/W

**AUTO. PLCC-4 TOP LED SMD 3528 BDAM SERIES ORANGE**
**ELECTRICAL CHARACTERISTICS** IF=50mA, Ts=25°C, RH60%, Tol. :±0.05V

Part Code	Forward Voltage - VF (V)	Dominant Wavelength- DWL (nm)	Luminous Intensity- IV (mcd)
BDAMO000000S00	1.9~2.65	600~612	1890~4580

**BIN CODE LIST**

PARAMETERS	SYMBOL	VALUES	TOLERANCE	UNIT
Forward Voltage Rank (VF) @IF=50mA, Ts=25°C, RH60%	00	1.9~2.65	±0.05	V
	V1	1.9~2.05		
	V2	2.05~2.2		
	V3	2.2~2.35		
	V4	2.35~2.5		
	V5	2.5~2.65		
Dominant Wavelength Rank- DWL @IF=50mA, Ts=25°C, RH60%	00	600~612	±1.5	nm
	WB	612~604		
	WC	604~608		
	WD	608~612		
Luminous Intensity Rank- IV @IF=50mA, Ts=25°C, RH60%	00	1890~4580	±5.0%	mcd
	FC	1890~2290		
	FD	2290~2880		
	FE	2880~3600		
	FF	3600~4580		

**AUTO. PLCC-4 TOP LED SMD 3528 BDAM SERIES ORANGE**

**OPTICAL & ELECTRICAL CHARACTERISTICS CURVES** -IF=50mA, Ts=25°C, RH60%

Figure 1. Relative Spectral Emission,  $I_{rel}=f(\lambda)$ ,  $\Phi_{rel} = f(\lambda)$ ; Tj = 25°C; IF= 50mA

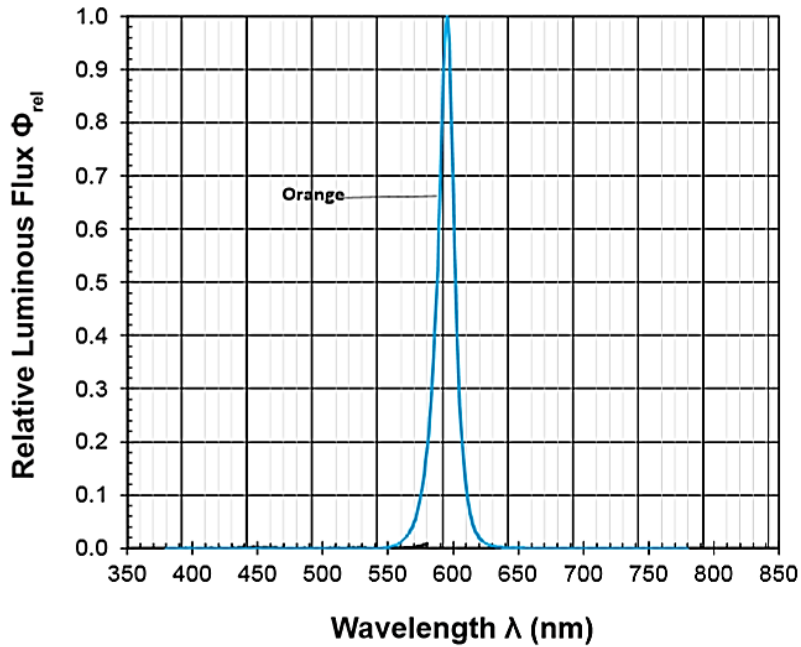
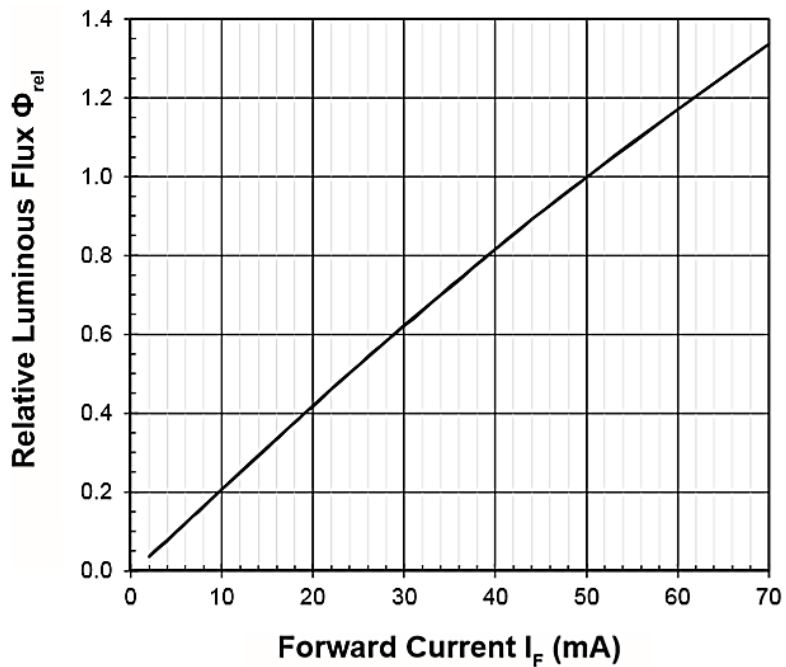

Figure 2. Forward Current Vs. Relative Intensity,  $\Phi_V/\Phi_V(50mA)= f(I_F)$





**AUTO. PLCC-4 TOP LED SMD 3528 BDAM SERIES ORANGE**

**OPTICAL & ELECTRICAL CHARACTERISTICS CURVES** - $I_F=50\text{mA}$ ,  $T_s=25^\circ\text{C}$ ,  $\text{RH}60\%$

Figure 3. Forward Voltage Vs. Forward Current,  $I_F = f(V_F)$

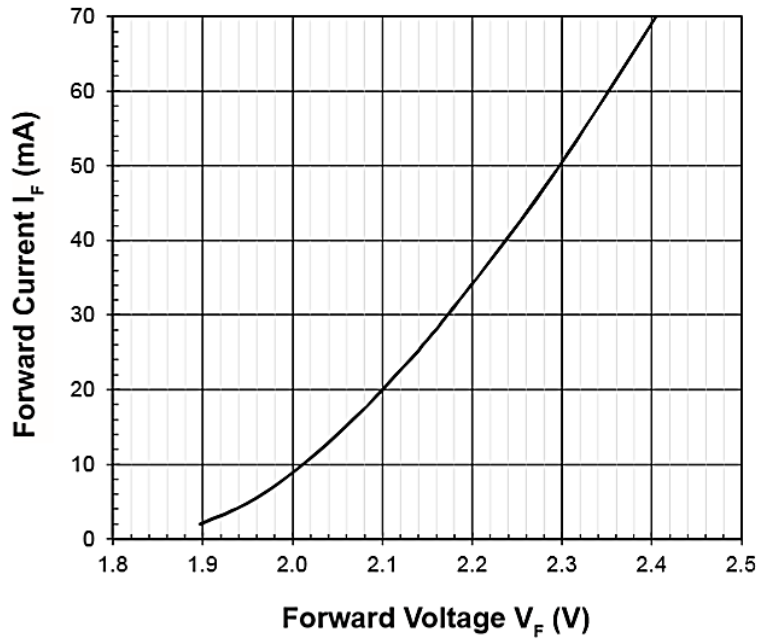
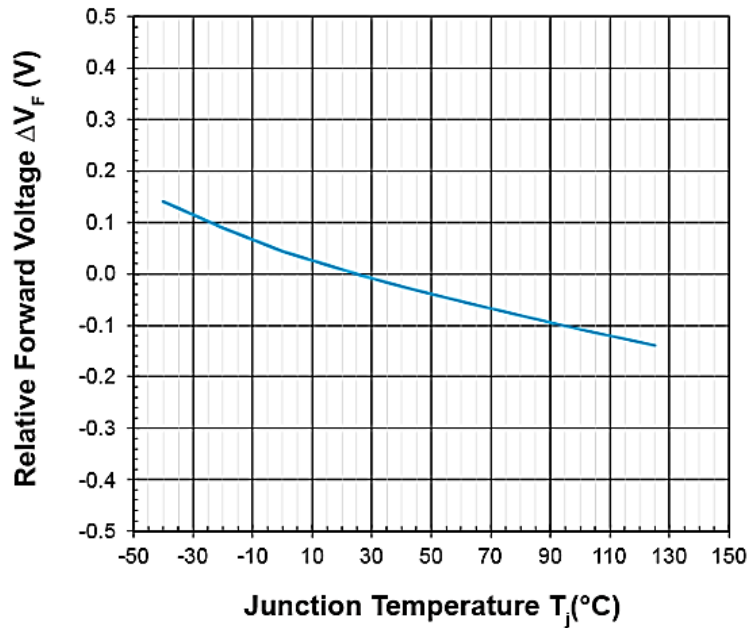

Figure 4. Junction Temperature Vs. Relative Forward Voltage



**AUTO. PLCC-4 TOP LED SMD 3528 BDAM SERIES ORANGE**

**OPTICAL & ELECTRICAL CHARACTERISTICS CURVES** -IF=50mA, Ts=25°C, RH60%

Figure 5. Junction Temperature Vs. Relative Luminous Intensity

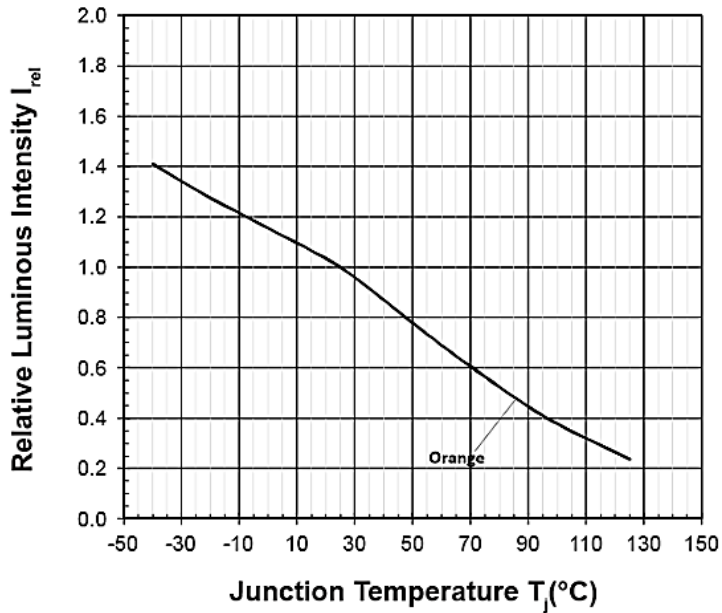
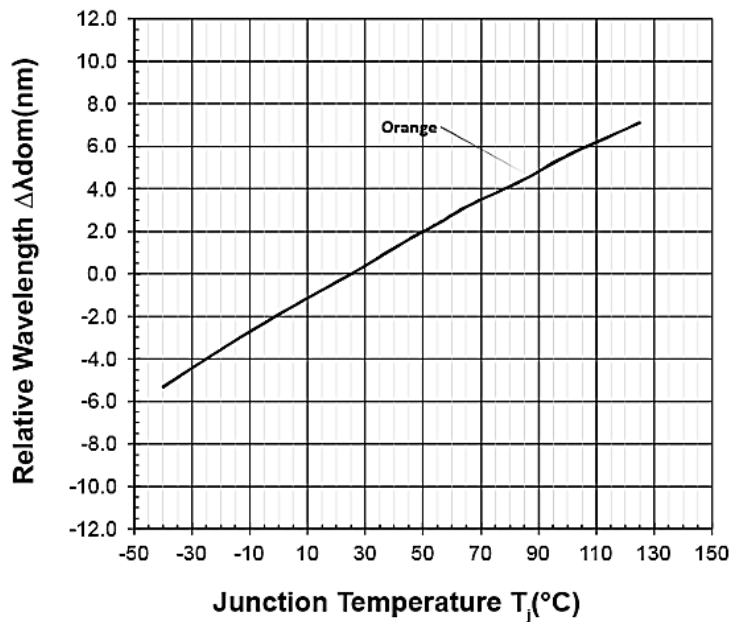

Figure 6. Junction Temperature Vs Relative Wavelength,  
 $\Delta\lambda_{dom} = \lambda_{dom} - \lambda_{dom}(25^\circ\text{C}) = f(T_j)$ ; IF =50mA



**AUTO. PLCC-4 TOP LED SMD 3528 BDAM SERIES ORANGE**

**OPTICAL & ELECTRICAL CHARACTERISTICS CURVES** -IF=50mA, Ts=25°C, RH60%

Figure 7 Maximum Current Vs Temperature,  $I_F = f(T)$

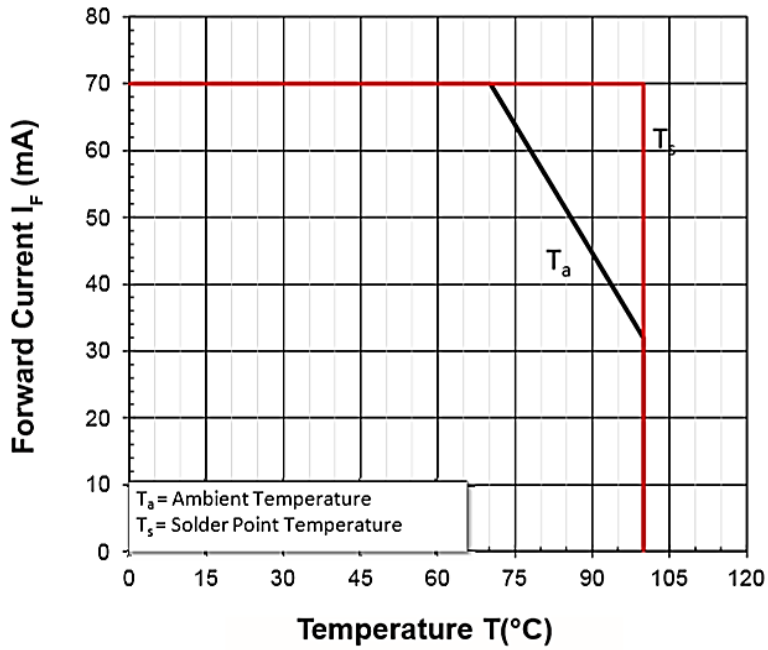
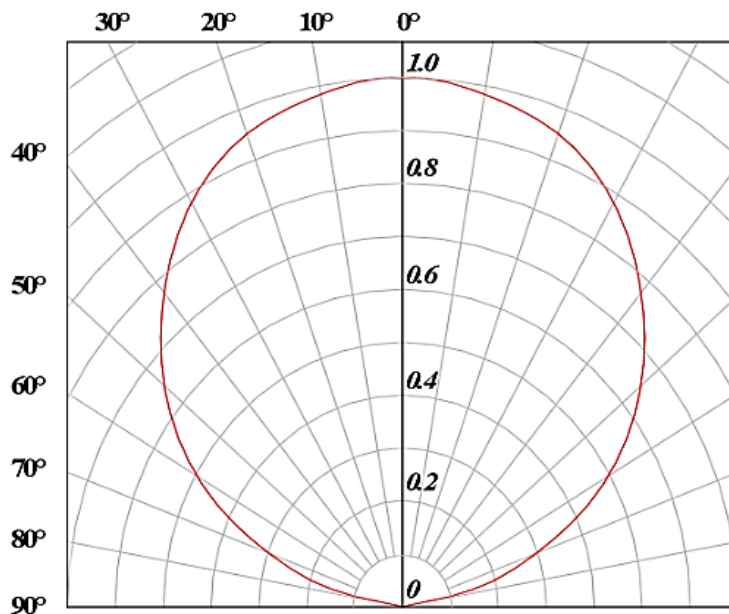

Figure 8. Radiation Diagram,  $I_{rel} = f(\Phi)$



**AUTO. PLCC-4 TOP LED SMD 3528 BDAM SERIES ORANGE**

**OPTICAL & ELECTRICAL CHARACTERISTICS CURVES** -IF=50mA, Ts=25°C, RH60%

Figure 9 Allowable Forward Current Vs Duty Ratio, ( Ts = 55°C; tp ≤ 100μs)

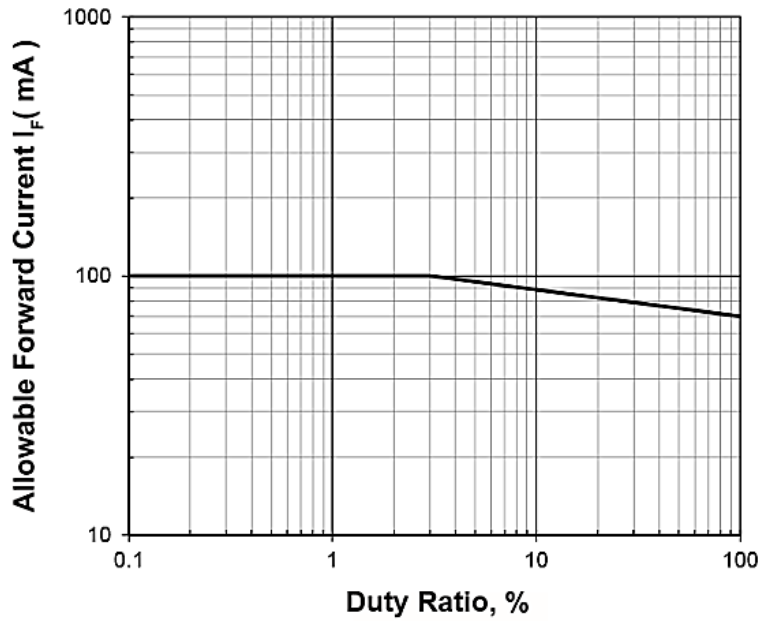

**AUTO. PLCC-4 TOP LED SMD 3528 BDAM SERIES ORANGE**

**REFLOW SOLDERING CHARACTERISTICS**

Product complies to MSL Level 2a acc. To JEDEC J-STD-020 D.01

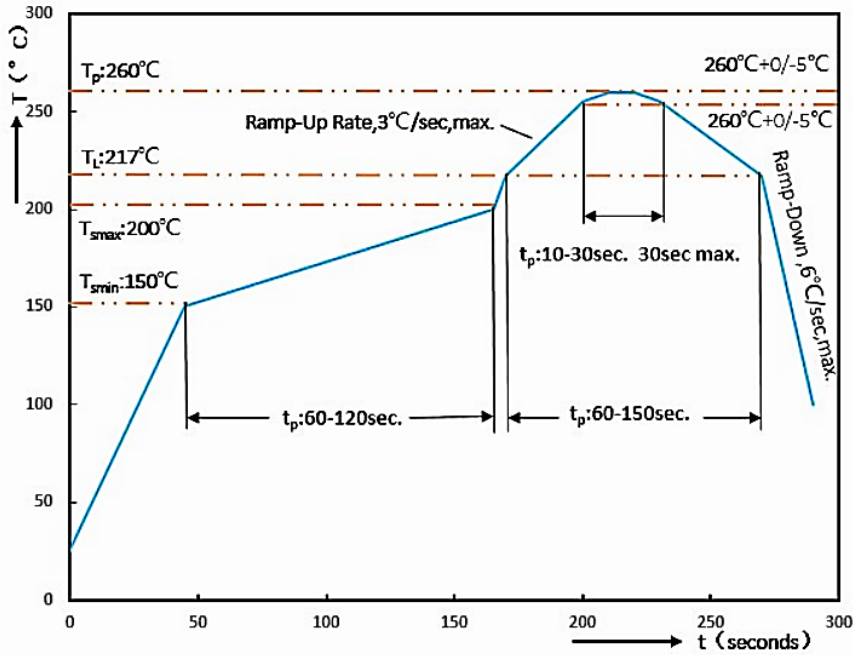

PROFILE FEATURE		PB-FREE ASSEMBLY
Average Ramp-up Rate (Ts Max to Tp)		3°C/second Max
Preheat	Temperature Min (Ts Min.)	150°C
	Temperature Max (Ts Max.)	200°C
	Time (ts Min. to ts Max.)	60 ~ 120 seconds
Time maintained above	Temperature (Tl)	217°C
	Time (tl)	60 ~ 150 seconds
Peak/Classification Temperature (Tp)		260 °C
Time within 5°C of actual Peak Temperature (tp)		30 seconds Max
Ramp-down rate		6 °C /Second Max.
Time 25 °C to Peak Temperature		8 minutes Max.
Suggest reflow times		3 Times Max.

**AUTO. PLCC-4 TOP LED SMD 3528 BDAM SERIES ORANGE**

**TAPE/REEL, 2000pcs/Reel (Unit: mm)**

- All Devices are packed in accordance with EIA standard RS-481-A
- Cumulative Tolerance : Cumulative Tolerance/10 pitches to be  $\pm 0.2\text{mm}$
- Adhesion Strength of Cover Tape Adhesion strength to be 0.1-0.7N when the cover tape is turned off from the carrier tape at the angle of  $10^\circ$  to the carrier tape.
- Moisture Resistant Package

Tape

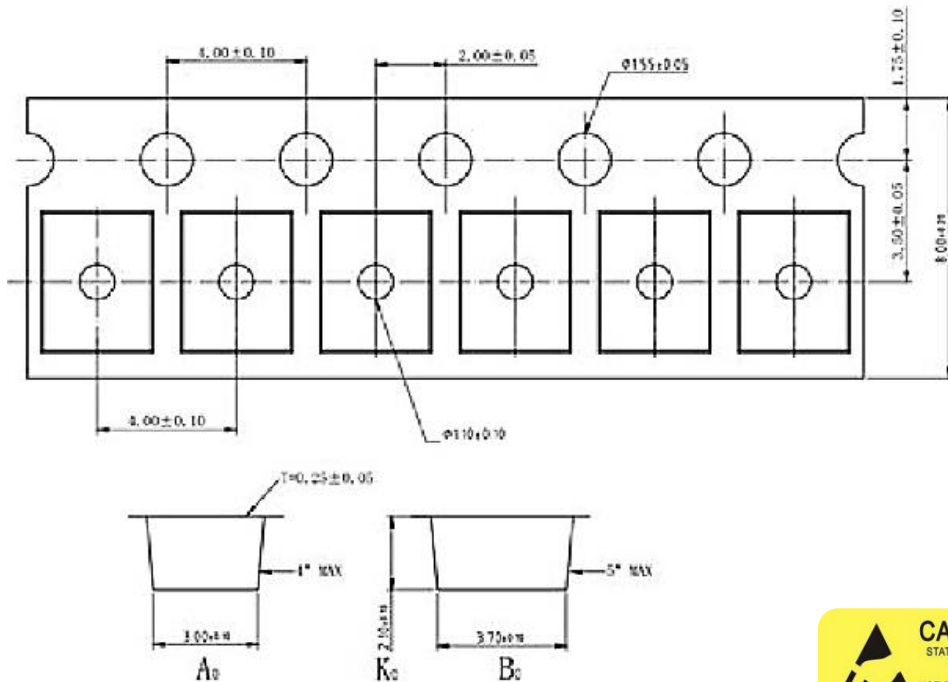

Reel

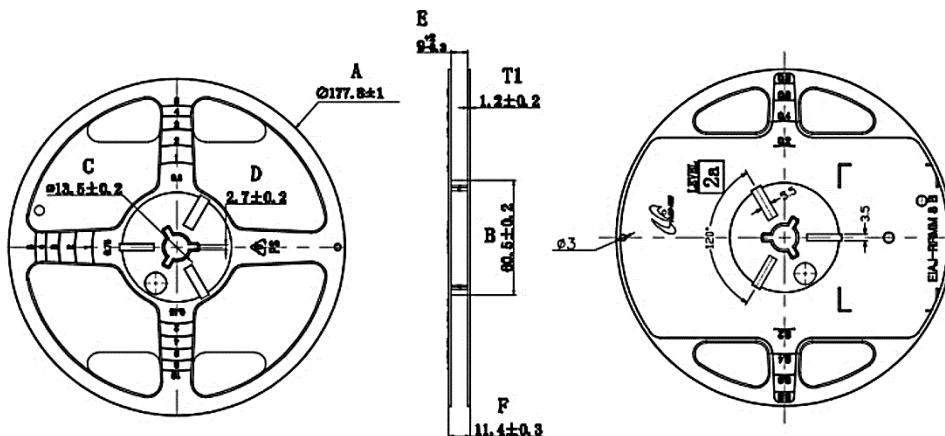

## **AUTO. PLCC-4 TOP LED SMD 3528 BDAM SERIES ORANGE**

### **APPLICATION NOTES - Part I**

- Storage: To avoid the moisture penetration, we recommend store in a dry box with a desiccant, The maximum storage temperature range is 40°C and a maximum humidity of RH60%.
- Use Precaution after Opening the Packaging: Recommend conditions after opening the package  
a) Sealing b) Temperature : 30°C Humidity: Less than RH50% c) Recommend to use up before 72hrs after opening the package.
- If the package has been opened more than 4 weeks(MSL\_2a) or the color desiccant changes, LED Components should be dried for 12hrs at 60±5°C. .
- Do not apply mechanical force or excess vibration during the cooling process to normal temperature after soldering.
- Do not rapidly cool device after soldering.
- The LED should not be mounted on warped portion of PCB.
- The LED should not be used in any type of fluid such as water, oil, organic solvent and etc. When washing is required, IPA (Isopropyl Alcohol) should be used.
- When the LEDs are in operation the maximum current should be decided after measuring the package temperature.
- Long time exposure of sunlight or occasional UV exposure will cause lens discoloration.
- The driving circuit must be designed to allow forward voltage only when it is ON or OFF. If the reverse voltage is applied to LED, migration can be generated resulting in LED damage.
- LEDs are sensitive to Electro-Static Discharge (ESD). Below is a list of suggestions that BND purposes to minimize these effects.
- The products are sensitive to static electricity or surge voltage. ESD can damage a die and it's Reliability. When handling the products, the following measures against electrostatic discharge are strongly recommended:

## **AUTO. PLCC-4 TOP LED SMD 3528 BDAM SERIES ORANGE**

### **APPLICATION NOTES - Part II**

- a) Increase in reverse leakage current lowered turn-on voltage
- b) Abnormal emissions from the LED at low current LED

The following recommendations are suggested to help minimize the potential for an ESD event.

- One or more recommended work area suggestions:
  - a) Dissipating static charge with conductive materials
  - b) Preventing charge generation with moisture
  - c) ESD safe storage containers ESD
  
- One or more personnel suggestion options:
  - a) Antistatic wrist-strap b) Antistatic material shoes c) Antistatic clothes
  
- Environmental controls: Humidity control (ESD gets worse in a dry environment).
  
- Handling Precautions: During processing, mechanical stress on the surface should be minimized as much as possible. Sharp objects of all types should not be used to pierce the sealing compound. In general, LEDs should only be handled from the side. By the way, this also applies to LEDs Without a silicone sealant, since the surface can also become scratched.
  
- NextGen suggests using isopropyl alcohol for cleaning. In case other solvents are used, it must be assured that these solvents do not dissolve the package or resin. Please do not mold this products into another resin (epoxy, urethane, etc.) and do not handle this Product with acid or sulfur material in sealed space.

The following recommendations are suggested to help minimize the potential for an ESD event.

- One or more recommended work area suggestions:
  - a) Dissipating static charge with conductive materials
  - b) Preventing charge generation with moisture
  - c) ESD safe storage containers ESD
  
- One or more personnel suggestion options:
  - a) Antistatic wrist-strap b) Antistatic material shoes c) Antistatic clothes
  
- Environmental controls: Humidity control (ESD gets worse in a dry environment)



## **AUTO. PLCC-4 TOP LED SMD 3528 BDAM SERIES ORANGE**

### **APPLICATION NOTES - Part III**

- Handling Precautions: During processing, mechanical stress on the surface should be minimized as much as possible. Sharp objects of all types should not be used to pierce the sealing compound. In general, LEDs should only be handled from the side. By the way, this also applies to LEDs Without a silicone sealant, since the surface can also become scratched.
- NextGen suggests using isopropyl alcohol for cleaning. In case other solvents are used, it must be assured that these solvents do not dissolve the package or resin. Please do not mold this products into another resin (epoxy, urethane, etc.) and do not handle this Product with acid or sulfur material in sealed space.
- The evaluation of eye safety occurs according to the standard IEC 62471:2006 (photo biological safety of lamps and lamp systems). Within the risk grouping system of this IEC standard, the device specified in this data sheet falls into the class exempt group (exposure time 10000 s). Under real circumstances (for exposure time, conditions of the eye pupils, observation distance), it is assumed that no endangerment to the eye exists from these devices. As a matter of principle, however, it should be mentioned that intense light sources have a high secondary exposure potential due to their blinding effect. When looking at bright light sources (e.g. headlights), temporary reduction in visual acuity and afterimages can occur, leading to irritation, annoyance, visual impairment, and even accidents, depending on the situation.
- Subcomponents of this device contain, in addition to other substances, metal filed materials including silver. Metal filed materials can be affected by environments that contain traces of aggressive substances. Therefore, we recommend that customers minimize device exposure to aggressive substances during storage, production, and use. Devices that showed visible discoloration when tested using the described tests above did show no performance deviations within failure limits during the stated test duration. Respective failure limits Notes are described in the IEC60810.

## **AUTO. PLCC-4 TOP LED SMD 3528 BDAM SERIES ORANGE**

### **GLOSSARY**

- **Brightness:** Brightness values are measured during a current pulse of typically 20ms, with an internal reproducibility of  $\pm 5\%$ .
- **Wavelength:** The wavelength is measured at a current pulse of typically 20ms, with an internal reproducibility of  $\pm 1.5$  nm.
- **Forward Voltage:** The forward voltage is measured during a current pulse of typically 20ms, with an internal reproducibility of  $\pm 0.05$  V.
- **Reverse Operation:** Continuous reverse operation is not allowed.
- **Thermal Resistance:** RthJA results from mounting on PC board.
- **Typical Values:** Due to the special conditions of the manufacturing processes of semiconductor devices, the typical data or calculated correlations of technical parameters can only reflect statistical figures. These do not necessarily correspond to the actual parameters of each single product, which could differ from the typical data and calculated correlations or the typical characteristic line. If requested, e.g. because of technical improvements, these typ. data will be changed without any further notice.
- **Characteristic curve:** In the range where the line of the graph is broken, you must expect higher differences between single devices within one packing unit.

## AUTO. PLCC-4 TOP LED SMD 3528 BDAM SERIES ORANGE

### IMPORTANT NOTES AND DISCLAIMER

- **ROHS COMPLIANCE:** The levels of RoHS restricted materials in this product are below the maximum concentration values (also referred to as the threshold limits) permitted for such substances, or are used in an exempted application, in accordance with EU RoHS Directive (EU) 2015/863 EC (RoHS3). RoHS Test Report for this product can be obtained at Download Center.
- **REACH COMPLIANCE:** REACH substances of high concern (SVHCs) information is available for this product. Since the European Chemical Agency (ECHA) has published notice of their intent to frequently revise the SVHC listing for the foreseeable future, REACH Test Report for this product can be obtained at Download Center.
- All Product parametric performance is indicated in the Electrical Characteristics for the listed herein test conditions, unless otherwise noted. Product performance may not be indicated by the Electrical Characteristics if operated under different conditions.
- NextGen Component, Inc (*NextGen*) reserves the right to make changes to this document and its products and specifications at any time without notice. Customers should obtain and confirm the latest product information and specifications before final design, purchase or use.
- *NextGen* makes no warranty, representation or guarantee regarding the suitability of its products for any particular purpose, not does *NextGen* assume any liability for application assistance or customer product design.
- *NextGen* does not warrant or accept any liability with products which are purchased or used for any unintended or unauthorized application. No license is granted by implication or otherwise under any intellectual property rights of NextGen.
- *NextGen* products are not authorized for use as critical components in life support devices or systems without express written approval by *NextGen*.
- *NextGen* requires that customers first obtain an RMA (Returned Merchandise Authorization) number prior to returning any products. Returns must be made within 30 days of the date of invoice, be in the original packaging, unused and like-new condition. At the time of quoting or purchasing, a product may say that it is Non-Cancelable/ Non-Returnable (NCNR). These products are not returnable and not refundable.