

MAX ECHO 鈺鎧科技股份有限公司規格標準書

COMPONENT SPECIFICATION

版次：第4.0版

MAX ECHO

Name	Ferrite Chip EMI Suppressors	COMPOSITE SPECIFICATION		1/8
	BCAS-160808	SPEC#	BCAS160808A801	

1. Scope

The BCAS series is suitable for noise suppression of digital interface from 500Mhz to 1Ghz

2. Standard and Atmospheric Conditions

Unless otherwise specified the standard range of atmospheric conditions for making measurements and tests is as follows:

Ambient temperature : 20±15°C

Relative humidity : 30~70%

If there may be any doubt on the results, measurements shall be made within the following limits :

Ambient temperature : 25±5°C

Relative humidity : 30~70%

3. Ratings

PART NO	IMPEDANCE (Ω) AT100 MHz 500mV	IMPEDANCE(Ω) AT 1 GHz 500mV	DCR(Ω) MAX Resistance	RATE (mA) CURRENT (MAX)
BCAS160808A801	800±25%	1000±40%	1.5	50

4. Dimensions

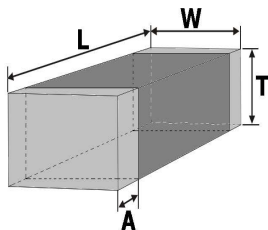

unit:
mm
(inch)

OPERATING TEMP. RANGE : -55°C ~ +125°C

STORAGE TEMP. RANGE : -10°C ~ +40°C

TYPE	L	W	T	A
BCAS-1608	1.6±0.15 (0.063±0.006)	0.8±0.15 (0.031±0.006)	0.8±0.15 (0.031±0.006)	0.2~0.6 (0.008~0.024)

5. The Place of Origin :

Taichung, Taiwan

PLANNED BY	CHECKED BY	APPROVED BY	<div style="border: 1px solid black; padding: 5px; display: inline-block;">鈺鎧文件中心 發行章</div>
LUN	林玉滿	JEFFERY	

MAX ECHO 鈺鎧科技股份有限公司規格標準書

COMPONENT SPECIFICATION

版次：第4.0版

MAX ECHO

Name	Ferrite Chip EMI Suppressors BCAS-160808	COMPOSITE SPECIFICATION		2 / 8
		SPEC#	BCAS160808A801	

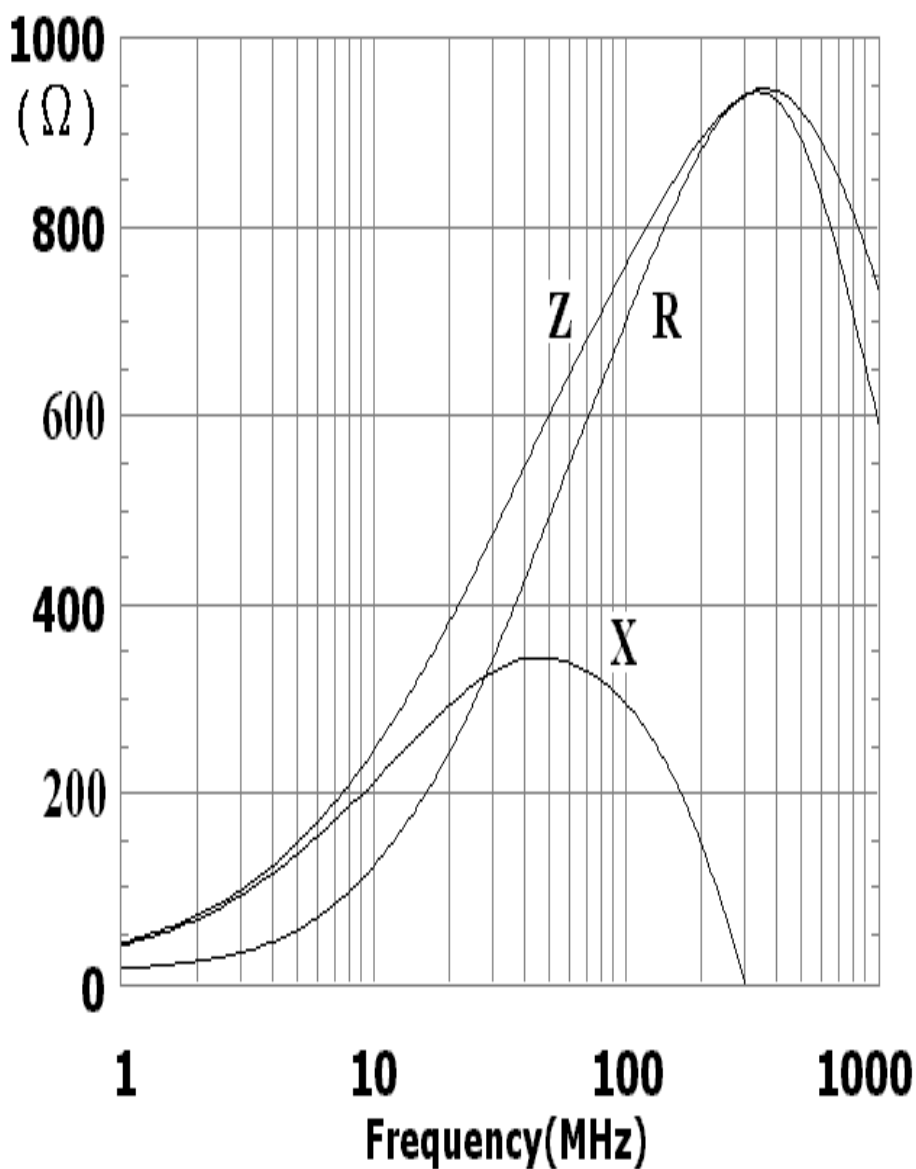

MAX ECHO 鈺鎧科技股份有限公司規格標準書

COMPONENT SPECIFICATION

版次：第4.0版

MAX ECHO

Name	Ferrite Chip EMI Suppressors	COMPOSITE SPECIFICATION		3 / 8
	BCAS-160808	SPEC#	BCAS160808A801	

6. Reflow soldering conditions

- Pre-heating should be in such a way that the temperature difference between solder and ferrite surface is limited to 150°C max. Also cooling into solvent after soldering should be in such a way that the temperature difference is limited to 100°C max. Insufficient pre-heating may cause cracks on the ferrite, resulting in the deterioration of product quality.
- Products should be soldered within the following allowable range indicated by the slanted line. The excessive soldering conditions may cause the corrosion of the electrode, when soldering is repeated, allowable time is the accumulated time.

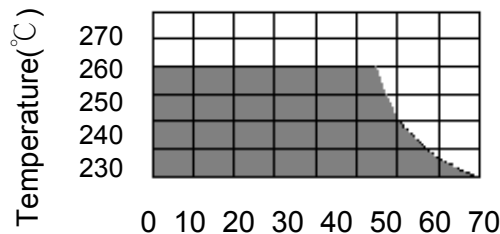

Temperature Profile

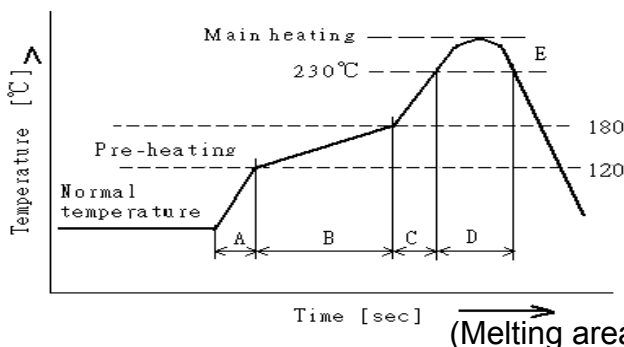

A	Slope of temp. rise	1 to 5	°C/sec
B	Heat time	50 to 150	sec
	Heat temperature	120 to 180	°C
C	Slope of temp. rise	1 to 5	°C/sec
D	Time over 230°C	90~120	sec
E	Peak temperature	255~260	°C
	Peak hold time	10 max.	sec
No. of mounting		3	times

6-1 Reworking with soldering iron

Preheating	150°C, 1 minute
Tip temperature	280°C max.
Soldering time	3 seconds max.
Soldering iron output	30w max.
End of soldering iron	φ 3mm max.

- Reworking should be limited to only one time.

Note : Do not directly touch the products with the tip of the soldering iron in order to prevent the crack on the ferrite material due to the thermal shock.

6-2 Solder Volume

Solder shall be used not to be exceed the upper limits as shown below.

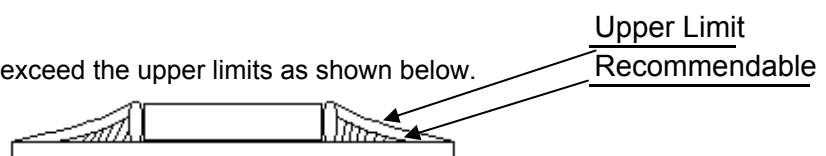

Accordingly increasing the solder volume, the mechanical stress to product is also increased. Exceeding solder volume may cause the failure of mechanical or electrical performance.

MAX ECHO 鈺鎧科技股份有限公司規格標準書

COMPONENT SPECIFICATION

版次：第4.0版

MAX ECHO

Name	Ferrite Chip EMI Suppressors	COMPOSITE SPECIFICATION		4 / 8
	BCAS-160808	SPEC#	BCAS160808A801	

7. Equipment

7-1 IMPEDANCE

Impedance shall be measured with HP – 4286A impedance analyzer or equivalent system

7-2 DC RESISTANCE

DC resistance shall be measured using HP 4338 digital milli – ohm meter with 4 terminal method.

8. Mechanical Characteristics

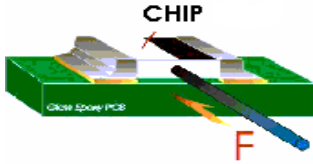
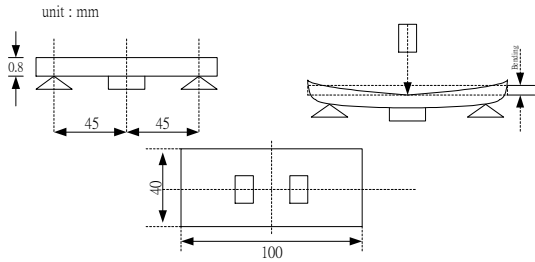
ITEM	Specification	Test Conditions
Terminal Strength	Without deformation cases impedance shall be satisfied $\pm 30\%$ DC resistance shall be satisfied.	Solder chip on PCB and applied 10N (1.02Kgf) for 10 sec 
Substrate Bending Test	Without deformation cases, impedance shall be satisfied $\pm 30\%$ DC resistance shall be satisfied.	After soldering a chip to a test substrate, bend the substrate by 3mm hold for 10s and then return. Soldering shall be done in accordance with the recommended PC board pattern and reflow soldering. 
Resistance to Solder Heat	No visible damage Electrical characteristics and mechanical characteristics shall be satisfied. Consult standard MIL-STD-202 METHOD 210	Solder Temp. : $265 \pm 3^\circ\text{C}$ Immersion time : 6 ± 1 sec Preheating : 100°C to 150°C , 1 minute. Measurement to be made after keeping at room temp for 24 ± 2 hrs. Solder : Sn-3Ag-0.5Cu
Solderability	95% min. coverage of all metallized area Consult standard J-STD-002	Solder temp. : $240 \pm 5^\circ\text{C}$ Immersion time : 3 ± 1 sec Solder : Sn-3Ag-0.5Cu

MAX ECHO 鈺鎧科技股份有限公司規格標準書

COMPONENT SPECIFICATION

版次：第4.0版

MAX ECHO

Name	Ferrite Chip EMI Suppressors BCAS-160808	COMPOSITE SPECIFICATION		5 / 8
		SPEC#	BCAS160808A801	
<p>9. Reliability and Test Conditions</p> <p>9-1 HIGH TEMPERATURE RESISTANCE</p> <p style="margin-left: 20px;">a. Performance specification</p> <p style="margin-left: 40px;">1. Appearance: no mechanical damage</p> <p style="margin-left: 40px;">2. Impedance shall be with $\pm 30\%$ of the initial value</p> <p style="margin-left: 40px;">3. DC resistance shall be satisfied</p> <p style="margin-left: 20px;">b. Test condition</p> <p style="margin-left: 40px;">1. Temperature $125^{\circ}\text{C} \pm 2^{\circ}\text{C}$</p> <p style="margin-left: 40px;">2. Applied current: Rated current (maximum value)</p> <p style="margin-left: 40px;">3. Testing time: 1008 ± 12 hrs</p> <p style="margin-left: 40px;">4. Measurement: After placing at room ambient temperature for 24 hours minimum</p> <p>9-2 HUMIDITY RESISTANCE</p> <p style="margin-left: 20px;">a. Performance specification</p> <p style="margin-left: 40px;">1. Appearance: no mechanical damage</p> <p style="margin-left: 40px;">2. Impedance: within $\pm 30\%$ of initial value</p> <p style="margin-left: 40px;">3. DC resistance shall be satisfied</p> <p style="margin-left: 20px;">b. Test condition</p> <p style="margin-left: 40px;">1. Humidity: 90 to 95% RH</p> <p style="margin-left: 40px;">2. Temperature: $60 \pm 2^{\circ}\text{C}$</p> <p style="margin-left: 40px;">3. Applied current: Rated current (maximum value)</p> <p style="margin-left: 40px;">4. Testing time: 1008 ± 12 hours</p> <p style="margin-left: 40px;">5. Measurement: After placing at room ambient temperature for 24 hours minimum</p> <p>9-3 TEMPERATURE CYCLE</p> <p style="margin-left: 20px;">a. Performance specification</p> <p style="margin-left: 40px;">1. Appearance: no mechanical damage</p> <p style="margin-left: 40px;">2. Impedance: within $\pm 30\%$ of initial value</p> <p style="margin-left: 40px;">3. DC resistance shall be satisfied</p> <p style="margin-left: 20px;">b. Test condition</p> <p style="margin-left: 40px;">1. Temperature -55°C, $+125^{\circ}\text{C}$ kept stabilized for 30 minutes each</p> <p style="margin-left: 40px;">2. Cycle: 100 cycles</p> <p style="margin-left: 40px;">3. Measurement: After placing for 24 hours minimum at room ambient temperature</p> <p style="margin-left: 40px;">4. step1. -55°C temp $\pm 3^{\circ}\text{C}$ 30 \pm 3 minutes</p> <p style="margin-left: 80px;">step2. Standard atmospheric conditions 5s or less</p> <p style="margin-left: 80px;">step3. $+125^{\circ}\text{C}$ temp $\pm 2^{\circ}\text{C}$ 30 \pm 3 minutes</p> <p style="margin-left: 80px;">step4. Standard atmospheric conditions 5s or less</p> <p>9-4 LOW TEMPERATURE STORAGE LIFE TEST</p> <p style="margin-left: 20px;">a. Performance specification</p> <p style="margin-left: 40px;">1. Appearance: no mechanical damage</p> <p style="margin-left: 40px;">2. Impedance shall be with $\pm 30\%$ of the initial value</p> <p style="margin-left: 40px;">3. DC resistance shall be satisfied</p> <p style="margin-left: 20px;">b. Test condition</p> <p style="margin-left: 40px;">1. Temperature $-55^{\circ}\text{C} \pm 2^{\circ}\text{C}$</p> <p style="margin-left: 40px;">2. Testing time: 1008 ± 12 hours</p> <p style="margin-left: 40px;">3. Measurement: After placing for 24 hours minimum at room ambient temperature</p> <p>9-5 THERMAL SHOCK</p> <p style="margin-left: 20px;">a. Performance specification</p> <p style="margin-left: 40px;">1. Appearance: no mechanical damage</p> <p style="margin-left: 40px;">2. Impedance shall be with $\pm 30\%$ of the initial value</p> <p style="margin-left: 20px;">b. Test condition</p> <p style="margin-left: 40px;">1. Temperature -55°C, $+125^{\circ}\text{C}$ kept stabilized for 30 minutes each</p> <p style="margin-left: 40px;">2. Cycle: 100 cycles</p> <p style="margin-left: 40px;">3. Measurement: After placing for 24 hours minimum at room ambient temperature</p> <p>9-6 VIBRATION TEST</p> <p style="margin-left: 20px;">a. Performance specification</p> <p style="margin-left: 40px;">1. Appearance: no mechanical damage</p> <p style="margin-left: 40px;">2. Impedance shall be with $\pm 30\%$ of the initial value</p> <p style="margin-left: 20px;">b. Test condition</p> <p style="margin-left: 40px;">1. Waveform: Sine wave</p> <p style="margin-left: 40px;">2. Frequency: 10~55~10 Hz</p> <p style="margin-left: 40px;">3. Sweep time: 1min</p> <p style="margin-left: 40px;">4. Amplitude: 1.5mm (peak-peak)</p> <p style="margin-left: 40px;">5. Direction: X, Y, Z (3 axes)</p> <p style="margin-left: 40px;">6. Duration: 2 hrs. /axis, total 6 hrs.</p>				

MAX ECHO 鈺鎧科技股份有限公司規格標準書

COMPONENT SPECIFICATION

版次：第4.0版

MAX ECHO

Name	Ferrite Chip EMI Suppressors	COMPOSITE SPECIFICATION		6 / 8
	BCAS-160808	SPEC#	BCAS160808A801	

PAPER CARRIER TYPE PACKING

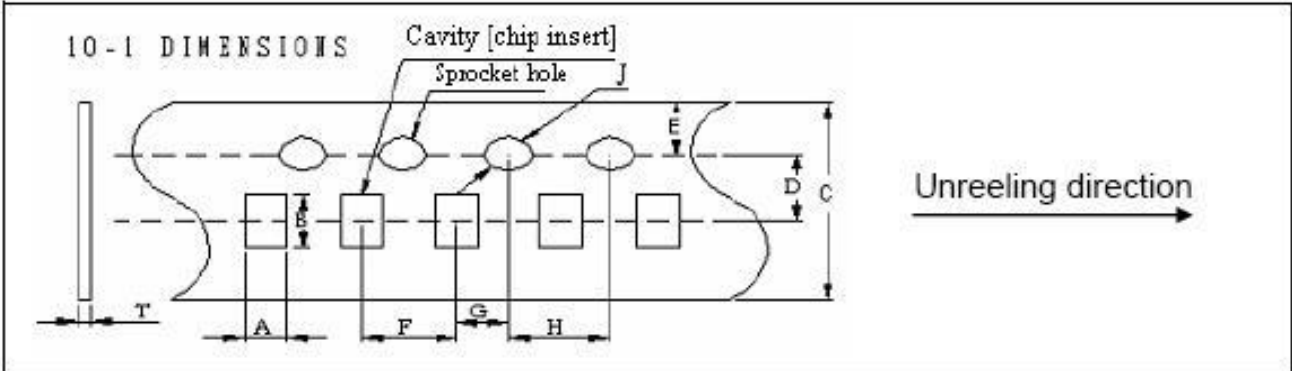

A	B	C	D	E	F	G	H	J	T
1.03	1.85	8.00	3.50	1.75	4.00	2.00	4.00	1.55	0.95
±0.05	±0.05	±0.10	±0.05	±0.10	±0.10	±0.05	±0.10	±0.05	±0.05

10-2 LEADER AND TRAILER TAPE

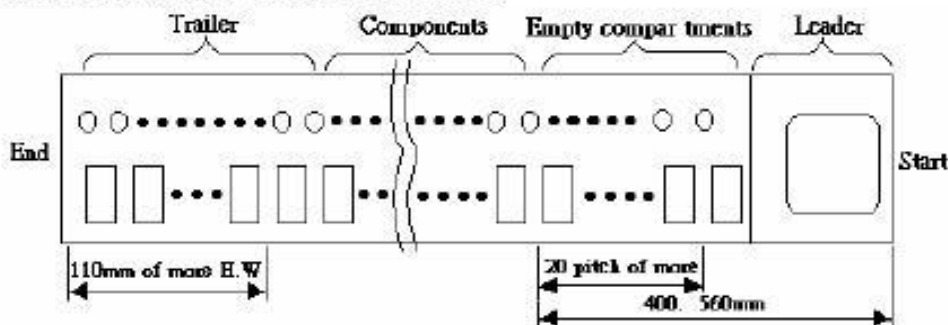

10-3 DIRECTION THE DIRECTION SHALL BE SEEN FROM THE TOP OF COVER TAPE



10-4 REELS

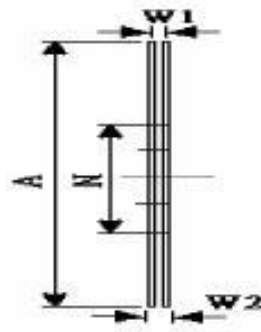
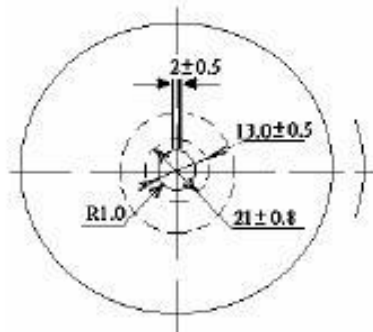

UNIT:mm

A	178 ±2.0
N	50 MIN
W1	10 ±1.5
W2	20 MAX

PACKING QTY.
4,000 PCS REEL

MAX ECHO 鈺鎧科技股份有限公司規格標準書

COMPONENT SPECIFICATION

版次：第4.0版

MAX ECHO

Name	Ferrite Chip EMI Suppressors	COMPOSITE SPECIFICATION		7 / 8
	BCAS-160808	SPEC#	BCAS160808A801	

10-5 PEELING STRENGTH OF COVER TAPE

Cover tape	(10g~100g)
------------	------------

165°~180°

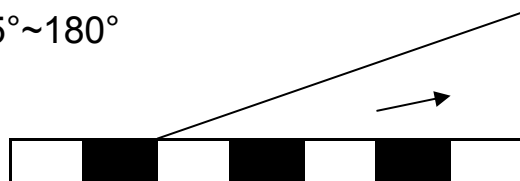

Test condition

1. peel angle : 165°~180° vs carrier tape
2. peel speed : 300mm/min

11. Packaging

1. Tape & Reel packaging in composite specification 6/8
- 2) Reel and a bag of desiccant shall be packed in Nylon or plastic bag
- 3) Maximum of 5 reels shall be packaged in a inner box
- 4) Maximum of 6 inner box shall be packaged in a outer box

12. Reel Label

Producing the goods label needs to indicate (1) Pb Free (2) RoHS Compliant

MAX ECHO 鈺鎧科技股份有限公司規格標準書

COMPONENT SPECIFICATION

版次：第4.0版

MAX ECHO

NAME	Ferrite Chip EMI Suppressors	COMPOSITE SPECIFICATION		8 / 8
	BCAS-160808	SPEC#	BCAS160808A801	

13. Storage

- 13-1 The solderability of the external electrode may be deteriorated if packages are stored where they are exposed to high humidity. Packages must be stored at 40°C or less and 70% RH or less.
- 13-2 The solderability of the external electrode may be deteriorated if packages are stored where they are exposed to dust or harmful gas (hydrogen chloride, sulfurous acid gas or hydrogen sulfide).
- 13-3 Packaging material may be deformed if packages are stored where they are exposed to heat or direct sun – light.
- 13-4 Minimum packages, such as polyvinyl heat – seal packages shall not be opened until just before they are used. If opened, use the reels as soon as possible.
- 13-5 Solderability specified in composite specification 4/8 shall be for 6 months from the date of delivery on condition that they are stored at the environment specified clause 13-1 & 13-2.
For those parts which passed more than 6 months shall be checked solderability before it is used.

14. Quality System

- ISO/TS16949
- IECQ QC 080000