

# MAX ECHO 鈺鎧科技股份有限公司規格標準書 COMPONENT SPECIFICATION

版次：第5.0版

MAX ECHO

|      |                              |                         |                |             |
|------|------------------------------|-------------------------|----------------|-------------|
| Name | Ferrite Chip EMI Suppressors | COMPOSITE SPECIFICATION |                | 1<br>/<br>8 |
|      | BCAS-160808                  | SPEC#                   | BCAS160808A601 |             |

### 1. Scope

The BCAS series is suitable for noise suppression of digital interface from 500Mhz to 1Ghz

### 2. Standard and Atmospheric Conditions

Unless otherwise specified the standard range of atmospheric conditions for making measurements and tests is as follows:

Ambient temperature : 20±15°C

Relative humidity : 30~70%

If there may be any doubt on the results, measurements shall be made within the following limits :

Ambient temperature : 25±5°C

Relative humidity : 30~70%

### 3. Ratings

| PART NO        | IMPEDANCE (Ω)<br>AT100 MHz 500mV(typ) | IMPEDANCE(Ω)<br>AT 1 GHz 500mV(typ) | DCR(Ω) MAX<br>Resistance | RATE (mA)<br>CURRENT (MAX) |
|----------------|---------------------------------------|-------------------------------------|--------------------------|----------------------------|
| BCAS160808A601 | 600±25%                               | 700±40%                             | 0.9                      | 100                        |

### 4. Dimensions

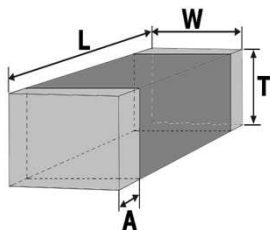

unit:  
mm  
(inch)

OPERATING TEMP. RANGE : -55°C ~ +125°C

STORAGE TEMP. RANGE : -40°C ~ +85°C

| TYPE      | L                         | W                         | T                         | A                        |
|-----------|---------------------------|---------------------------|---------------------------|--------------------------|
| BCAS-1608 | 1.6±0.15<br>(0.063±0.006) | 0.8±0.15<br>(0.031±0.006) | 0.8±0.15<br>(0.031±0.006) | 0.2~0.6<br>(0.008~0.024) |

### 5. The Place of Origin :

Taichung, Taiwan

|            |            |               |   |
|------------|------------|---------------|---|
| PLANNED BY | CHECKED BY | APPROVED BY   | <div style="border: 1px solid black; padding: 5px; display: inline-block;">                 鈺鎧文件中心<br/>發行章             </div> |
| LUN        | TINA       | Chi Chi Huang |   |

# MAX ECHO 鈺鎧科技股份有限公司規格標準書

## COMPONENT SPECIFICATION

版次：第5.0版

MAX ECHO

|      |                              |                         |                |       |
|------|------------------------------|-------------------------|----------------|-------|
| Name | Ferrite Chip EMI Suppressors | COMPOSITE SPECIFICATION |                | 2 / 8 |
|      | BCAS-160808                  | SPEC#                   | BCAS160808A601 |       |

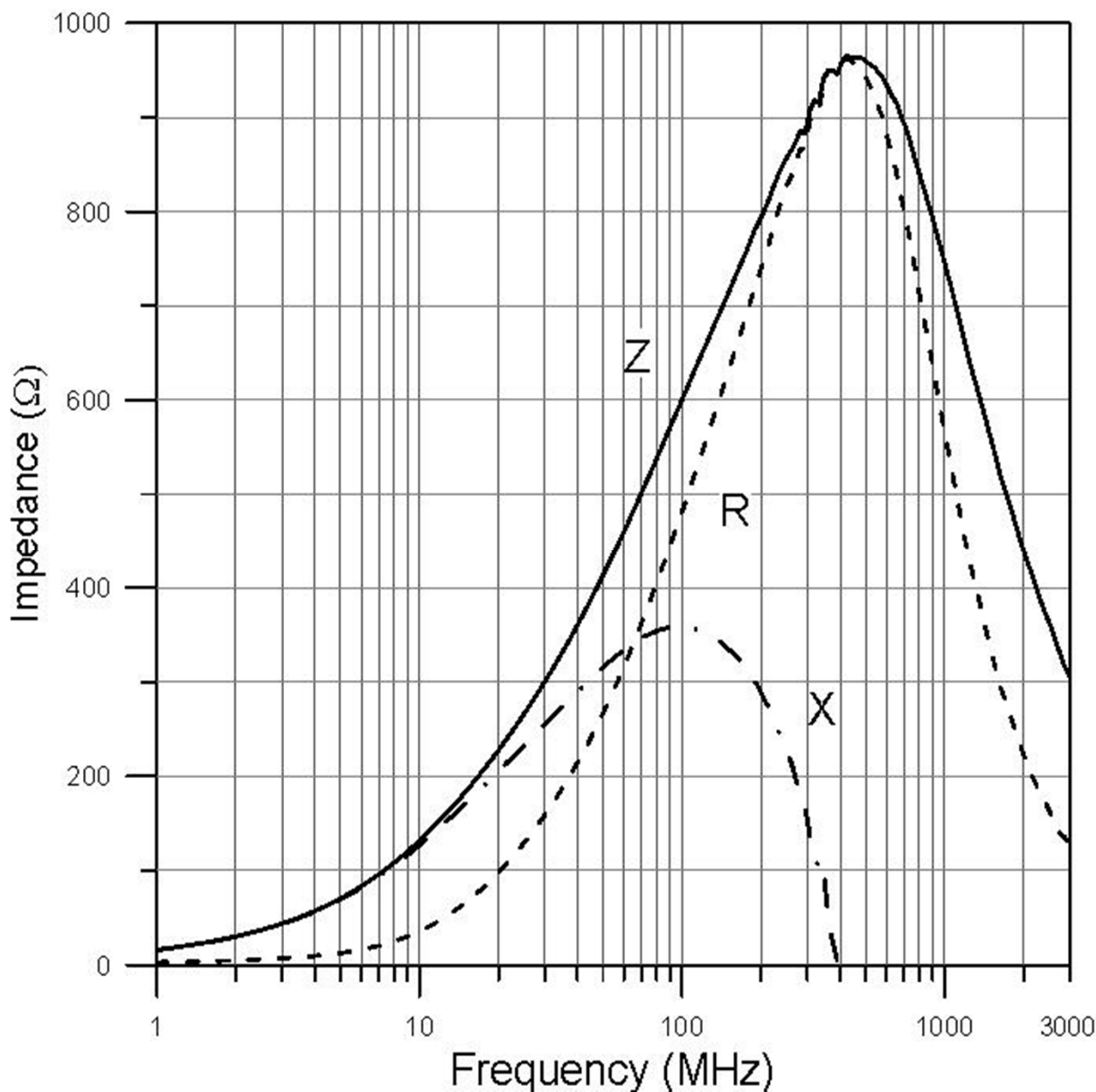

# MAX ECHO 鈺鎧科技股份有限公司規格標準書

## COMPONENT SPECIFICATION

版次：第5.0版

MAX ECHO

|      |                              |                         |                |       |
|------|------------------------------|-------------------------|----------------|-------|
| Name | Ferrite Chip EMI Suppressors | COMPOSITE SPECIFICATION |                | 3 / 8 |
|      | BCAS-160808                  | SPEC#                   | BCAS160808A601 |       |

### 6. Reflow soldering conditions

- Pre-heating should be in such a way that the temperature difference between solder and ferrite surface is limited to 150°C max. Also cooling into solvent after soldering should be in such a way that the temperature difference is limited to 100°C max. Insufficient pre-heating may cause cracks on the ferrite, resulting in the deterioration of product quality.
- Products should be soldered within the following allowable range indicated by the slanted line. The excessive soldering conditions may cause the corrosion of the electrode, when soldering is repeated, allowable time is the accumulated time.

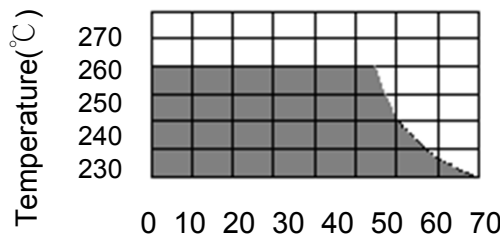

#### Temperature Profile

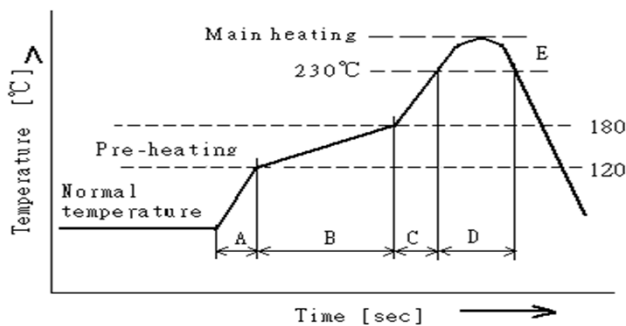

|                 |                     |            |        |
|-----------------|---------------------|------------|--------|
| A               | Slope of temp. rise | 1 to 5     | °C/sec |
| B               | Heat time           | 50 to 150  | sec    |
|                 | Heat temperature    | 120 to 180 | °C     |
| C               | Slope of temp. rise | 1 to 5     | °C/sec |
| D               | Time over 230°C     | 90~120     | sec    |
| E               | Peak temperature    | 255~260    | °C     |
|                 | Peak hold time      | 10 max.    | sec    |
| No. of mounting |                     | 3          | times  |

(Melting area of solder)

#### 6-1 Reworking with soldering iron

|                       |                 |
|-----------------------|-----------------|
| Preheating            | 150°C, 1 minute |
| Tip temperature       | 280°C max.      |
| Soldering time        | 3 seconds max.  |
| Soldering iron output | 30w max.        |
| End of soldering iron | φ 3mm max.      |

- Reworking should be limited to only one time.

Note : Do not directly touch the products with the tip of the soldering iron in order to prevent the crack on the ferrite material due to the thermal shock.

#### 6-2 Solder Volume

Solder shall be used not to be exceed the upper limits as shown below.

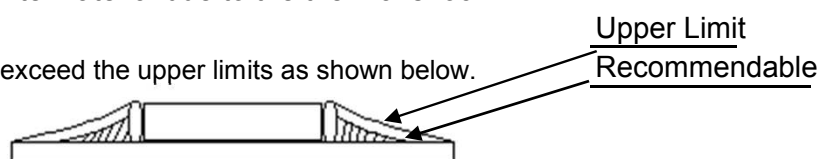

Accordingly increasing the solder volume, the mechanical stress to product is also increased. Exceeding solder volume may cause the failure of mechanical or electrical performance.

# MAX ECHO 鈺鎧科技股份有限公司規格標準書

## COMPONENT SPECIFICATION

版次：第5.0版

MAX ECHO

|      |                              |                         |                |       |
|------|------------------------------|-------------------------|----------------|-------|
| Name | Ferrite Chip EMI Suppressors | COMPOSITE SPECIFICATION |                | 4 / 8 |
|      | BCAS-160808                  | SPEC#                   | BCAS160808A601 |       |

### 7. Equipment

#### 7-1 IMPEDANCE

Impedance shall be measured with HP – 4286A impedance analyzer or equivalent system

#### 7-2 DC RESISTANCE

DC resistance shall be measured using HP 4338 digital milli – ohm meter with 4 terminal method.

### 8. Mechanical Characteristics

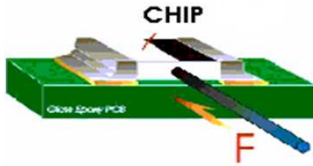
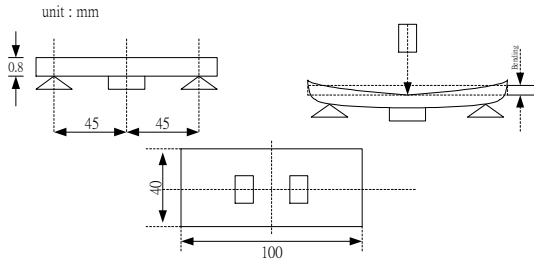
| ITEM                      | Specification  | Test Conditions  |
|---------------------------|--|--|
| Terminal Strength         | Terminal strength does not distort the case shall meet SPEC DC resistance specifications.  | Solder chip on PCB and applied 10N (1.02Kgf) for 10 sec<br>  |
| Substrate Bending Test    | SPEC substrate bending test DC resistance shall meet specifications.   | After soldering a chip to a test substrate, bend the substrate by 3mm hold for 10s and then return.<br>Soldering shall be done in accordance with the recommended PC board pattern and reflow soldering.<br> |
| Resistance to Solder Heat | No visible damage<br>Electrical characteristics and mechanical characteristics shall be satisfied.<br><b>Consult standard MIL-STD-202 METHOD 210</b> | Solder Temp. : 265±3°C<br>Immersion time : 6±1 sec<br>Preheating : 100°C to 150°C, 1 minute.<br>Measurement to be made after keeping at room temp for 24±2 hrs.<br>Solder : Sn-3Ag-0.5Cu   |
| Solderability             | 95% min. coverage of all metallized area<br><b>Consult standard J-STD-002</b>  | Solder temp. : 240±5°C<br>Immersion time : 3±1 sec<br>Solder : Sn-3Ag-0.5Cu  |

# MAX ECHO 鈺鎧科技股份有限公司規格標準書

## COMPONENT SPECIFICATION

版次：第5.0版

MAX ECHO

| Name   | Ferrite Chip EMI Suppressors |  | COMPOSITE SPECIFICATION |                | 5 / 8 |
|--|------------------------------|--|-------------------------|----------------|-------|
|  | BCAS-160808                  |  | SPEC#                   | BCAS160808A601 |       |
| <p>9. RELIABILITY AND TEST CONDITIONS</p> <p>9-1 HIGH TEMPERATURE RESISTANCE</p> <p style="margin-left: 20px;">a. Performance specification</p> <p style="margin-left: 40px;">1. Appearance : no mechanical damage</p> <p style="margin-left: 40px;">2. Impedance shall be with <math>\pm 30\%</math> of the initial value</p> <p style="margin-left: 20px;">b. Test condition</p> <p style="margin-left: 40px;">1. Temperature: <math>125^{\circ}\text{C} \pm 2^{\circ}\text{C}</math></p> <p style="margin-left: 40px;">2. Testing time : <math>1000 \pm 12\text{hrs}</math></p> <p style="margin-left: 40px;">3. Measurement : After placing at room ambient temperature for 24 hours minimum</p> <p>9-2 Biased Humidity RESISTANCE</p> <p style="margin-left: 20px;">a. Performance specification</p> <p style="margin-left: 40px;">1. Appearance : no mechanical damage</p> <p style="margin-left: 40px;">2. Impedance shall be with <math>\pm 30\%</math> of the initial value</p> <p style="margin-left: 20px;">b. Test condition</p> <p style="margin-left: 40px;">1. Humidity: <math>85 \pm 5\% \text{RH}</math></p> <p style="margin-left: 40px;">2. Temperature: <math>85^{\circ}\text{C} \pm 2^{\circ}\text{C}</math></p> <p style="margin-left: 40px;">3. Testing time: <math>1000 \pm 12\text{ hours}</math></p> <p style="margin-left: 40px;">4. Measurement : After placing at room ambient temperature for 24 hours minimum</p> <p>9-3 TEMPERATURE CYCLE</p> <p style="margin-left: 20px;">a. Performance specification</p> <p style="margin-left: 40px;">1. Appearance : no mechanical damage</p> <p style="margin-left: 40px;">2. Impedance shall be with <math>\pm 30\%</math> of the initial value</p> <p style="margin-left: 20px;">b. Test condition</p> <p style="margin-left: 40px;">1. Low Temperature: <math>-55^{\circ}\text{C} \pm 5^{\circ}\text{C}</math> kept stabilized for 30 minutes each</p> <p style="margin-left: 40px;">2. High Temperature: <math>125^{\circ}\text{C} \pm 5^{\circ}\text{C}</math> kept stabilized for 30 minutes each</p> <p style="margin-left: 40px;">2. Cycle : 1000 cycles</p> <p style="margin-left: 40px;">3. Measurement : After placing for 24hours minimum at room ambient temperature</p> <p style="margin-left: 40px;">4. step1. <math>-55^{\circ}\text{C} \text{ temp} \pm 5^{\circ}\text{C} \ 30 \pm 3\text{ minutes}</math></p> <p style="margin-left: 80px;">step2. Room temperature 2to5 minutes</p> <p style="margin-left: 80px;">step3. <math>+125^{\circ}\text{C} \text{ temp} \pm 5^{\circ}\text{C} \ 30 \pm 3\text{ minutes}</math></p> <p style="margin-left: 80px;">step4. room temperature 2to5 minutes</p> <p>9-4 VIBRATION TEST</p> <p style="margin-left: 20px;">a. Performance specification</p> <p style="margin-left: 40px;">1. Appearance : no mechanical damage</p> <p style="margin-left: 40px;">2. Impedance shall be with <math>\pm 30\%</math> of the initial value</p> <p style="margin-left: 20px;">b. Test condition</p> <p style="margin-left: 40px;">1. Frequency and Amplitude: 10-2000-10Hz</p> <p style="margin-left: 40px;">2. Direction: X, Y, Z.</p> <p style="margin-left: 40px;">3. Test duration: 4 hours for each direction, 12 hours in total.</p> <p>9-5 Mechanical Shock TEST</p> <p style="margin-left: 20px;">a. Performance specification</p> <p style="margin-left: 40px;">1. Appearance : no mechanical damage</p> <p style="margin-left: 40px;">2. Impedance shall be with <math>\pm 30\%</math> of the initial value</p> <p style="margin-left: 20px;">b. Test condition</p> <p style="margin-left: 40px;">1. peak acceleration : 100 g's</p> <p style="margin-left: 40px;">2. Duration of pulse : 6 ms</p> <p style="margin-left: 40px;">3. Waveform : Half-sine</p> <p style="margin-left: 40px;">4. Velocity change : 12.3 ft/sec</p> <p style="margin-left: 40px;">5. Direction : X , Y , Z ( 3axes/3 times )</p> <p>9-6 Operational Life</p> <p style="margin-left: 20px;">a. Performance specification</p> <p style="margin-left: 40px;">1. Appearance : no mechanical damage</p> <p style="margin-left: 40px;">2. Impedance shall be with <math>\pm 30\%</math> of the initial value</p> <p style="margin-left: 20px;">b. Test condition</p> <p style="margin-left: 40px;">1. Temperature: <math>125^{\circ}\text{C} \pm 2^{\circ}\text{C}</math></p> <p style="margin-left: 40px;">2. Testing time : <math>1000 \pm 12\text{hrs}</math></p> <p style="margin-left: 40px;">3. Measurement : After placing at room ambient temperature for 24 hours minimum</p> <p>9-7 Electrostatic discharge test</p> <p style="margin-left: 20px;">a. Performance specification</p> <p style="margin-left: 40px;">1. Appearance : no mechanical damage</p> <p style="margin-left: 40px;">2. Impedance shall be with <math>\pm 30\%</math> of the initial value</p> <p style="margin-left: 20px;">b. Test condition</p> <p style="margin-left: 40px;">1. ESD voltage: 15k volts</p> <p style="margin-left: 40px;">2. Mode 1: 150 pF/330 Ohm</p> <p style="margin-left: 40px;">3. Mode 2: 150 pF/2000 Ohm</p> <p>9.1 REMARK</p> <p>The reliability test customers if there are special requirements in accordance with customer needs</p> |                              |  |                         |                |       |

# MAX ECHO 鈺鎧科技股份有限公司規格標準書

## COMPONENT SPECIFICATION

版次：第5.0版

MAX ECHO

|      |                              |                         |                |       |
|------|------------------------------|-------------------------|----------------|-------|
| Name | Ferrite Chip EMI Suppressors | COMPOSITE SPECIFICATION |                | 6 / 8 |
|      | BCAS-160808                  | SPEC#                   | BCAS160808A601 |       |

### PAPER CARRIER TYPE PACKING

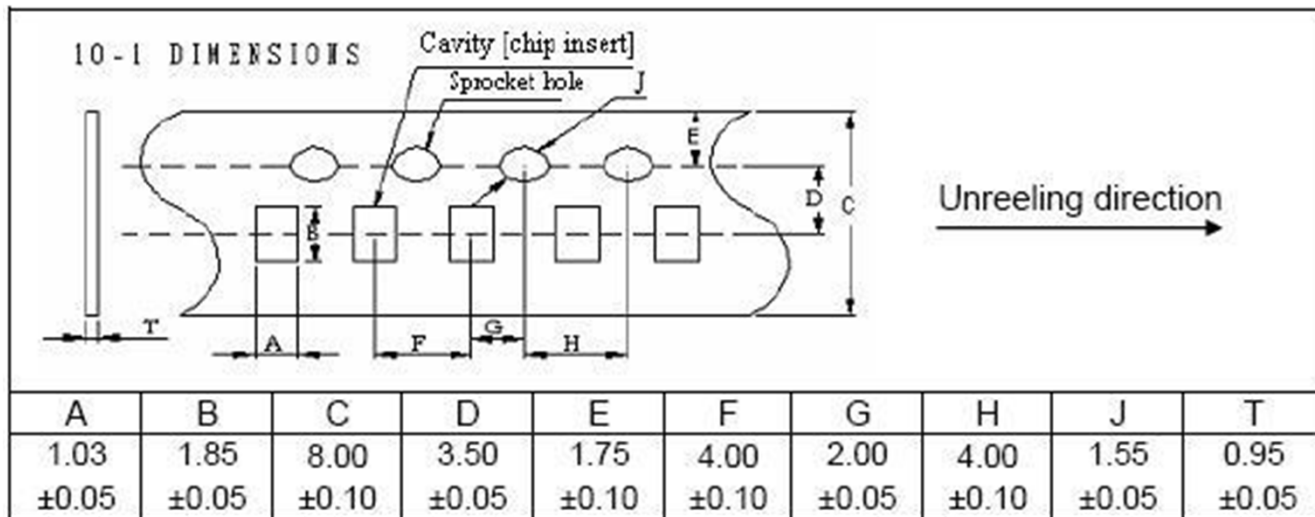

### 10-2 LEADER AND TRAILER TAPE

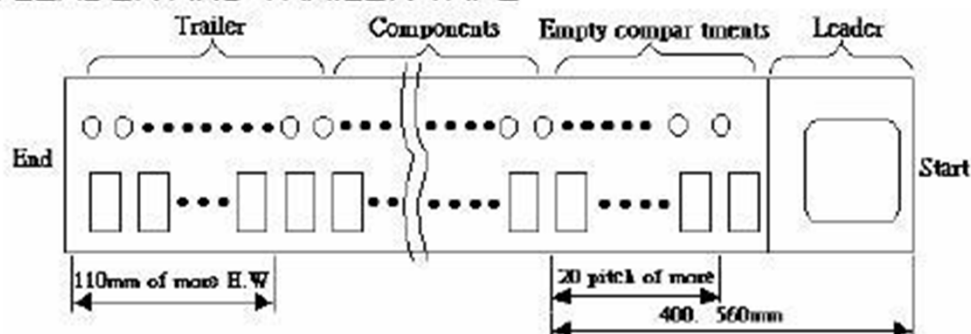

### 10-3 DIRECTION THE DIRECTION SHALL BE SEEN FROM THE TOP OF COVER TAPE



### 10-4 REELS

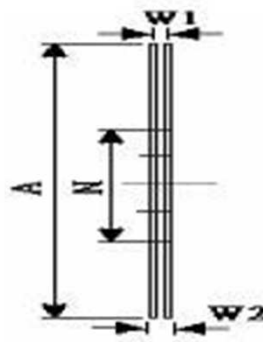
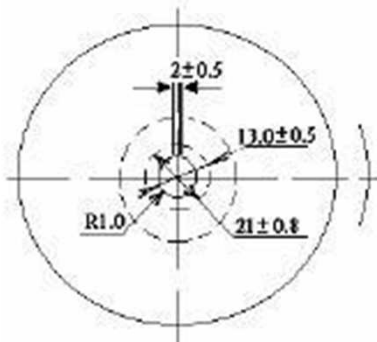

UNIT:mm

|    |             |
|----|-------------|
| A  | 178<br>±2.0 |
| N  | 50<br>MIN   |
| W1 | 10<br>±1.5  |
| W2 | 20<br>MAX   |

PACKING QTY.  
4,000 PCS REEL

# MAX ECHO 鈺鎧科技股份有限公司規格標準書 COMPONENT SPECIFICATION

版次：第5.0版

MAX ECHO

|      |                              |                         |                |       |
|------|------------------------------|-------------------------|----------------|-------|
| Name | Ferrite Chip EMI Suppressors | COMPOSITE SPECIFICATION |                | 7 / 8 |
|      | BCAS-160808                  | SPEC#                   | BCAS160808A601 |       |

## 10-5 PEELING STRENGTH OF COVER TAPE

|            |            |
|------------|------------|
| Cover tape | (10g~100g) |
|------------|------------|

165°~180°

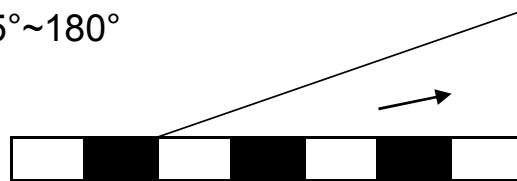

### Test condition

1. peel angle : 165°~180° vs carrier tape
2. peel speed : 300mm/min

### 11. Packaging

1. Tape & Reel packaging in composite specification 6/8
- 2) Reel and a bag of desiccant shall be packed in Nylon or plastic bag
- 3) Maximum of 5 reels shall be packaged in a inner box
- 4) Maximum of 6 inner box shall be packaged in a outer box

### 12. Reel Label

Producing the goods label needs to indicate (1 ) Pb Free (2) RoHS Compliant

# MAX ECHO 鈺鎧科技股份有限公司規格標準書

## COMPONENT SPECIFICATION

版次：第5.0版

MAX ECHO

|   |                              |                         |                |       |
|---|------------------------------|-------------------------|----------------|-------|
| NAME  | Ferrite Chip EMI Suppressors | COMPOSITE SPECIFICATION |                | 8 / 8 |
|   | BCAS-160808                  | SPEC#                   | BCAS160808A601 |       |
| <p><b>13. Storage</b></p> <p>13-1 The solderability of the external electrode may be deteriorated if packages are stored where they are exposed to high humidity. Packages must be stored at 40°C or less and 70% RH or less.</p> <p>13-2 The solderability of the external electrode may be deteriorated if packages are stored where they are exposed to dust or harmful gas (hydrogen chloride, sulfurous acid gas or hydrogen sulfide).</p> <p>13-3 Packaging material may be deformed if packages are stored where they are exposed to heat or direct sun – light.</p> <p>13-4 Minimum packages, such as polyvinyl heat – seal packages shall not be opened until just before they are used. If opened, use the reels as soon as possible.</p> <p>13-5 Solderability specified in composite specification 4/8 shall be for 6 months from the date of delivery on condition that they are stored at the environment specified clause 13-1 &amp; 13-2.</p> <p>For those parts which passed more than 6 months shall be checked solderability before it is used.</p> <p><b>14. Quality System</b></p> <ul style="list-style-type: none"> <li>■ ISO/TS16949</li> <li>■ IECQ QC 080000</li> </ul> |                              |                         |                |       |