

**DESIGNED & DIMENSIONED
IN MILLIMETERS [INCHES]**

DO NOT
SCALE FROM
THIS PRINT

TABLE 1		
ITEM	COMPONENT	-H
1	HEX NUT	SMA-NUT-001-F
2	LOCK WASHER	SMA-LWAS-001-F
3	SUB ASSEMBLY	SUB-SMA-J-C-F-ST-BH1
4	PIN	SMA-SKT-001-H
5	OUTER FERRULE	SMA-FER-001-F

SMA-J-C-X-ST-BH1-X

- GENDER
 - J: JACK
- TYPE
 - C: CABLE
- PACKAGING
 - BLANK: INDIVIDUALLY BAGGED
 - B: BULK PACKAGED (QTY=100 MAX)
- TERMINATION
 - BH1: BULKHEAD 1 (RG174 OR RG316)
- ORIENTATION
 - ST: STRAIGHT
- PLATING SPECIFICATION
 - H: 30µ" GOLD CENTER CONTACT, 3µ" GOLD OUTER CONTACT (SEE TABLE 1)

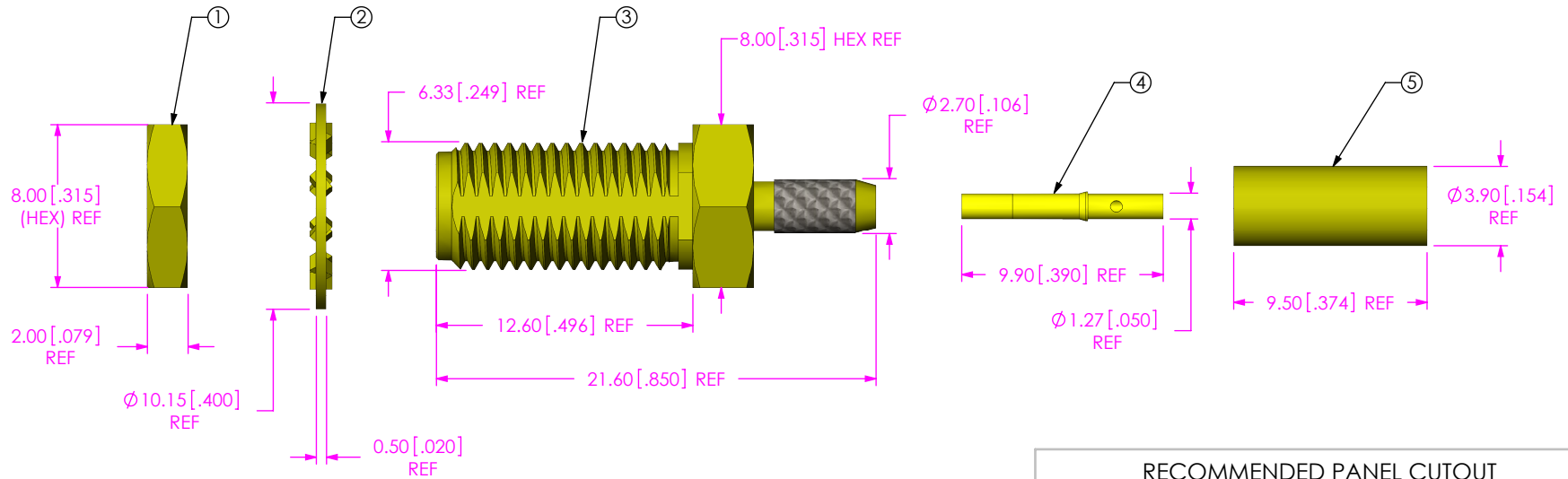
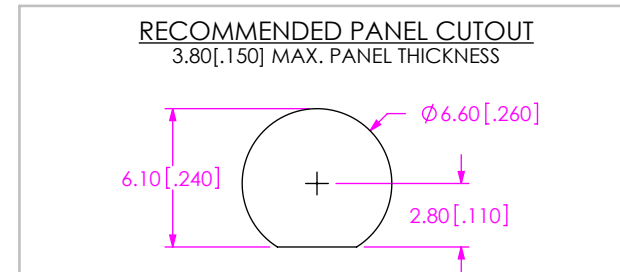

FIG1
SMA-J-C-X-ST-BH1 SHOWN



NOTES:

1. NOTE DELETED.
2. NOTE DELETED.
3. NOTE DELETED.
4. NOTE DELETED.
5. PRODUCT TO BE PACKAGED PER PRECISION RF SECTION OF PACKAGING MANUAL.
6. NOTE DELETED.
7. NOTE DELETED.
8. NOTE DELETED.

UNLESS OTHERWISE SPECIFIED, DIMENSIONS ARE IN MILLIMETERS [INCHES]. TOLERANCES ARE:

DECIMALS	ANGLES
X.X: ±0.3 [.01]	5°
X.XX: ±0.13 [.005]	
X.XXX: ±0.051 [.0020]	

MATERIAL: DO NOT SCALE DRAWING SHEET SCALE: 4:1
SHELL, FERRULE, NUT, WASHER: BRASS
CONTACT: COPPER ALLOY
DIELECTRIC: PTFE

PROPRIETARY NOTE
THIS DOCUMENT CONTAINS CONFIDENTIAL AND PROPRIETARY INFORMATION AND ALL DESIGN, MANUFACTURING, REPRODUCTION, USE, PATENT RIGHTS AND SALES RIGHTS ARE EXPRESSLY RESERVED BY SAMTEC, INC. THIS DOCUMENT SHALL NOT BE DISCLOSED, IN WHOLE OR PART, TO ANY UNAUTHORIZED PERSON OR ENTITY NOR REPRODUCED, TRANSFERRED OR INCORPORATED IN ANY OTHER PROJECT IN ANY MANNER WITHOUT THE EXPRESS WRITTEN CONSENT OF SAMTEC, INC.

samtec
520 PARK EAST BLVD, NEW ALBANY, IN 47150
PHONE: 812-944-6733 FAX: 812-948-5047
e-Mail: info@SAMTEC.com code: 55322

DESCRIPTION:
SMA STR JACK BULKHEAD, RG174 & RG316- 50 OHM
DWG. NO. **SMA-J-C-X-ST-BH1-X**
BY: R MUSSER 01/14/2008 SHEET 1 OF 3

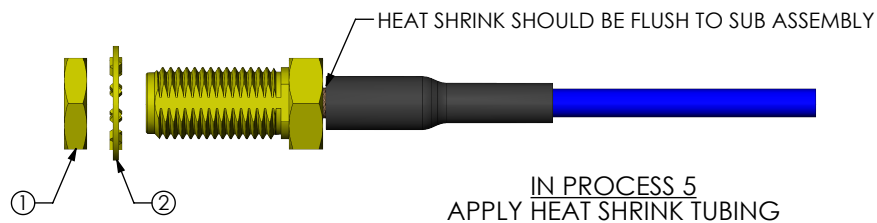
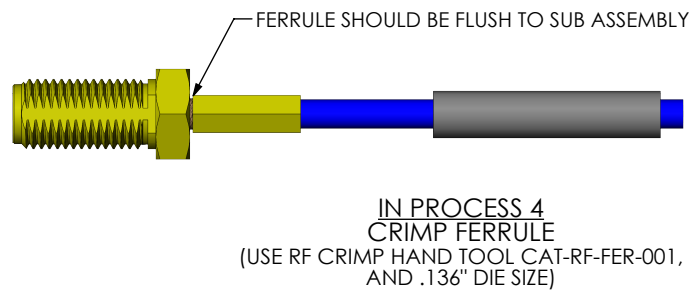
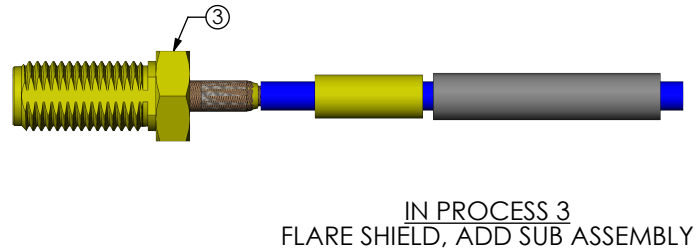
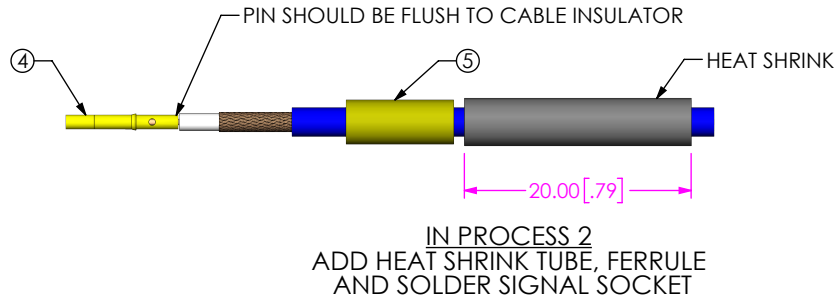
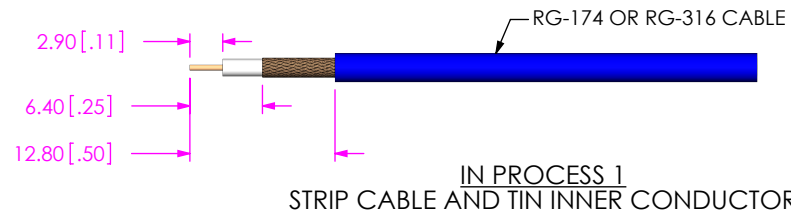

PROPRIETARY NOTE
THIS DOCUMENT CONTAINS CONFIDENTIAL AND PROPRIETARY INFORMATION AND ALL DESIGN, MANUFACTURING, REPRODUCTION, USE, PATENT RIGHTS AND SALES RIGHTS ARE EXPRESSLY RESERVED BY SAMTEC, INC. THIS DOCUMENT SHALL NOT BE DISCLOSED, IN WHOLE OR PART, TO ANY UNAUTHORIZED PERSON OR ENTITY NOR REPRODUCED, TRANSFERRED OR INCORPORATED IN ANY OTHER PROJECT IN ANY MANNER WITHOUT THE EXPRESS WRITTEN CONSENT OF SAMTEC, INC.

DO NOT SCALE DRAWING

SHEET SCALE: 1.5:1



520 PARK EAST BLVD, NEW ALBANY, IN 47150
PHONE: 812-944-6733 FAX: 812-948-5047
e-Mail: info@SAMTEC.com code: 55322

DESCRIPTION:
SMA STR JACK BULKHEAD, RG174 & RG316- 50 OHM

DWG. NO. SMA-J-C-X-ST-BH1-X

BY: R MUSSER 01/14/2008 SHEET 2 OF 3

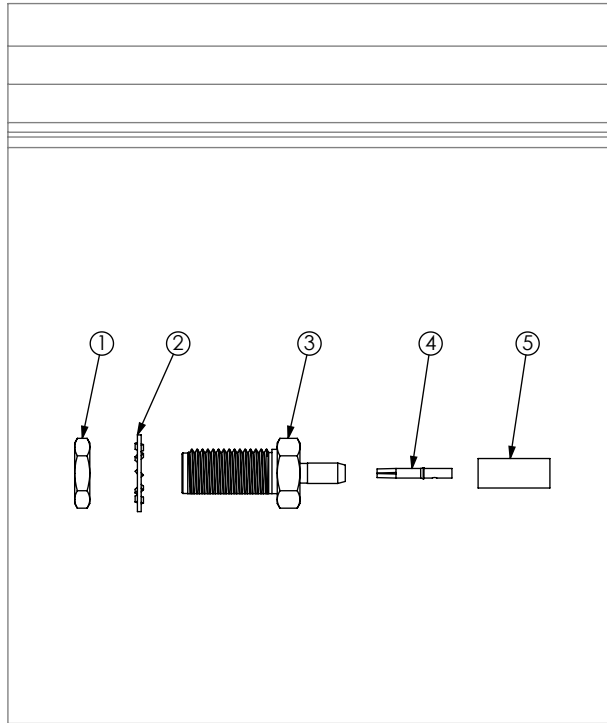

FIG 2
SMA-J-C-X-ST-BH1 SHOWN

• PROPRIETARY NOTE •
THIS DOCUMENT CONTAINS CONFIDENTIAL AND PROPRIETARY INFORMATION AND ALL DESIGN, MANUFACTURING, REPRODUCTION, USE, PATENT RIGHTS AND SALES RIGHTS ARE EXPRESSLY RESERVED BY SAMTEC, INC. THIS DOCUMENT SHALL NOT BE DISCLOSED, IN WHOLE OR PART, TO ANY UNAUTHORIZED PERSON OR ENTITY NOR REPRODUCED, TRANSFERRED OR INCORPORATED IN ANY OTHER PROJECT IN ANY MANNER WITHOUT THE EXPRESS WRITTEN CONSENT OF SAMTEC, INC.

DO NOT SCALE DRAWING

SHEET SCALE: 1.5:1

samtec

520 PARK EAST BLVD, NEW ALBANY, IN 47150
PHONE: 812-944-6733 FAX: 812-948-5047
e-Mail: info@SAMTEC.com code: 55322

DESCRIPTION:
SMA STR JACK BULKHEAD, RG174 & RG316- 50 OHM

DWG. NO. SMA-J-C-X-ST-BH1-X

BY: R MUSSER 01/14/2008 SHEET 3 OF 3