



SPECIFICATION SHEET

SPECIFICATION SHEET NO.	R0308-BZT52B39S002WT	
DATE	March 08, 2024	
REVISION	A0	Updated With Most Recent Data - Official First Release
DESCRIPTION AND MAIN PARAMETRICS	<p>Small Signals Zener Diodes, BZT52B series, Case SOD-123 BZT52B39 Type, 2 Pads Voltage - Zener (Nom.) (Vz): 39V, Peak Pulse Power: 500mW Max. Junction Temperature. Range 150°C Package in Tape/Reel, 3000pcs/Reel RoHS III/REACH Compliant and Halogen Free (HF)</p>	
CUSTOMER		
CUSTOMER PART NO.		
CROSS REF. PART NO.		
ORIGINAL MFG/PART NO.	MDD/BZT52B39	
PART CODE	BZT52B39S002WT	

VENDOR APPROVE
Issued/Checked/Approved <div style="display: flex; justify-content: space-around; margin-top: 10px;">    </div>
DATE: March 08, 2024

CUSTOMER APPROVE
DATE:

SMD ZENER DIODES BZT52B SERIES CASE SOD-123

MAIN FEATURE

- Small Signal Zener Diodes
- SOD-123 Plastic-Encapsulate Diodes
- Total power dissipation: Max. 500mW.
- Planar die construction
- General purpose and medium current
- Wide Zener reverse voltage range 2.0V to 75V.
- Small plastic package suitable for surface mounted design.
- Tolerance approximately $\pm 2\%$
- REACH/RoHS III Complaint and Halogen Free
- Cross Main Competitor Parts in Market



APPLICATION

- For SMD application

RFQ

[Request For Quotation](#)

PART CODE GUIDE

BZT52B	39	S00	2WT
1	2	3	4

1. BZT52B: Series Code. Small Signals Zener Diodes, BZT52B series, Case SOD-123, BZT52B
2. 39: Specification code for Voltage - Zener (Nom) (Vz): 39V,
3. S00: Internal Control Code, Custom letter A~Z, a-z or digits (0-9)
4. 2WT: Marking code for “2WT” on the case surface, Different Marking for different specification

ELECTRICAL CHARACTERISTICS

See Page 4 ~ Page 6 For Different Part Code

HOW TO ORDER

Please indicate pat code and send us your RFQ by E-mail

SMD ZENER DIODES BZT52B SERIES CASE SOD-123

DIMENSION - Unit: Inch/mm

Image for reference



Marking: Standard

* See Marking Code List at
Page 5~ Page 6

Case Dimension:
SOD-123

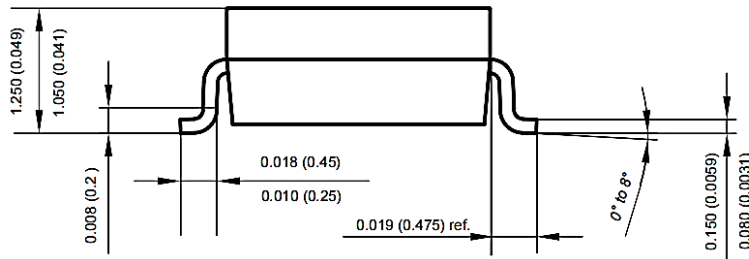
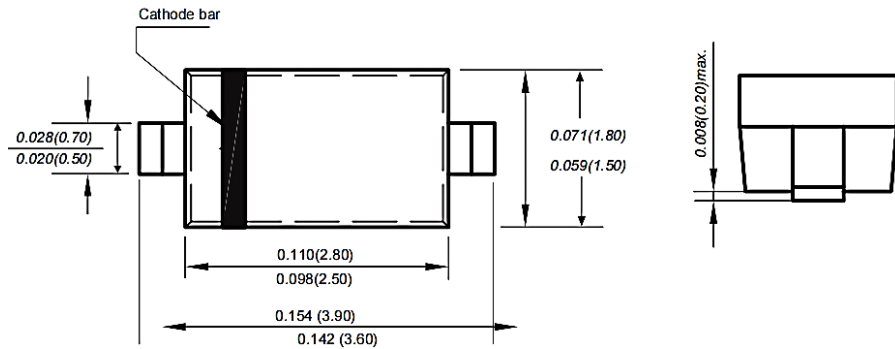

**Recommend
Pad Layout**

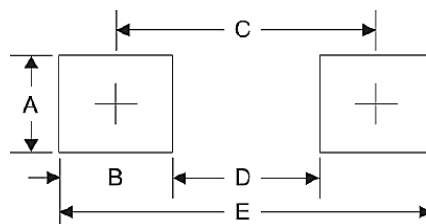

Symbol	Unit (Inch)	Unit (mm)
A	0.047	1.20
B	0.047	1.20
C	0.126	3.20
D	0.079	2.00
E	0.173	4.40

SMD ZENER DIODES BZT52B SERIES CASE SOD-123
MECHANICAL DATA

Case	Terminals	Polarity	Mounting Position	Marking	Weight per piece
JEDEC SOD-123	Solderable per	Polarity symbol	ANY	See Marking	0.00056 ounce
molded plastic	MIL-STD-750,	marking on body		Code List	0.0016 grams
body	Method 2026			(Page 5~Page 6)	

MAX. RATING & CHARACTERISTICS - Ratings at 25°C Ambient Temperature Unless Otherwise Specified.

Parameter	SYMBOLS	VALUE	UNITS
Forward Voltage @ I _F =10mA (Note 2)	V _F	0.9	V
Peak Pulse Power Dissipation	P _D	500	mW
Typical Thermal Resistance From Junction To Ambient (Note 1)	R _{θJA}	340	°C/W
Operating Junction Temperature Range	T _J	+150	°C
Storage Temperature Range	T _{stg}	-55 ~ +150	°C

Notes

1. Thermal Resistance From Junction To Ambient at P.C.B. Mounted With 2.0" X 2.0" (5 X 5 cm) Copper Areas Pads.
2. Short duration test pulse used to minimize self-heating effect
3. f = 1kHz

SMD ZENER DIODES BZT52B SERIES CASE SOD-123
ELECTRICAL CHARACTERISTICS UNIDIRECTIONAL TYPE - Ta = 25°C

Part Code	Zener Voltage Range (See Note 1) V _{ZT} @ I _{ZT} (V)			Test Current I _{ZT} (mA)	Dynamic Impedance Max. Z _{ZT} @ I _{ZT} (Ω)	Reverse Current		Marking Code
	Min.	Nom	Max.			Max. I _R (μA)	@ V _R (V)	
BZT52B2V0S02WY	1.96	2	2.04	5	100	120	0.5	2WY
BZT52B2V2S02WZ	2.16	2.2	2.24	5	100	120	0.7	2WZ
BZT52B2V4S02WX	2.35	2.4	2.45	5	100	120	1	2WX
BZT52B2V7S02W1	2.65	2.7	2.75	5	110	120	1	2W1
BZT52B3V0S02W2	2.94	3	3.06	5	120	50	1	2W2
BZT52B3V3S02W3	3.23	3.3	3.37	5	130	20	1	2W3
BZT52B3V6S02W4	3.53	3.6	3.67	5	130	10	1	2W4
BZT52B3V9S02W5	3.82	3.9	3.98	5	130	5	1	2W5
BZT52B4V3S02W6	4.21	4.3	4.39	5	130	5	1	2W6
BZT52B4V7S02W7	4.61	4.7	4.79	5	130	2	1	2W7
BZT52B5V1S02W8	5	5.1	5.2	5	130	2	1.5	2W8
BZT52B5V6S02W9	5.49	5.6	5.71	5	80	1	2.5	2W9
BZT52B6V2S02WA	6.08	6.2	6.32	5	50	1	3	2WA
BZT52B6V8S02WB	6.66	6.8	6.94	5	30	0.5	3.5	2WB
BZT52B7V5S02WC	7.35	7.5	7.65	5	30	0.5	4	2WC
BZT52B8V2S02WD	8.04	8.2	8.36	5	30	0.5	5	2WD
BZT52B9V1S02WE	8.92	9.1	9.28	5	30	0.5	6	2WE
BZT52B10S002WF	9.8	10	10.2	5	30	0.1	7	2WF
BZT52B11S002WG	10.78	11	11.22	5	30	0.1	8	2WG
BZT52B12S002WH	11.76	12	12.24	5	35	0.1	9	2WH
BZT52B13S002WI	12.74	13	13.26	5	35	0.1	10	2WI

SMD ZENER DIODES BZT52B SERIES CASE SOD-123
ELECTRICAL CHARACTERISTICS UNIDIRECTIONAL TYPE - Ta = 25°C

Part Code	Zener Voltage Range (See Note 1) V _{ZT} @ I _{ZT} (V)			Test Current I _{ZT} (mA)	Dynamic Impedance Max. Z _{ZT} @ I _{ZT} (Ω)	Reverse Current		Marking Code
	Min.	Nom	Max.			Max. I _R (μA)	@ V _R (V)	
BZT52B15S002WJ	14.7	15	15.3	5	40	0.1	11	2WJ
BZT52B16S002WK	15.68	16	16.32	5	40	0.1	12	2WK
BZT52B18S002WL	17.64	18	18.36	5	45	0.1	13	2WL
BZT52B20S002WM	19.6	20	20.4	5	50	0.1	15	2WM
BZT52B22S002WN	21.56	22	22.44	5	55	0.1	17	2WN
BZT52B24S002WO	23.52	24	24.48	5	60	0.1	19	2WO
BZT52B27S002WP	26.46	27	27.54	5	70	0.1	21	2WP
BZT52B30S002WQ	29.4	30	30.6	5	80	0.1	23	2WQ
BZT52B33S002WR	32.34	33	33.66	5	80	0.1	25	2WR
BZT52B36S002WS	35.28	36	36.72	5	90	0.1	27	2WS
BZT52B39S002WT	38.22	39	39.78	2.5	100	2.0	30	2WT
BZT52B43S002WU	42.14	43	43.86	2.5	130	2.0	33	2WU
BZT52B47S002WV	46.06	47	47.94	2.5	150	2.0	36	2WV
BZT52B51S002WW	49.98	51	52.02	2.5	180	1.0	39	2WW
BZT52B56S002X1	54.88	56	57.12	2.5	180	1.0	43	2X1
BZT52B62S002X2	60.76	62	63.24	2.5	200	0.2	47	2X2
BZT52B68S002X3	66.64	68	69.36	2.5	250	0.2	52	2X3
BZT52B75S002X4	73.5	75	76.5	2.5	300	0.2	57	2X4

Notes 1: V_{ZT} is tested with pulses (20 ms)

SMD ZENER DIODES BZT52B SERIES CASE SOD-123

RATINGS AND CHARACTERISTIC CURVES (For Reference Only) - $T_a = 25^\circ\text{C}$ Unless Otherwise Specified

Figure 1. Forward characteristics

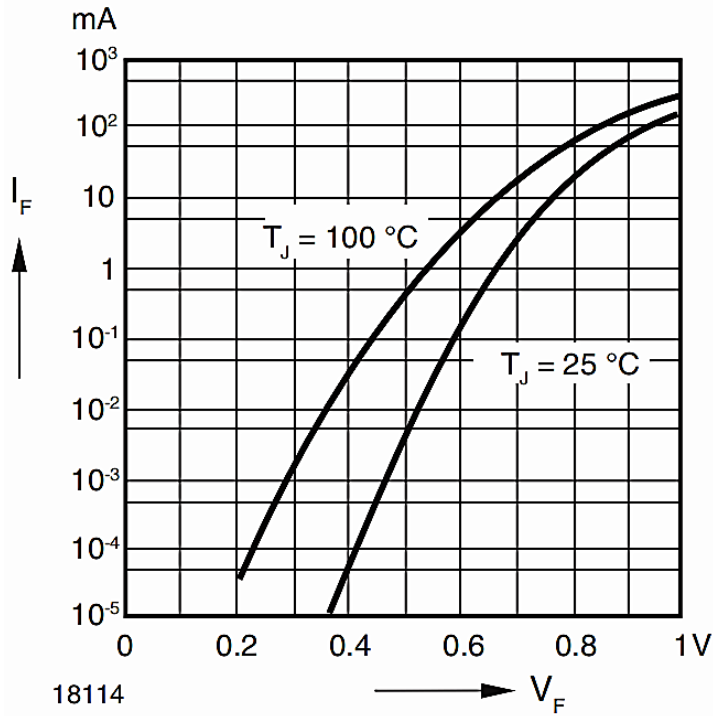
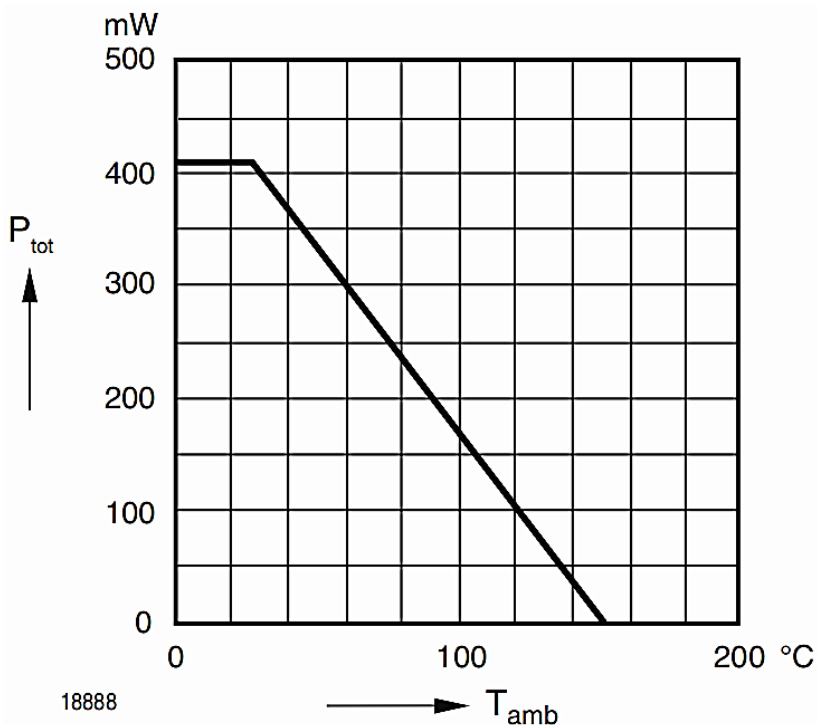

Figure 2. Admissible Power Dissipation vs. Ambient Temperature



SMD ZENER DIODES BZT52B SERIES CASE SOD-123

RATINGS AND CHARACTERISTIC CURVES (For Reference Only) - $T_a = 25^\circ\text{C}$ Unless Otherwise Specified

Figure 3. Dynamic Resistance vs. Zener Current

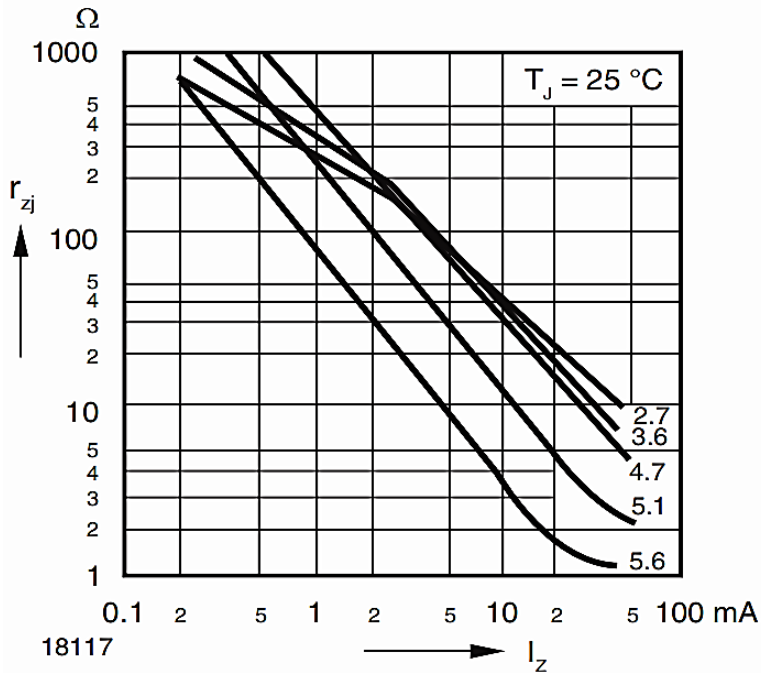
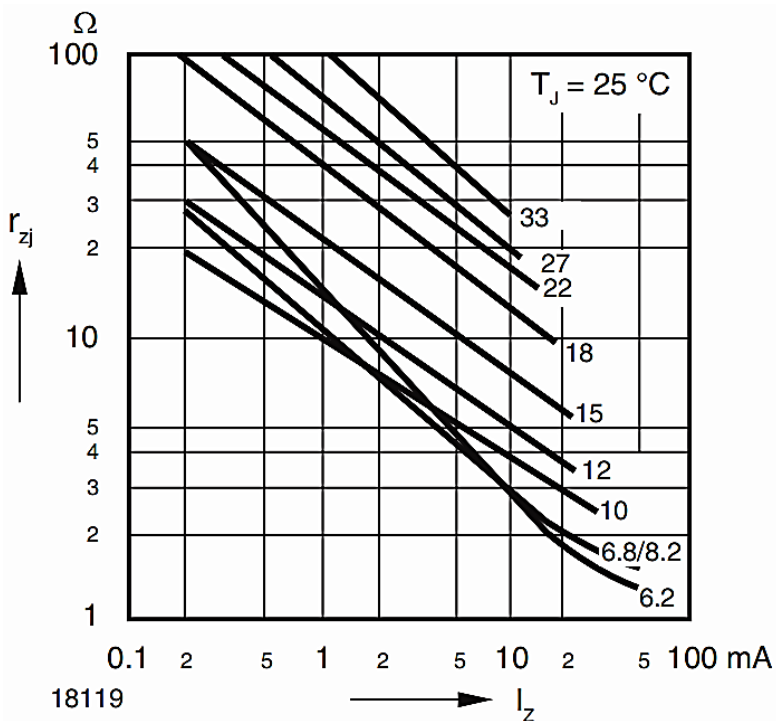

Figure 4. Dynamic Resistance vs. Zener Current



SMD ZENER DIODES BZT52B SERIES CASE SOD-123

RATINGS AND CHARACTERISTIC CURVES (For Reference Only) - Ta= 25°C Unless Otherwise Specified

Figure 5. Dynamic Resistance vs. Zener Current

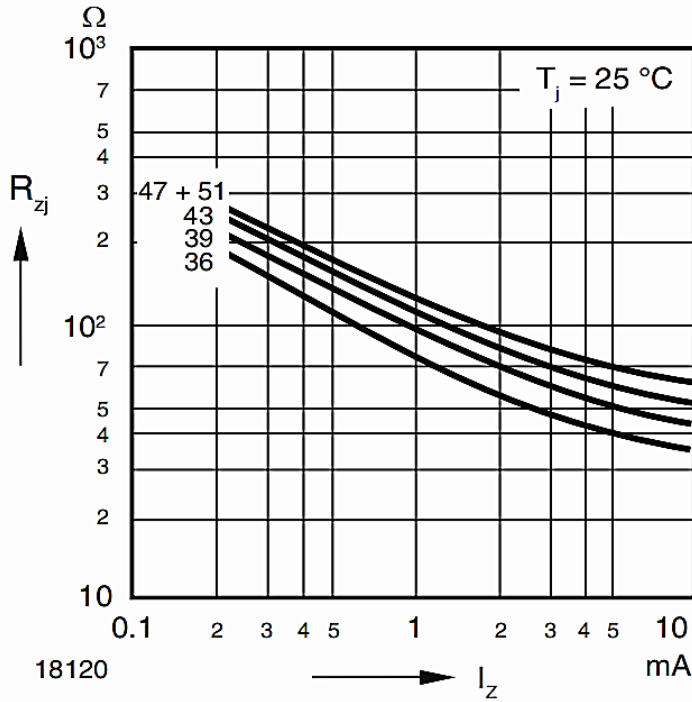
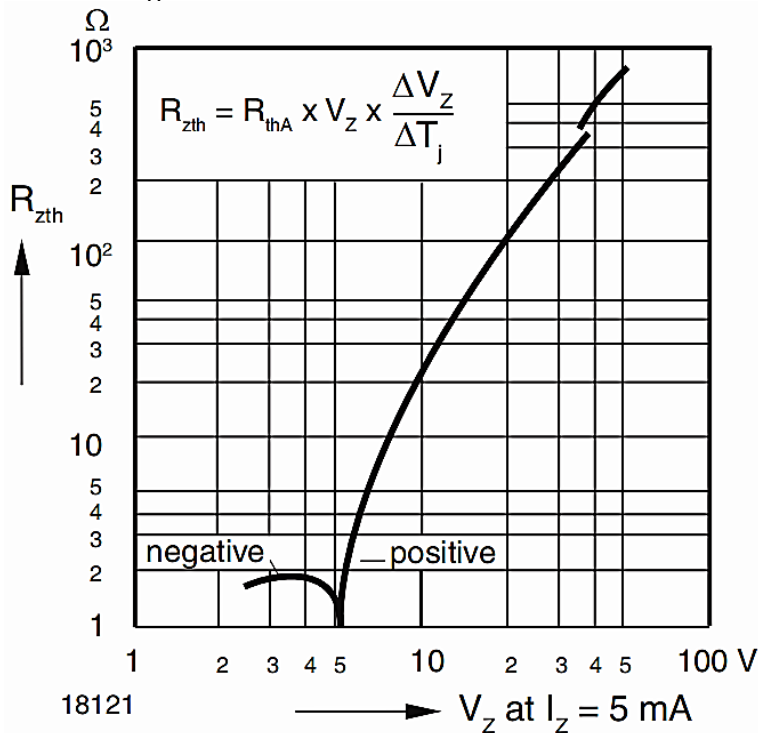

Figure 6. Thermal Differential Resistance vs. Zener Voltage



SMD ZENER DIODES BZT52B SERIES CASE SOD-123

RATINGS AND CHARACTERISTIC CURVES (For Reference Only) - Ta= 25°C Unless Otherwise Specified

Figure 7. Dynamic Resistance vs. Zener Current

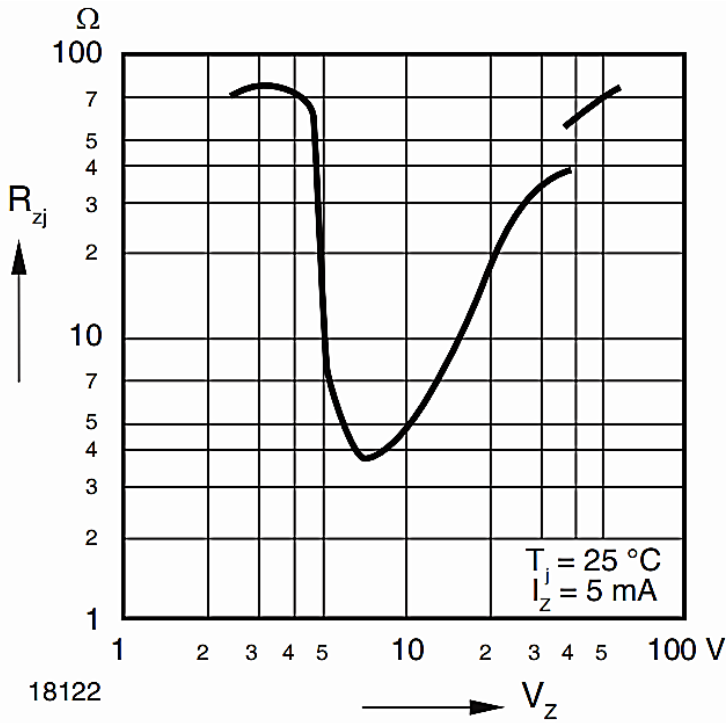
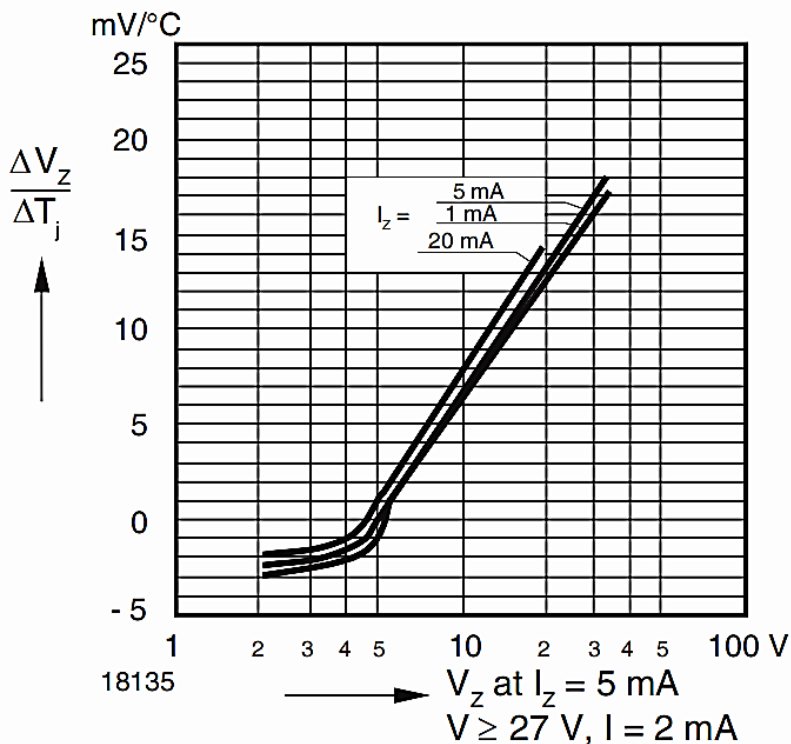

Figure 8. Temperature Dependence of Zener Voltage vs. Zener Voltage



SMD ZENER DIODES BZT52B SERIES CASE SOD-123

RATINGS AND CHARACTERISTIC CURVES (For Reference Only) - Ta= 25°C Unless Otherwise Specified

Figure 9. Change of Zener Voltage vs. Junction Temperature

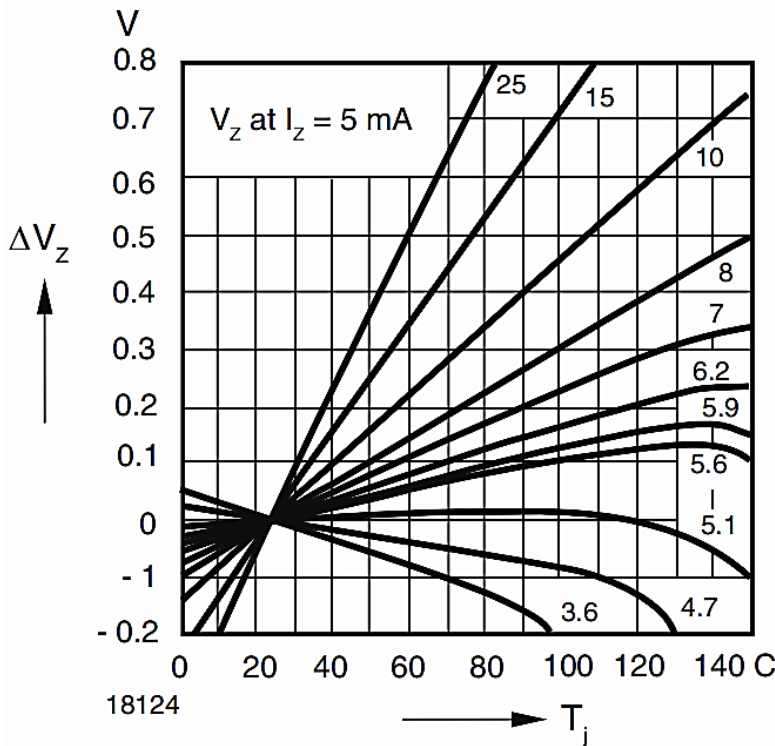
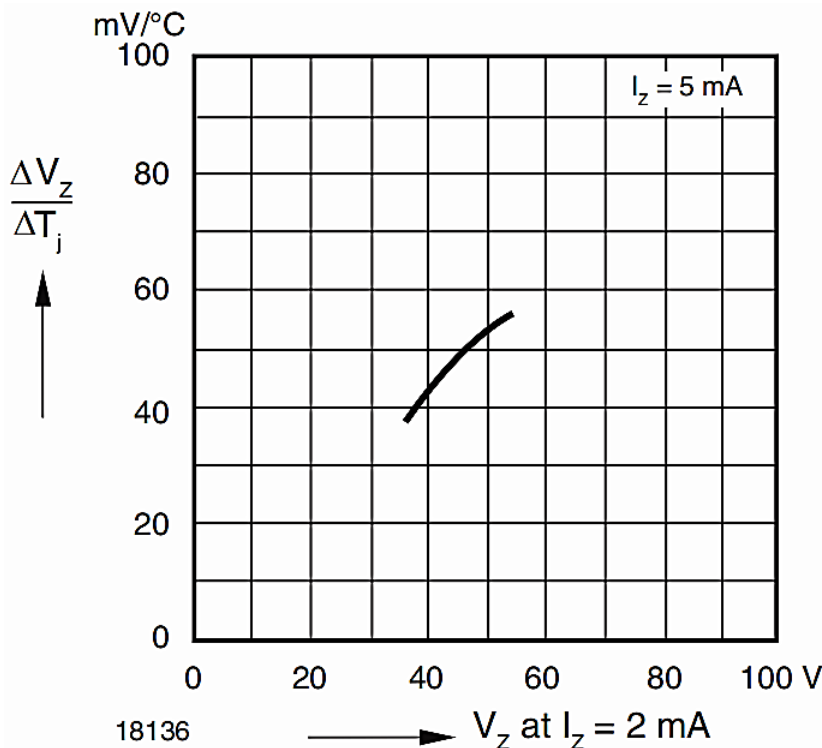

Figure 10. Temperature Dependence of Zener Voltage vs. Zener Voltage



SMD ZENER DIODES BZT52B SERIES CASE SOD-123

RATINGS AND CHARACTERISTIC CURVES (For Reference Only) - $T_a = 25^\circ\text{C}$ Unless Otherwise Specified

Figure 11. Change of Zener Voltage vs. Junction Temperature

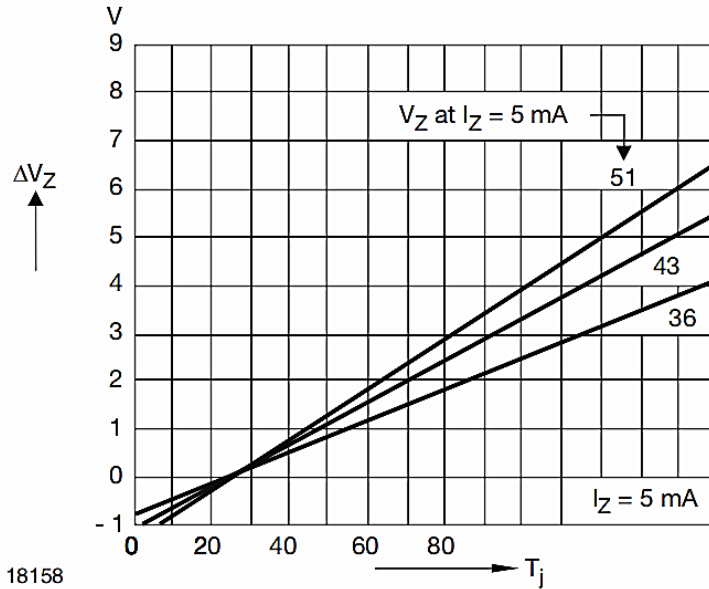
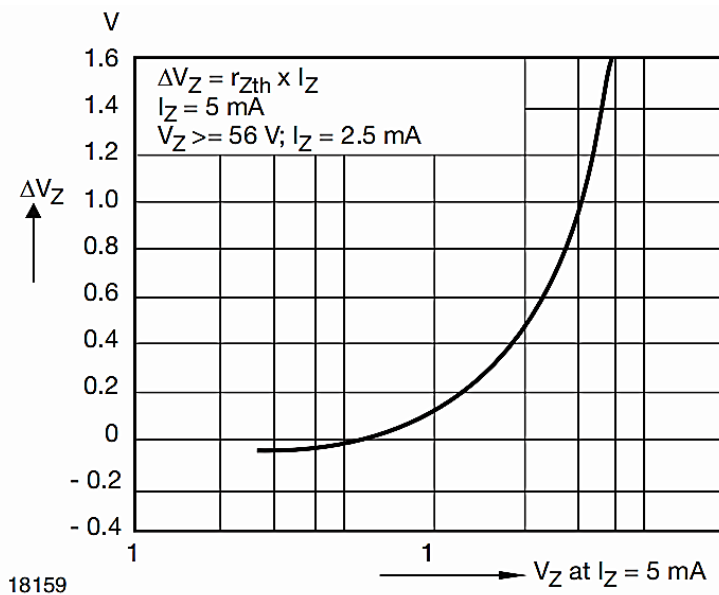

Figure 12. Change of Zener Voltage from Turn-on up to the Point of Thermal Equilibrium vs. Zener Voltage



SMD ZENER DIODES BZT52B SERIES CASE SOD-123

RATINGS AND CHARACTERISTIC CURVES (For Reference Only) - Ta= 25°C Unless Otherwise Specified

Figure 13. Change of Zener Voltage from Turn-on up to the Point of Thermal Equilibrium vs. Zener Voltage

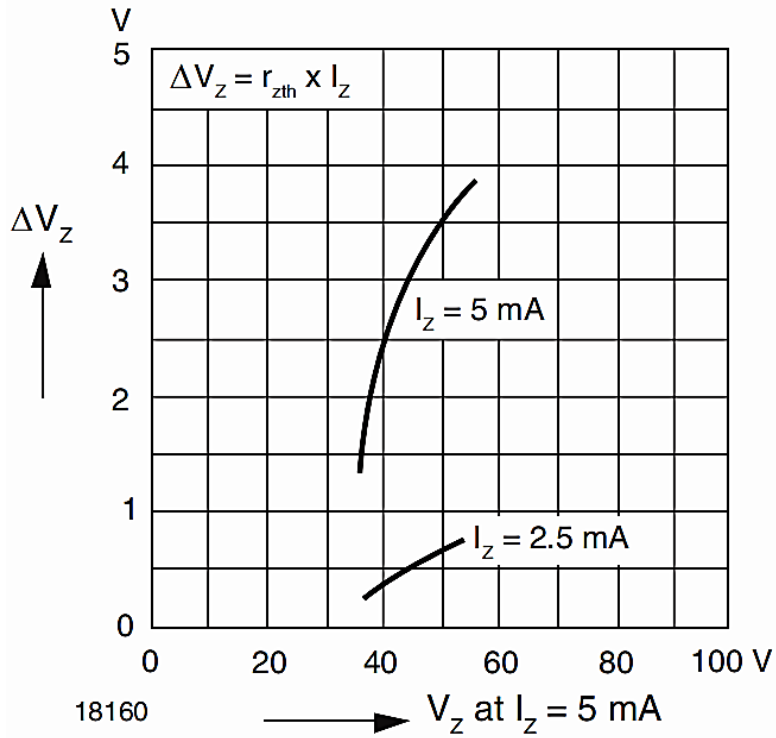
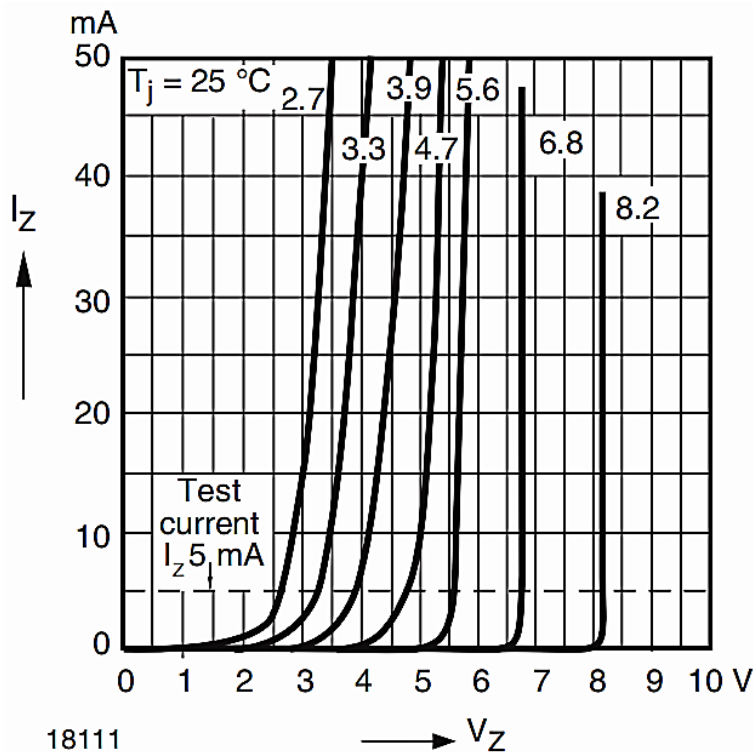

Figure 14. Breakdown Characteristics



SMD ZENER DIODES BZT52B SERIES CASE SOD-123

RATINGS AND CHARACTERISTIC CURVES (For Reference Only) - $T_a = 25^\circ\text{C}$ Unless Otherwise Specified

Figure 15. Breakdown Characteristics

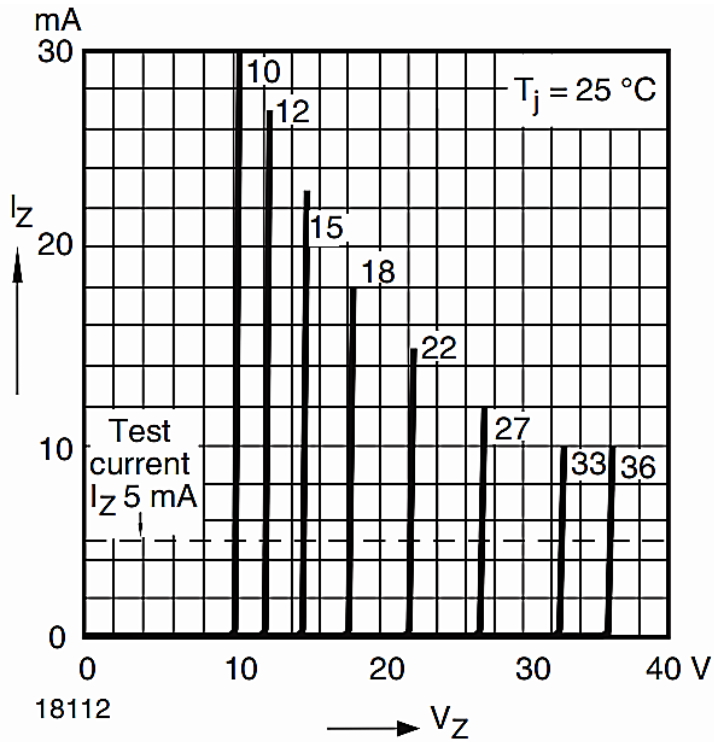
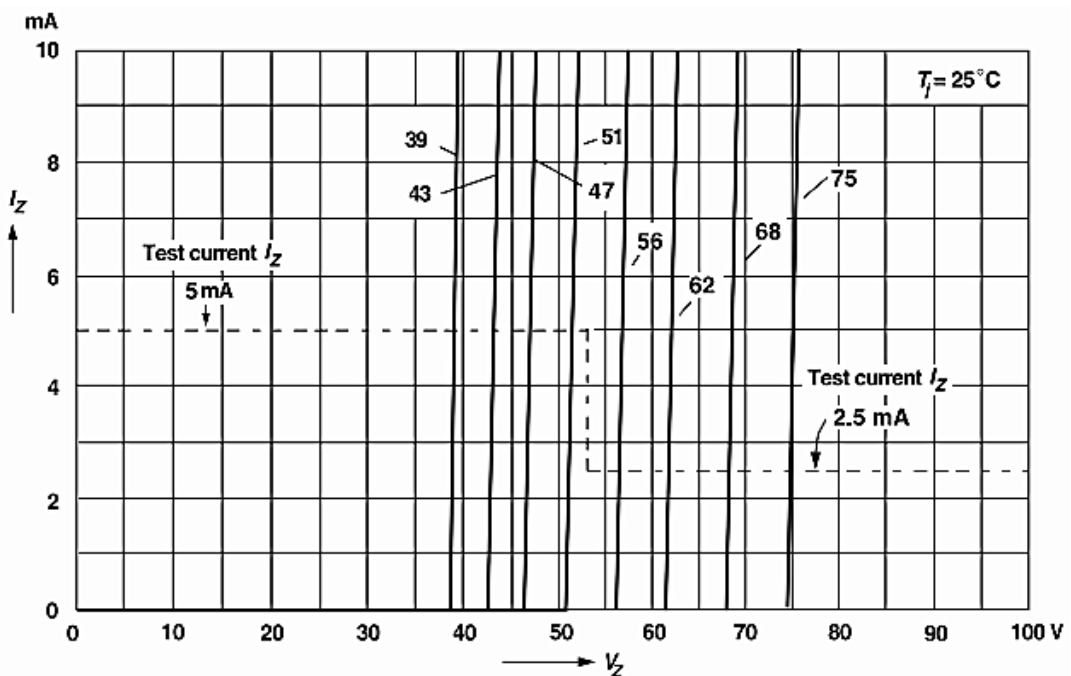

Figure 16. Breakdown Characteristics



18157

SMD ZENER DIODES BZT52B SERIES CASE SOD-123
RELIABILITY- For Reference only

NUMBER	EXPERIMENT ITEMS	EXPERIMENT METHOD AND CONDITIONS	REFERENCE DOCUMENTS
1	Solder Resistance Test	Test 260°C± 5°C for 10 ± 2 sec. Immerse body into solder 1/16" ± 1/32"	MIL-STD-750D METHOD-2031.2
2	Solderability Test	230°C ±5°C for 5 sec.	MIL-STD-750D METHOD-2026.1 0
3	Pull Test	1 kg in axial lead direction for 10 sec.	MIL-STD-750D METHOD-2036.4
4	Bend Test	0.5Kg Weight Applied To Each Lead, Bending Arcs 90 °C ± 5 °C For 3 Times	MIL-STD-750D METHOD-2036.4
5	High Temperature Reverse Bias Test	TA=100°C for 1000 Hours at VR=80% Rated VR	MIL-STD-750D METHOD-1038.4
6	Forward Operation Life Test	TA=25°C Rated Average Rectified Current	MIL-STD-750D METHOD-1027.3
7	Intermittent Operation Life Test	On state: 5 min with rated IRMS Power Off state: 5 min with Cool Forced Air. On and off for 1000 cycles.	MIL-STD-750D METHOD-1036.3
8	Pressure Cooker Test	15 PSIG, TA=121°C, 4 hours	MIL-S-19500 APPENOIXC
9	Temperature Cycling Test	-55°C~+125°C; 30 Minutes For Dwelled Time 5 minutes for transferred time. Total: 10 cycles.	MIL-STD-750D METHOD-1051.7
10	Thermal Shock Test	0°C for 5 minutes., 100°C for 5minutes, Total: 10 cycles	MIL-STD-750D METHOD-1056.7
11	Forward Surge Test	8.3ms Single Sale Sine-wave One Surge.	MIL-STD-750D METHOD-4066.4
12	Humidity Test	TA=65°C, RH=98% for 1000 hours.	MIL-STD-750D METHOD-1021.3
13	High Temperature Storage life Test	150°C for 1000 Hours	MIL-STD-750D METHOD-1031.5

SMD ZENER DIODES BZT52B SERIES CASE SOD-123

SUGGESTED REFLOW PROFILE - For Reference Only

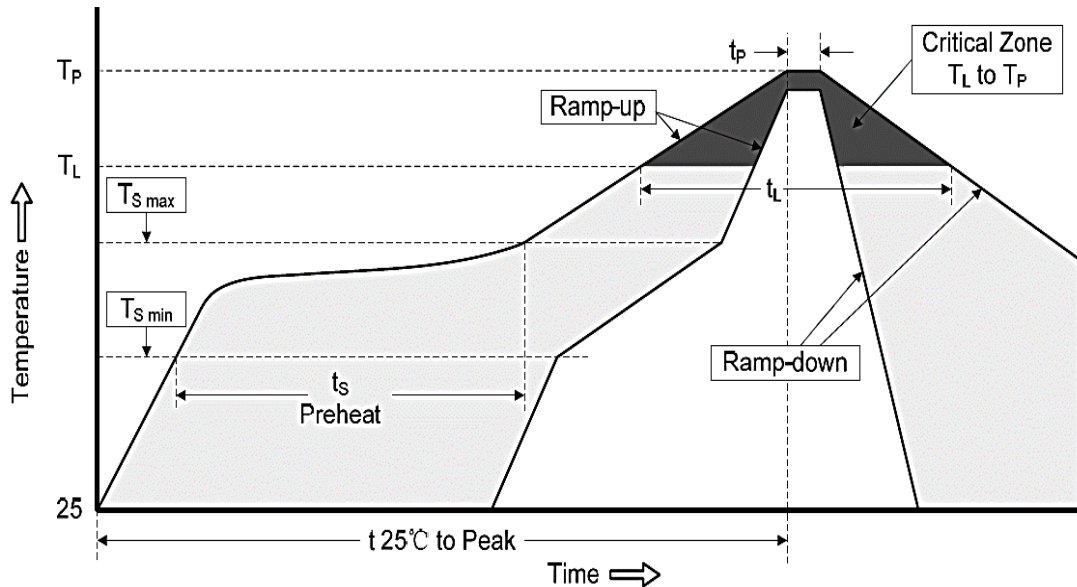

PROFILE FEATURE		PB-FREE ASSEMBLY
Average Ramp-up Rate (Ts Max to Tp)		3°C/second Max
Preheat	Temperature Min (Ts Min.)	150°C
	Temperature Max (Ts Max.)	200°C
	Time (ts Min. to ts Max.)	60 ~ 180 seconds
Time maintained above	Temperature (Tl)	217°C
	Time (tl)	60 ~ 150 seconds
Peak/Classification Temperature (Tp)		260 °C
Time within 5°C of actual Peak Temperature (tp)		20 ~ 40 seconds
Ramp-down rate		6 °C /Second Max.
Time 25 °C to Peak Temperature		8 minutes Max.
Suggest reflow times		3 Times Max.

SMD ZENER DIODES BZT52B SERIES CASE SOD-123
TAPE/REEL, 3000pcs/Reel (Unit: mm)

All Devices are packed in accordance with EIA standard RS-481-A and Tape wide 8mm, Component Spacing 4.0mm

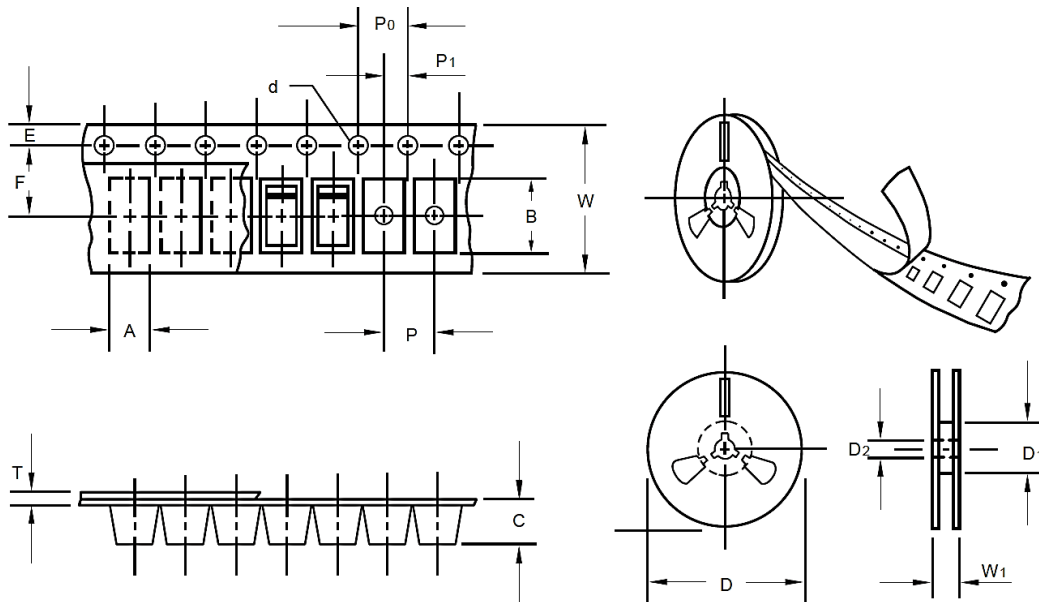

ITEM	SYMBOL	TOLERANCE	CASE SOD-123
Carrier width	A	0.1	2.10
Carrier Length	B	0.1	4.00
Carrier Depth	C	0.1	1.60
Sprocket hole	d	0.05	1.55
13"Reel outside diameter	-	-	-
13"Reel inner diameter	-	-	-
7"Reel outside diameter	D	2.0	178.00
7"Reel inner diameter	D1	Min.	50.00
Feed hole diameter	D2	0.5	13.00
Sprocket hole position	E	0.1	1.75
Punch hole position	F	0.1	3.50
Punch hole pitch	P	0.1	4.00
Sprocket hole pitch	P0	0.1	4.00
Embossment center	P1	0.1	2.00
Overall tape thickness	T	0.1	0.25
Tape width	W	0.3	8.15
Reel width	W1	1.0	10.50

SMD ZENER DIODES BZT52B SERIES CASE SOD-123

ROHS COMPLIANCE

- The levels of RoHS restricted materials in this product are below the maximum concentration values (also referred to as the threshold limits) permitted for such substances, or are used in an exempted application, in accordance with EU RoHS Directive (EU) 2015/863 EC (RoHS3). RoHS Test Report for this product can be obtained can be obtained at Download Center.

REACH COMPLIANCE

- REACH substances of high concern (SVHCs) information is available for this product. Since the European Chemical Agency (ECHA) has published notice of their intent to frequently revise the SVHC listing for the foreseeable future, REACH Test Report for this product can be obtained can be obtained at Download Center.

IMPORTANT NOTES AND DISCLAIMER

1. All Product parametric performance is indicated in the Electrical Characteristics for the listed herein test conditions, unless otherwise noted. Product performance may not be indicated by the Electrical Characteristics if operated under different conditions.
2. NextGen Component, Inc (*NextGen*) reserves the right to make changes to this document and its products and specifications at any time without notice. Customers should obtain and confirm the latest product information and specifications before final design, purchase or use.
3. *NextGen* makes no warranty, representation or guarantee regarding the suitability of its products for any particular purpose, not does NextGen assume any liability for application assistance or customer product design.
4. *NextGen* does not warrant or accept any liability with products which are purchased or used for any unintended or unauthorized application. No license is granted by implication or otherwise under any intellectual property rights of NextGen.
5. *NextGen* products are not authorized for use as critical components in life support devices or systems without express written approval by *NextGen*.
6. *NextGen* requires that customers first obtain an RMA (Returned Merchandise Authorization) number prior to returning any products. Returns must be made within 30 days of the date of invoice, be in the original packaging, unused and like-new condition. At the time of quoting or purchasing, a product may say that it is Non-Cancelable/ Non-Returnable (NCNR). These products are not returnable and not refundable.