

QSFP-DD 400G Loopback Module

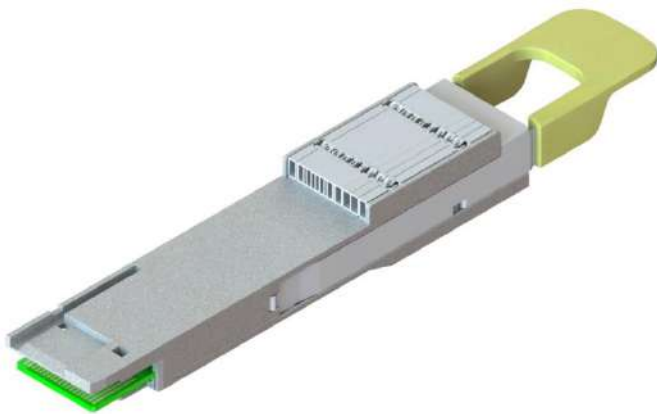

0-Watt

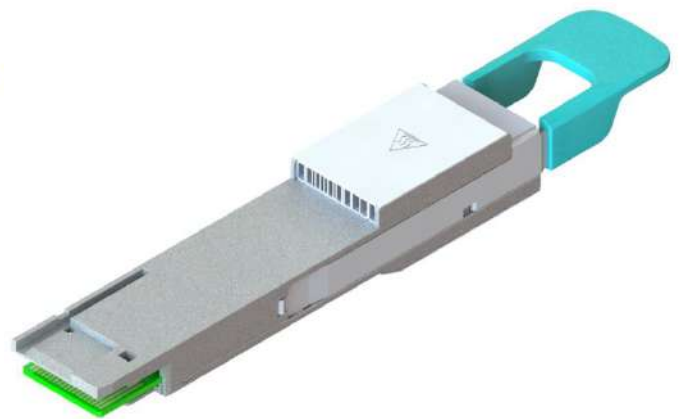

14-Watt

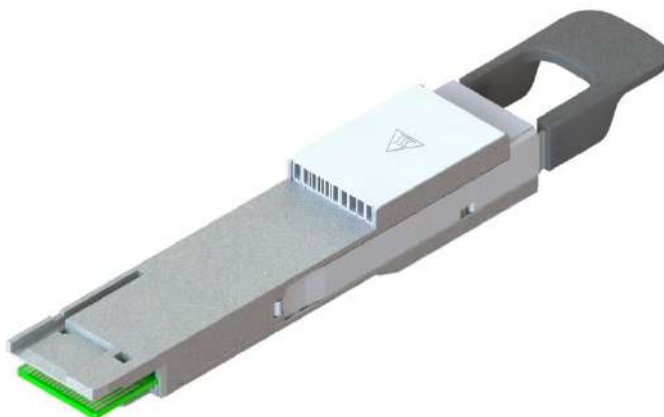

16-Watt

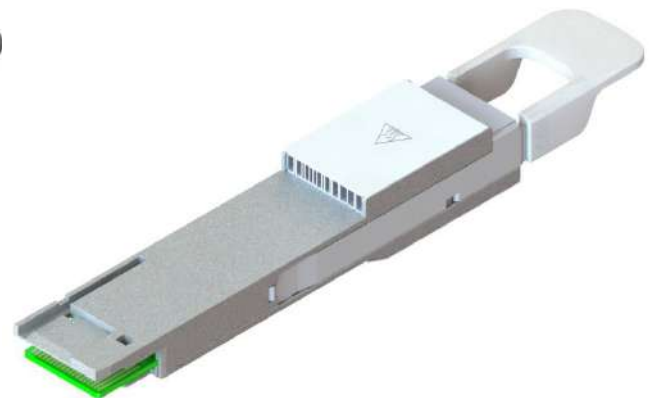

20-Watt

Features

- ◆ Industry's highest rated mating cycles for 2000 and above
- ◆ Built-in surge current mitigation technology
- ◆ Adjustable power consumption up to evenly distributed to the 3 regions, each region is individually
- ◆ Operating temperature: -40°C to 85°C
- ◆ +3.3V power supply
- ◆ Supports 8*10G/25G/56G PAM4 data rates
- ◆ 2-wire interface for integrated Digital Diagnostic Monitoring
- ◆ Signal integrity performance meets IEEE 802.3ba, 802.3bj , 802.3cd standards respectively
- ◆ Enhanced heat dissipation technology for high power testing
- ◆ Custom EEPROM available
- ◆ A multi-color LED indicator for high/low power modes
- ◆ Hot-pluggable
- ◆ RoHS 2.0 compliant

Application

- ◆ QSFP-DD port/system testing
- ◆ Ethernet IEEE 802.3 (Gigabit, 10 Gigabit and 25 Gigabit Ethernet)
- ◆ SONET, SDH, GBE, Fiber Channel Support

Standard

- ◆ Common Management Interface Specification, Rev 4.0
- ◆ QSFP-DD/QSFP-DD800/QSFP112 Hardware Specification, Rev 6.01
- ◆ IEEE Std 802.3cd
- ◆ IEEE 802.3bj
- ◆ SFF-8024, SFF Cross Reference to Industry Products, Rev 4.7

Description

Designed and engineered to accommodate customers high usage 2000 cycles at -40°C to 85°C, the loopback module series are the most reliable products in the market to enable the quickest customers systems production and deployment. Software defined multiple power consumption may emulate the optical module power, and the embedded insertion loss characteristics emulates the real-world cabling for

200G/400G Ethernet/Infiniband/FC. The built-in surge current mitigation technology mitigates the DUT risks from being damaged. The broad operating temperature range accommodates the enterprise, datacom and telecom applications. The loopback module may be used for ports testing, field deployment testing and equipment troubleshooting.

Specification

Absolute Maximum Ratings				
Parameter	Symbol	Min	Max	Unit
Storage Temperature	T _s	-40	+85	°C
Ambient Operating Temperature	T _a	-40	+85	°C
Storage Relative Humidity	RH _s	0	95	%
Operating Relative Humidity	RH _o	0	85	%
Power Supply Voltage	V _{cc}	2.97	+3.63	V

Recommended Operating Conditions					
Parameter	Symbol	Min	Typical	Max	Unit
Ambient Operating Temperature	T _a	-40	-	+85	°C
Power Supply Voltage	V _{cc}	2.97	3.3	3.63	V
Data Rate	BRate	0.1	-	400	Gbps
Durability Cycles		-	2000	2250	Times

High Speed Characteristics						
Parameter	Symbol	Min	Typical	Max	Unit	Notes
Input/Output Impedance	Z _d	90	100	110	Ohm	Differential Impedance
Return Loss	SDD11/22	IEEE 802.3bj CL92.10.3.			dB	At Nyquist Frequency
Insertion Loss	SDD21	0.845	-	6.615	dB	Exclude the MCB insertion loss, at 13GHz
Insertion Loss Deviation	ILD	-1		1		At Nyquist Frequency
Skew between lanes	SKEW			200	ps	

Pin Definition

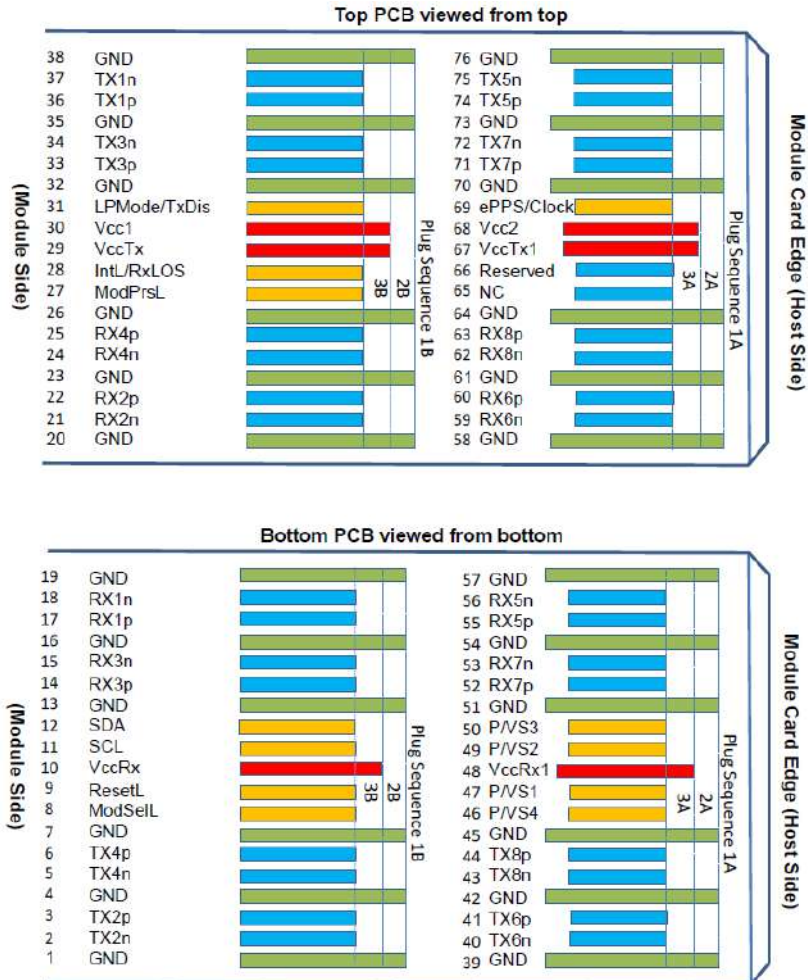

Table 1- Pad Function Definition

Pad	Logic	Symbol	Description	Plug Sequence ⁴	Notes
1		GND	Ground	1B	1
2	CML-I	Tx2n	Transmitter Inverted Data Input	3B	
3	CML-I	Tx2p	Transmitter Non-Inverted Data Input	3B	
4		GND	Ground	1B	1
5	CML-I	Tx4n	Transmitter Inverted Data Input	3B	
6	CML-I	Tx4p	Transmitter Non-Inverted Data Input	3B	
7		GND	Ground	1B	1
8	LVTTL-I	ModSelL	Module Select	3B	
9	LVTTL-I	ResetL	Module Reset	3B	
10		VccRx	+3.3V Power Supply Receiver	2B	2
11	LVC MOS-I/O	SCL	TWI serial interface clock	3B	
12	LVC MOS-I/O	SDA	TWI serial interface data	3B	
13		GND	Ground	1B	1
14	CML-O	Rx3p	Receiver Non-Inverted Data Output	3B	
15	CML-O	Rx3n	Receiver Inverted Data Output	3B	
16		GND	Ground	1B	1
17	CML-O	Rx1p	Receiver Non-Inverted Data Output	3B	
18	CML-O	Rx1n	Receiver Inverted Data Output	3B	
19		GND	Ground	1B	1
20		GND	Ground	1B	1
21	CML-O	Rx2n	Receiver Inverted Data Output	3B	
22	CML-O	Rx2p	Receiver Non-Inverted Data Output	3B	
23		GND	Ground	1B	1
24	CML-O	Rx4n	Receiver Inverted Data Output	3B	
25	CML-O	Rx4p	Receiver Non-Inverted Data Output	3B	
26		GND	Ground	1B	1
27	LVTTL-O	ModPrsL	Module Present	3B	
28	LVTTL-O	IntL/RxLOS	Interrupt/optional RxLOS	3B	
29		VccTx	+3.3V Power supply transmitter	2B	2
30		Vcc1	+3.3V Power supply	2B	2
31	LVTTL-I	LPMode/TxDis	Low Power mode/optional TX Disable	3B	
32		GND	Ground	1B	1
33	CML-I	Tx3p	Transmitter Non-Inverted Data Input	3B	
34	CML-I	Tx3n	Transmitter Inverted Data Input	3B	
35		GND	Ground	1B	1
36	CML-I	Tx1p	Transmitter Non-Inverted Data Input	3B	
37	CML-I	Tx1n	Transmitter Inverted Data Input	3B	
38		GND	Ground	1B	1
39		GND	Ground	1A	1
40	CML-I	Tx6n	Transmitter Inverted Data Input	3A	
41	CML-I	Tx6p	Transmitter Non-Inverted Data Input	3A	
42		GND	Ground	1A	1
43	CML-I	Tx8n	Transmitter Inverted Data Input	3A	
44	CML-I	Tx8p	Transmitter Non-Inverted Data Input	3A	
45		GND	Ground	1A	1

Pad	Logic	Symbol	Description	Plug Sequence ⁴	Notes
46	LVC MOS/CML-I	P/VS4	Programmable/Module Vendor Specific 4	3A	5
47	LVC MOS/CML-I	P/VS1	Programmable/Module Vendor Specific 1	3A	5
48		VccRx1	3.3V Power Supply	2A	2
49	LVC MOS/CML-O	P/VS2	Programmable/Module Vendor Specific 2	3A	5
50	LVC MOS/CML-O	P/VS3	Programmable/Module Vendor Specific 3	3A	5
51		GND	Ground	1A	1
52	CML-O	Rx7p	Receiver Non-Inverted Data Output	3A	
53	CML-O	Rx7n	Receiver Inverted Data Output	3A	
54		GND	Ground	1A	1
55	CML-O	Rx5p	Receiver Non-Inverted Data Output	3A	
56	CML-O	Rx5n	Receiver Inverted Data Output	3A	
57		GND	Ground	1A	1
58		GND	Ground	1A	1
59	CML-O	Rx6n	Receiver Inverted Data Output	3A	
60	CML-O	Rx6p	Receiver Non-Inverted Data Output	3A	
61		GND	Ground	1A	1
62	CML-O	Rx8n	Receiver Inverted Data Output	3A	
63	CML-O	Rx8p	Receiver Non-Inverted Data Output	3A	
64		GND	Ground	1A	1
65		NC	No Connect	3A	3
66		Reserved	For future use	3A	3
67		VccTx1	3.3V Power Supply	2A	2
68		Vcc2	3.3V Power Supply	2A	2
69	LVC MOS-I	ePPS/Clock	1PPS PTP clock or reference clock input	3A	6
70		GND	Ground	1A	1
71	CML-I	Tx7p	Transmitter Non-Inverted Data Input	3A	
72	CML-I	Tx7n	Transmitter Inverted Data Input	3A	
73		GND	Ground	1A	1
74	CML-I	Tx5p	Transmitter Non-Inverted Data Input	3A	
75	CML-I	Tx5n	Transmitter Inverted Data Input	3A	
76		GND	Ground	1A	1

Note 1: QSFP-DD uses common ground (GND) for all signals and supply (power). All are common within the QSFP-DD module and all module voltages are referenced to this potential unless otherwise noted. Connect these directly to the host board signal-common ground plane. Each connector Gnd contact is rated for a steady state current of 500 mA.

Note 2: VccRx, VccRx1, Vcc1, Vcc2, VccTx and VccTx1 shall be applied concurrently. Supply requirements defined for the host side of the Host Card Edge Connector are listed in Table 13. For power classes 4 and above the module differential loading of input voltage pads must not result in exceeding contact current limits. Each connector Vcc contact is rated for a steady state current of 1500 mA.

Note 3: Reserved pad recommended to be terminated with 10 kΩ to ground on the host. Pad 65 (No Connect) Shall be left unconnected within the module, optionally pad 65 may get terminated with 10 kΩ to ground on the host.

Note 4: Plug Sequence specifies the mating sequence of the host connector and module. The sequence is 1A, 2A, 3A, 1B, 2B, 3B. (See Figure 2 for pad locations) Contact sequence A will make, then break contact with additional QSFP-DD pads. Sequence 1A and 1B will then occur simultaneously, followed by 2A and 2B, followed by 3A and 3B.

Note 5: Full definitions of the P/VSx signals currently under development. For module designs using programmable/vendor specific inputs P/VS1 and P/VS4 signals it is recommended each to be terminated in the module with 10 kΩ. For host designs using programmable/vendor specific outputs P/VS2 and P/VS3 signals it is recommended each to be terminated on the host with 10 kΩ.

Note 6: for host not implementing ePPS/Clock, it is not necessary to parallel terminate the ePPS/Clock signal to ground on the host. ePPS/Clock already has parallel termination in the module see 4.2.6.

Typical application Circuit

The 16 lanes are connected as following with match polarity:

- TX1 and RX1
- TX2 and RX2
- TX3 and RX3
- TX4 and RX4
- TX5 and RX5
- TX6 and RX6
- TX7 and RX7
- TX8 and RX8

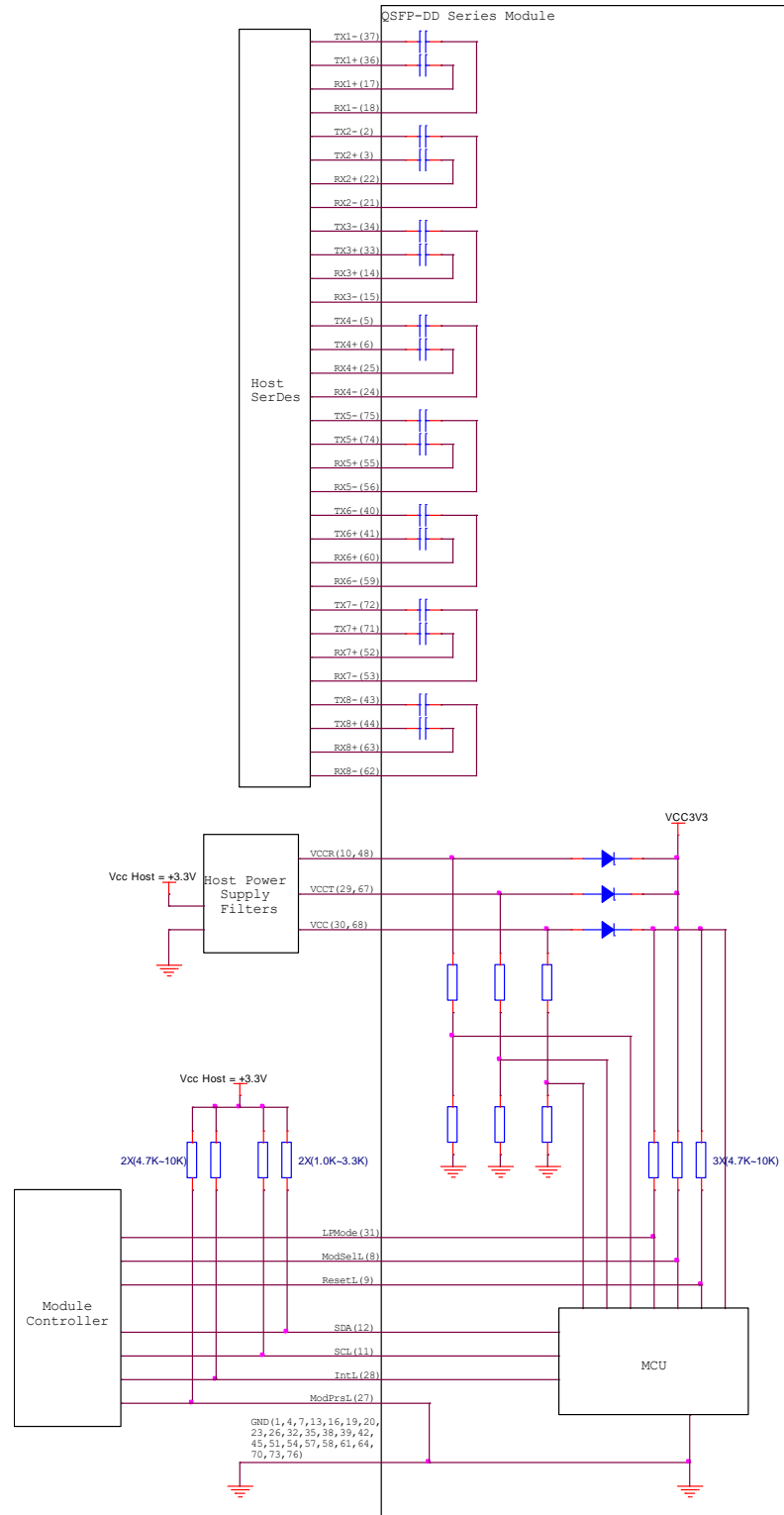

Status LED

A multi-color LED must be viewed from the front of the module in order to signify high/low power modes, as well as interrupts. Low-power mode is defined as device address A0h.00.200.7:4 = 0000b or The InitMode is High.

- **Solid green:** low-power mode
- **Solid red:** high-power mode
- **Blinking green:** low-power mode with any of the interrupt flag is set
- **Blinking red:** high-power mode with any of the interrupt flag is set

I2C interface

Upon the completion of the MgmtInit state, the I2C interface on the module must support Fastmode as defined in the UM10204, I2 C-bus specification and user manual, Rev. 6 – 4 April 2014 in order to handle the SCL clock frequency between 0kHz and 400KHz. In addition, the module may only clock stretching the SCL less than 100 µsec in any frequency.

QSFP-DD Identification:

Table 1: The module must provide the ID in the following registers

Page	Address	Size	Name	Description
N/A	0	1	Identifier	18h: Identifier Type of QSFP-DD
	3	1	Module state	b0000_001x: Module LowPwr state
	85	1	Module Type Encodings	03h: Passive Cu
	86	1	ApSelCode 1: Host Electrical Interface ID	11h: 400GAUI-8 C2M
	87	1	ApSelCode 1: Module Media Interface ID	BFh: Passive Loopback Module
	88	1	ApSel Code 1: Host & Media Lane Count	80h: 8 host lanes and 0 media lanes
	89	1	ApSel Code 1: Host Lane Assignment Options	01h: Begin on Host Lane 1
00h	128	1	Identifier	18h: Identifier Type of QSFP-DD
	129-144	16	Vendor name	Vendor name (ASCII)
	148-163	16	Vendor PN	Part number (ASCII)
	164-165	2	Vendor rev	Revision (ASCII)
	166-181	16	Vendor SN	Vendor Serial Number (ASCII)
	200	1	Maximum Power identifier	bxxxx_001x: 14-Watt loopback bxxxx_00xx: 16-Watt loopback

				bxxxx_10xx: 20-Watt loopback bxxxx_11xx: 0-Watt loopback Refer to address 201
	201	1	Max Power	0x50 (20W/0.25W = 80) 0x40 (16W/0.25W = 64) 0x38 (14W/0.25W = 56) 0x00 (0W, Without Power burner. Only EEPROM)

Case temperature monitor

The case temperature is presented as a 16-bit signed two's complement value in increment of 1/256°C at I2C registers 14(MSB) and 15(LSB) for the top case .

Table 2: Temperature DOM

Page	Address	Size	Name	Description
N/A	14	1	Module Monitor 1: Temperature 1 MSB	Internally measured temperature, top case
	15	1	Module Monitor 1: Temperature 1 LSB	
Page	Address	Bits	Name	Description
N/A	9	3	TempMonLowWarningFlag	Latched Flag for low temperature warning
		2	TempMonHighWarningFlag	Latched Flag for high temperature warning
		1	TempMonLowAlarmFlag	Latched Flag for low temperature alarm
		0	TempMonHighAlarmFlag	Latched Flag for high temperature alarm

Power rail voltage monitor

The 3 VCC power rails, VccRx, VccTx and Vcc are monitored individually.

Table 3: VCC voltage DOM

Page	Address	Size	Name	Description
N/A	16	1	Module Monitor 2: Supply 3.3-volt MSB	Internally measured 3.3 volt input supply voltage VccRx* gold-fingers: in 100µV increments
	17	1	Module Monitor 2: Supply 3.3-volt LSB	
	18	1	Module Monitor 3: Supply 3.3-volt MSB	Internally measured 3.3 volt input supply voltage VccTx* gold-fingers: in 100µV increments
	19	1	Module Monitor 3:	

			Supply 3.3-volt LSB	
	22	1	Module Monitor 5: TEC current MSB	Internally measured 3.3 volt input supply voltage Vcc* gold-fingers: in 100µV increments
	23	1	Module Monitor 5: TEC current MSB	
Page	Address	Bits	Name	Description
N/A	9	7	VccRx MonLowWarningFlag	Latched Flag for low supply VccRx voltage warning
		6	VccRx MonHighWarningFlag	Latched Flag for high supply VccRx voltage warning
		5	VccRx MonLowAlarmFlag	Latched Flag for low supply VccRx voltage alarm
		4	VccRx MonHighAlarmFlag	Latched Flag for high supply VccRx voltage alarm
	10	3	VccTx MonLowWarningFlag	Latched Flag for low supply VccTx voltage warning
		2	VccTx MonHighWarningFlag	Latched Flag for high supply VccTx voltage warning
		1	VccTx MonLowAlarmFlag	Latched Flag for low supply VccTx voltage alarm
		0	VccTx MonHighAlarmFlag	Latched Flag for high supply VccTx voltage alarm
	11	3	Vcc MonLowWarningFlag	Latched Flag for low supply Vcc voltage warning
		2	Vcc MonHighWarningFlag	Latched Flag for high supply Vcc voltage warning
		1	Vcc MonLowAlarmFlag	Latched Flag for low supply Vcc voltage alarm
		0	Vcc MonHighAlarmFlag	Latched Flag for high supply Vcc voltage alarm

Reset requirement

There should be 3 different type of reset in the module, power-up-reset, hard-reset and softreset. All the 3 resets should cause the module to consume default power: less than or equal to 1.5W

Power-up-reset

The power-up-reset should cause all the active components, including the microcontroller, in the module reset to default state and then start the normal operation. It should also reset the power burner in the module to consume the default power, 1.5W.

Hard-reset(ResetL)

The hard-reset should cause the microcontroller to reset, and then reset all the other active components and reset the power burner to consume the default power, 1.5W. Afterward, the microcontroller will start the normal operation.

Soft-reset

The soft-reset should cause the microcontroller to reset, and then reset all the other active components and reset the power burner to consume the default power, 1.5W. Afterward, the microcontroller will start the normal operation. The soft-reset is set by host through the I2C register 26 bit 3.

Table 4: Soft-reset register

Page	Address	Bits	Name	Description	Type
N/A	26	3	Software Reset	Software reset	RW, Self-Clear

Programmable power consumption/burner

During power-up of the module, the power burner in the module should burn maximum 1.5W power as default. Afterward, host can set the module to consume more power through a I2C register 200.

Table 5: power burner registers

Page	Address	bits	Name	Description	Type
00h	200	7-5	Module Card Power Class	000b: Power consumption: 1.5W (default) 001b: Power consumption: 3.5W 010b: Power consumption: 5.0W 011b: Power consumption: 7.0W 100b: Power consumption: 10.0W 101b: Power consumption: 12.0W 110b: Power consumption: 14.0W 111b: Power consumption: 16.0W The tolerance of power consumption must meet the following criteria +/-5% @ VCC = 3.3V +/-2% +/-11% @ VCC = 3.3V +/-5% +/-20% @ VCC = 3.3v +/-10%	RW
		4	Reserved / Maximum Module Card Power Class	0b: Power consumption is set by the Module Card Power Class register (default) 1b: Power consumption: 20.0W	RO
		3-0	Maximum Power Identifier	bxxxx_001x: 14-Watt loopback bxxxx_00xx: 16-Watt loopback bxxxx_10xx: 20-Watt loopback	RO

				bxxxx_11xx: 0-Watt loopback Refer to address 201 (or Customizable power)	
--	--	--	--	--	--

Power distribution

The power burner will be placed on the top side of paddle PCB with all the heat be dissipated at the top of the case. The power burner is separated into 3 regions (0W loopback without burner) :



Table 6: Burner Power distribution registers

Page	Address	Bits	Value	Power consumption			
				Module	Region 1	Region 2	Region 3
00h	200	7-4	0000b	1.5W	1.5W	0W	0W
			0010b	3.5W	3.5W	0W	0W
			0100b	5.0W	5.0W	0W	0W
			0110b	7.0W	5.0W	2.0W	0W
			1000b	10.0W	5.0W	5.0W	0W
			1010b	12.0W	5.0W	7.0W	0W
			1100b	14.0W	5.0W	9.0W	0W
			1110b	16.0W	5.0W	11.0W	0W
			xxx1b	20.0W	5.0W	11.0W	4.0W

Table 7: Low-Speed Signal status registers

Page	Address	bits	Name	Description	Type
FFh	225	2	ModSelL signal status	0b: logical 0, $V_{ModSelL} < V_{ii}(max)$ 1b: logical 1, $V_{ModSelL} > V_{ih}(min)$	RO
		1	InitMode	0b: logical 0, $V_{InitMode} < V_{ii}(max)$	RO

		signal status	1b: logical 1, $V_{InitMode} > V_{ih(min)}$	
--	--	---------------	---	--

Table 8: Low-Speed Signal state transaction registers

Page	Address	bits	Name	Description	Type
FFh	225	5	ModSelL transition	Read 0b: No edge detected Read 1b: Either rising or falling edges detected Write 0b: No effect Write 1b: Clear the register	RW
		4	InitMode transition	Read 0b: No edge detected Read 1b: Either rising or falling edges detected Write 0b: No effect Write 1b: Clear the register	RW

ModSelL

The ModSelL is Low, the module responds to TWI serial communication commands.

The ModSelL is High, the module shall not respond to or acknowledge any TWI interface communication.

InitMode

The InitMode is Low, the power burner in the module to consume the setting power.

The InitMode is High, the module enter low power mode.

ModPrsL

The ModPrsL is pulled towards ground in the module.

IntL

The IntL signal is asserted Low with any of Alarm and Warning flag is set and deasserted High after all of Alarm and Warning flags are read.

Contact pads insertion requirement and module reliability

The contacts pads on the paddle card is wished to handle 2000 physical insertions while maintain the lane insertion loss at the end of the 2000th physical insertion. The value of guaranteed maximum insertion/temperature cycle is saved in I2C registers in upper page 0Xff

Table 9: Contact pads insertion cycle registers

Page	Address	Size	Name	Description	Type
FFh	252	1	Guaranteed maximum insertion/temperature	Guaranteed maximum insertion/temperature cycle in hex.	RO

			cycle, MSB	The goal is 2000 (07D0h) insertions.	
	253	1	Guaranteed maximum insertion/temperature cycle, LSB		RO

Package Outline

Dimensions are in millimeters. (Unit: mm)

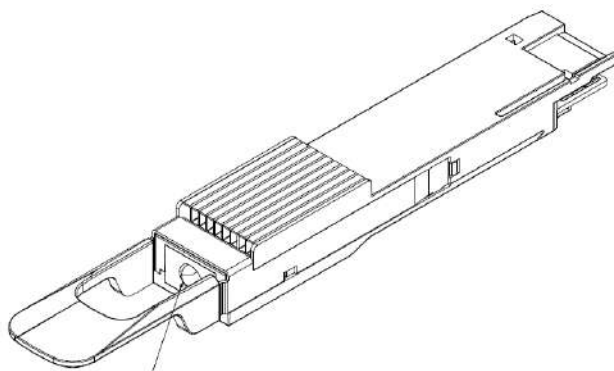
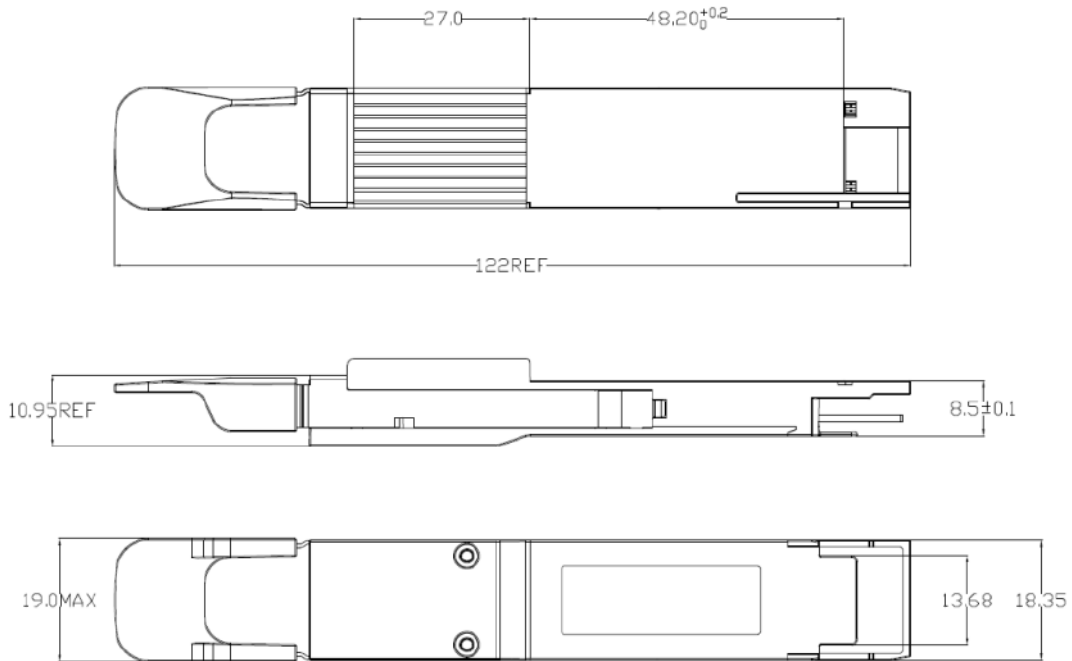

LED:
 Solid green: low-power mode
 Solid red: high-power mode
 Blinking green: low-power mode with any of the interrupt flag is set
 Blinking red: high-power mode with any of the interrupt flag is set