

2J4A24Pa

CELLULAR/LTE MIMO Adhesive Mount

Key Features

Cable 1 and 2: CELLULAR / LTE

- 698-960 MHz
- 1710-2170 MHz
- 2500-2700 MHz

Adhesive Mount

High Performance

Ground Plane Independent

Customizable Cable and Connector

Dimensions: 61.8 x 155.6 x 17.0 mm

Certificates: IP67, IP69

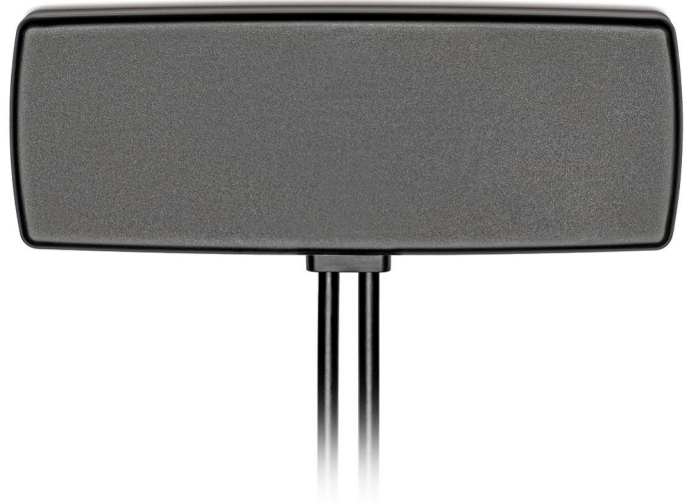

1. Antenna Description

2J4A24Pa “The Condor Series”

A stellar performance in a compact system

With a size reduction of up to 50% in comparison with other antennas in the market and the highest performance for a 2-in-1 antenna solution, single package the Condor 2J4A24Pa antenna is the most competitive solution on the market. Users can opt for other configurations in the same enclosure such as 3-in-1, 4-in-1 or 5-in-1 antenna as per their needs, please check our website or contact our sales team for questions and details.

If you are looking for an antenna that is sleek in design and makes no compromises on efficiency and performance, then 2J4A24Pa is the best option. Engineered according to the latest technological advancements, this antenna provides LTE-MIMO, delivering very high-efficiency uninterrupted data transfers at maximum speed, achieved by the low Envelope Correlation Coefficient at the LTE-MIMO Antennas.

Worldwide solution

The key feature here is that 2J4A50PCFc is compatible with all LTE, 4G, 3G or 2G network ecosystems. With countless applications and customer-centric benefits.

Typical applications

- Infotainment systems
- HD video transmission
- Dash cameras
- Connected cars
- Self-driving cars
- Fleet management
- Gateways
- Routers
- Public transportation
- Logistics
- And others

Compatibility Standards

LTE Cables

- CAT 1 2 3 4 5 6 7 8 9 10 11 12
- NB-IoT, LTE-NB1, CAT-M1, CAT-M2, WCDMA, UMTS, HSPA,
- EDGE GRPS, GSM, CDMA

Installation and Durability

The 2J4A24Pa can be easily installed or hidden in any part of your environment and application; on the top or bottom surfaces including windshields, dash, plastic, etc., as it comes equipped with a separate double adhesive pad that secures it safely. This product includes a low loss double shielded cable with fully customized length and connector that provides maximum antenna performance and reliability, avoiding drop connections, higher speed data, higher gain, etc. 2-in-1 feature allows for a quick handling in places where other solutions fail to implement and eliminates the need for the extensive labor involved in the installation of the product, saving time and resources.

Not only does this technology assure smooth performance, but it also comes bearing safety guarantee. With IP67 and IP69K ingress rating, our product provides maximum protection against dust and water and allows high pressure and steam cleaning. Passing drop test and vibration provides extra robustness ensuring longevity of the product, making it a cost-effective solution. Certificates for independent lab test are available under NDA.

The UV coating allows maximum protection against extensive outdoor use in extreme environments and temperatures.

2. Antenna and electrical specifications

Cable 1

Parameters	CELLULAR / LTE Antenna		
Standards	2G,3G and 4G		
Band (MHz)	700/850/900	1700/1800/1900/2100	2600
Frequency (MHz)	698-960	1710-2170	2500-2700
Return Loss (dB)	~-12.2	~-18.8	~-10.7
VSWR	~1.8:1	~1.3:1	~1.9:1
Efficiency (%)	~52.9	~63.2	~45.1
Peak Gain (dBi)	~-2.2	~-3.6	~-2.9
Average Gain (dB)	~-2.9	~-2.0	~-3.5
Impedance (Ohm)	50		
Polarisation	Linear		
Radiation Pattern	Omni-Directional		
Max. Input Power (W)	25		
Connector Type	SMA-Male Standard (Other Connectors Available)		
Cable Length	300 cm Standard (Any Cable Length Available)		
Cable Type	LMR195 (Other Cables Available)		

Cable 2

Parameters	CELLULAR / LTE Antenna		
Standards	2G,3G and 4G		
Band (MHz)	700/850/900	1700/1800/1900/2100	2600
Frequency (MHz)	698-960	1710-2170	2500-2700
Return Loss (dB)	~-10.5	~-17.5	~-16.0
VSWR	~2.0:1	~1.4:1	~1.4:1
Efficiency (%)	~45.1	~58.9	~49.9
Peak Gain (dBi)	~-1.1	~-4.4	~-4.2
Average Gain (dB)	~-3.5	~-2.3	~-3.0
Impedance (Ohm)	50		
Polarisation	Linear		
Radiation Pattern	Omni-Directional		
Max. Input Power (W)	25		
Connector Type	SMA-Male Standard (Other Connectors Available)		
Cable Length	300 cm Standard (Any Cable Length Available)		
Cable Type	LMR195 (Other Cables Available)		

Antenna Measurement Conditions:

Mounted on Plastic Plate of 30 x 30 cm

200 cm of Cable LMR195

Measured in Certified CTIA 3D Anechoic Chamber

3. Mechanical and environmental specifications

Specifications	2J4A24Pa
Mounting Type	Adhesive Mount
Dimensions (mm)	61.8 x 155.6 x 17.0
Radome Type	ASA UV Stable
Radome color	Black
Operating Temperature (C)	-40 to +85
Storage Temperature (C)	-40 to +85
Substance Compliance	RoHS
Certificates	IP67, IP69

4. Antenna parameters

Table 1: CELLULAR/LTE

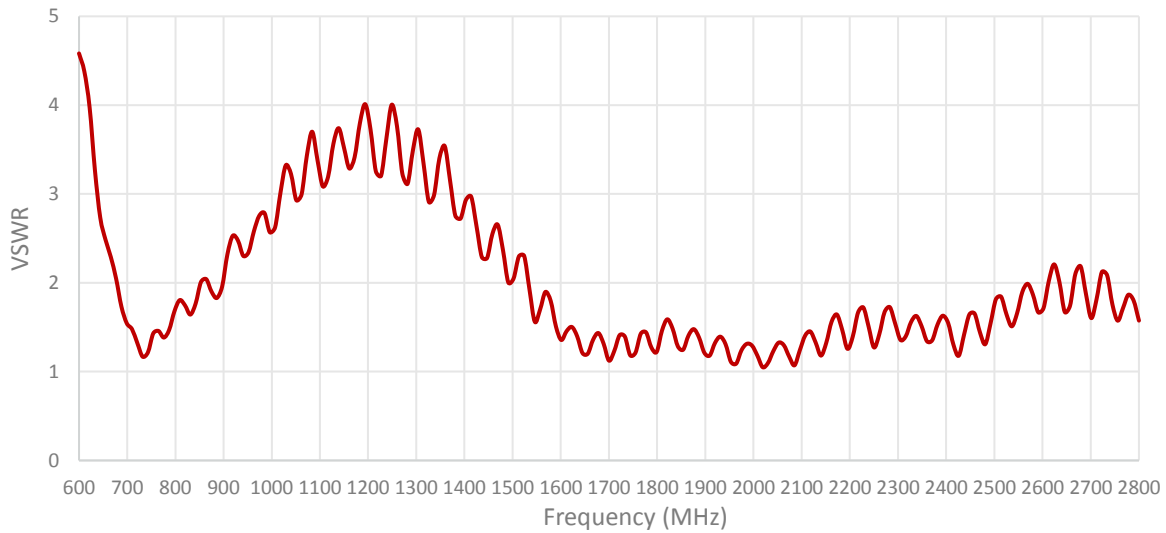
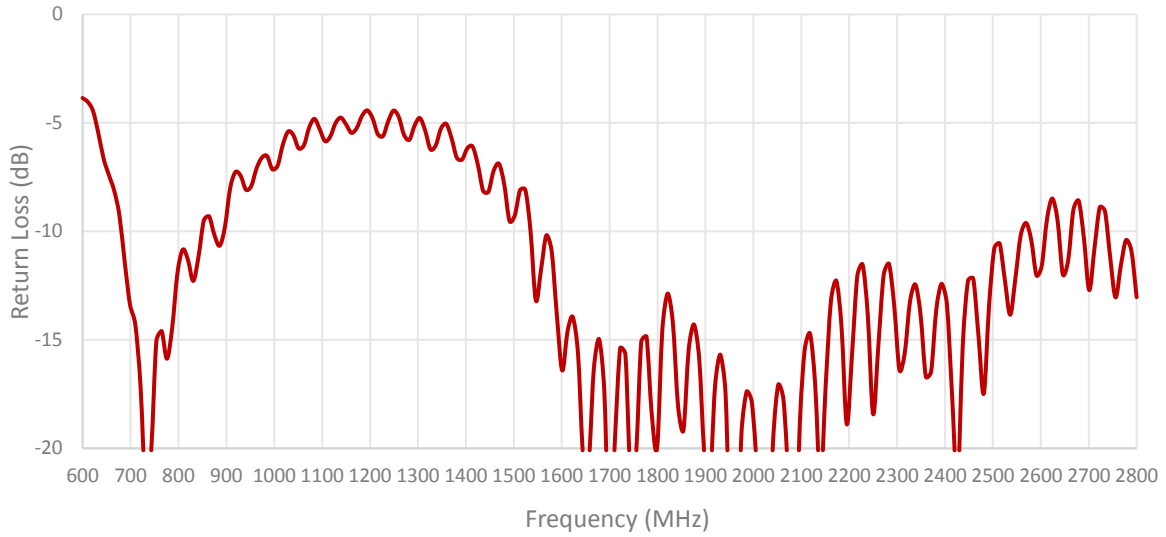

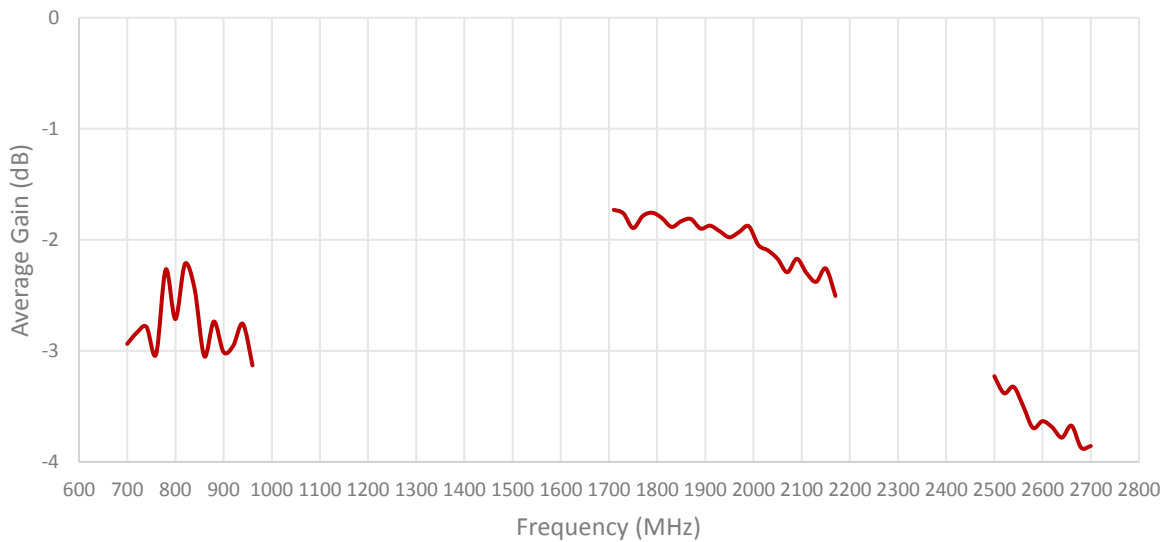
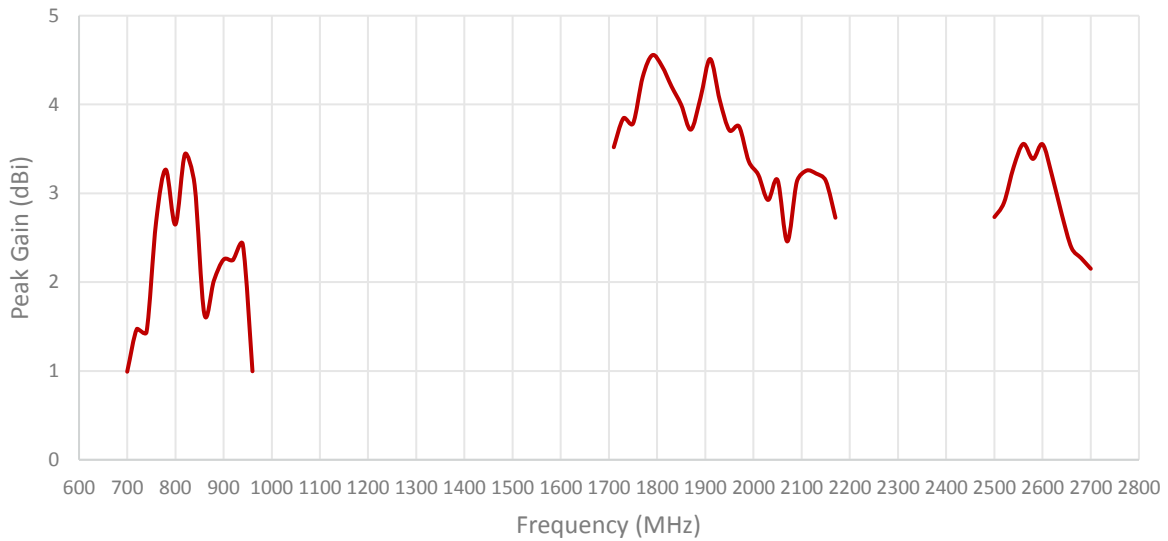
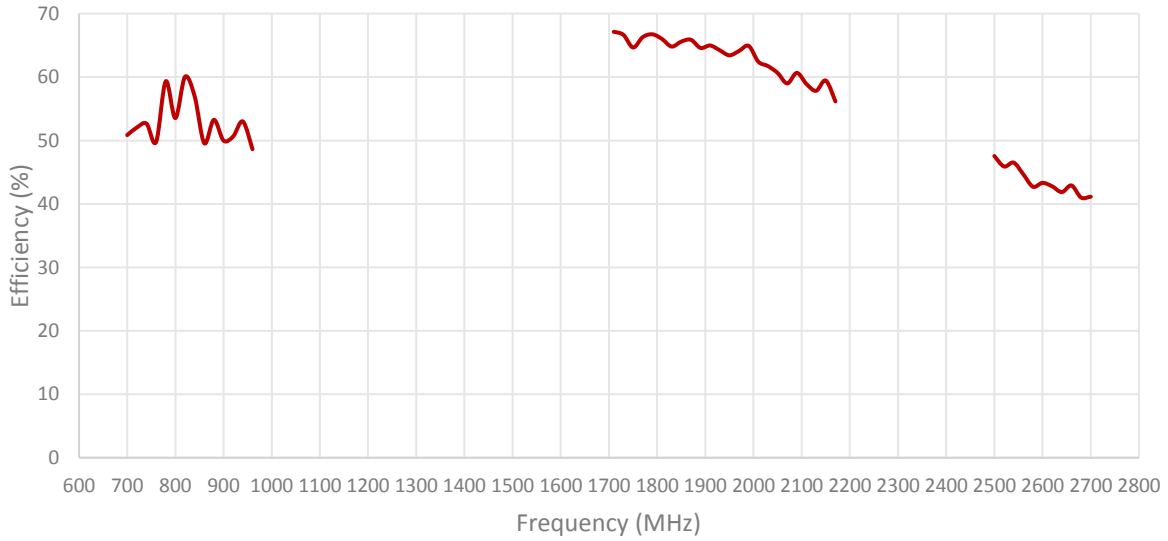
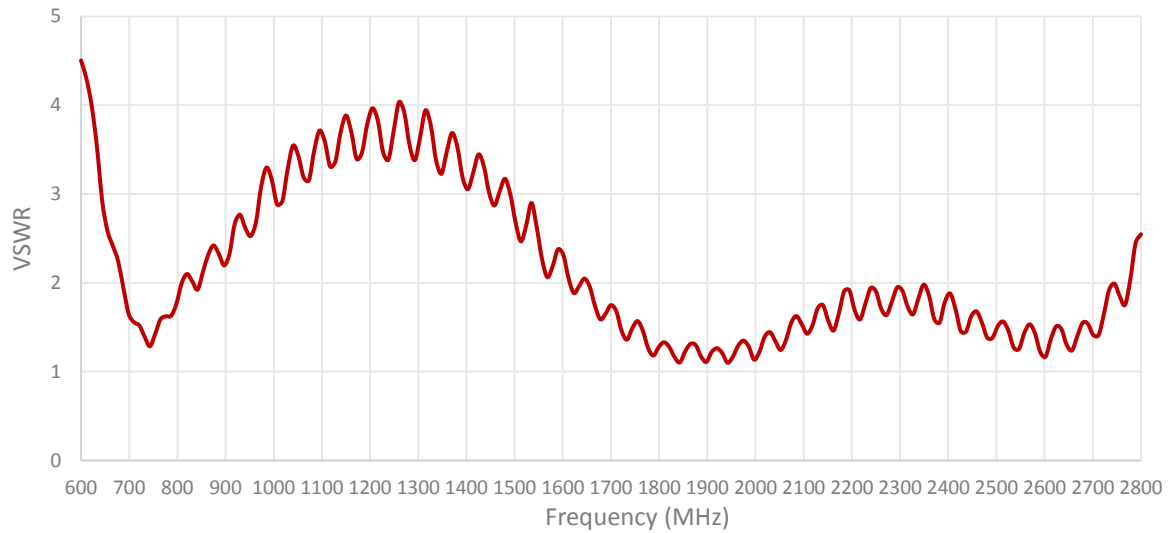
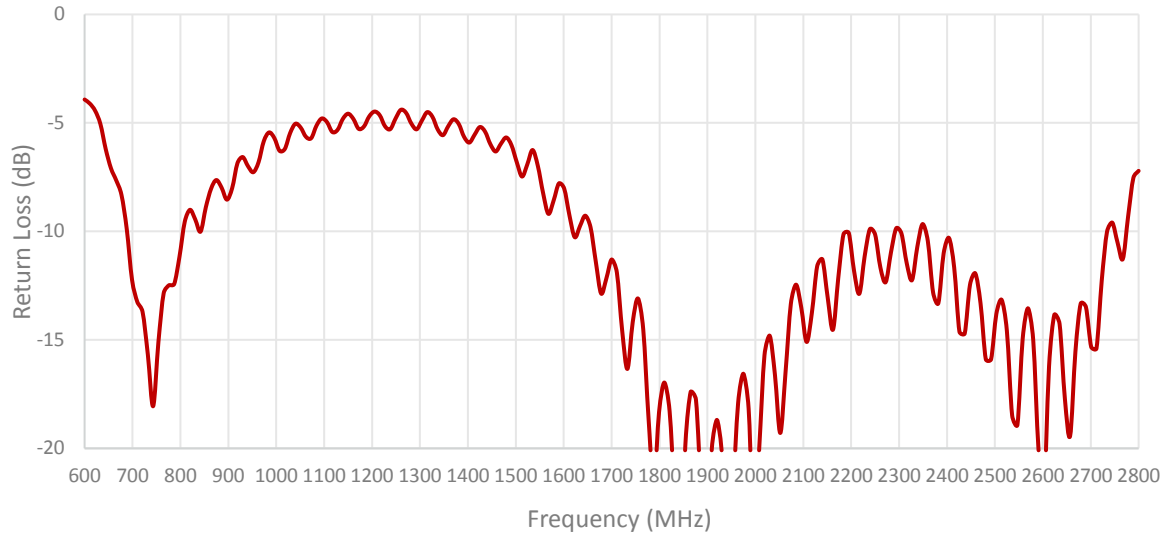
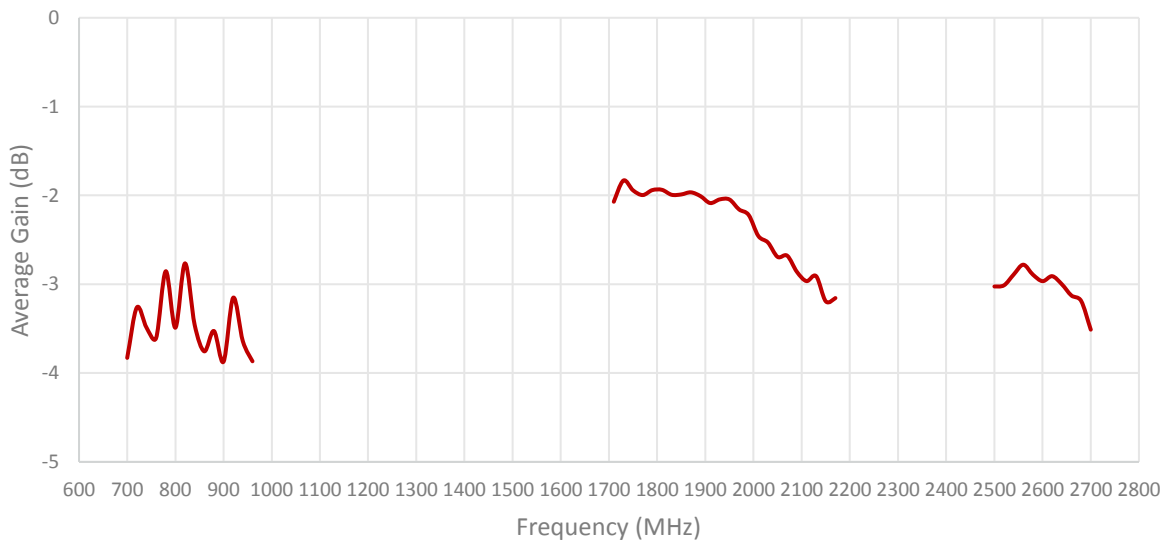
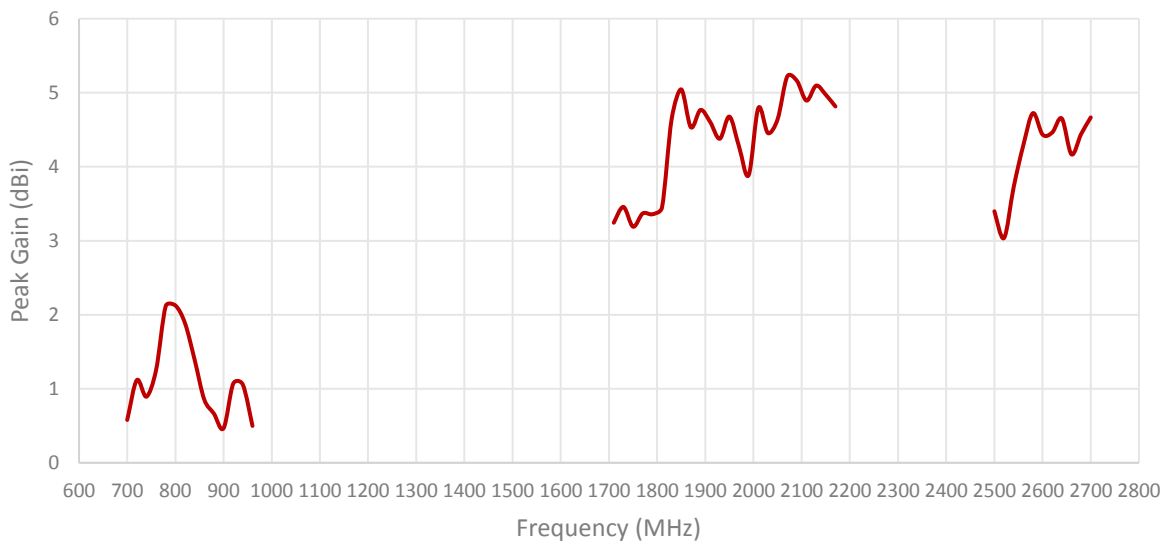
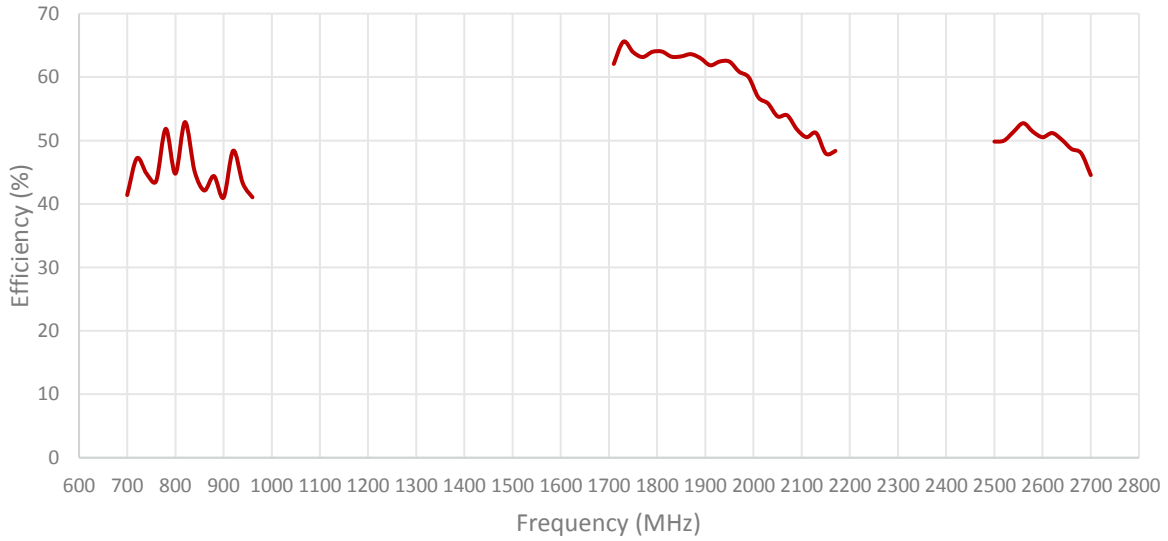
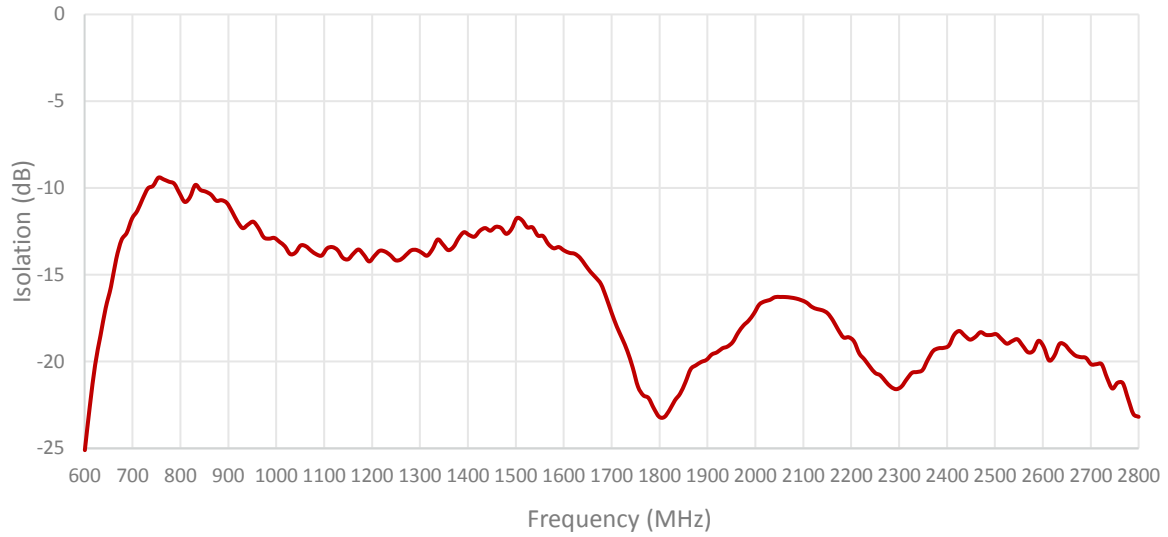

Table 2: CELLULAR/LTE





ISOLATION FOR CABLES 1 AND 2



ENVELOPE CORRELATION COEFFICIENT FOR CABLES 1 AND 2

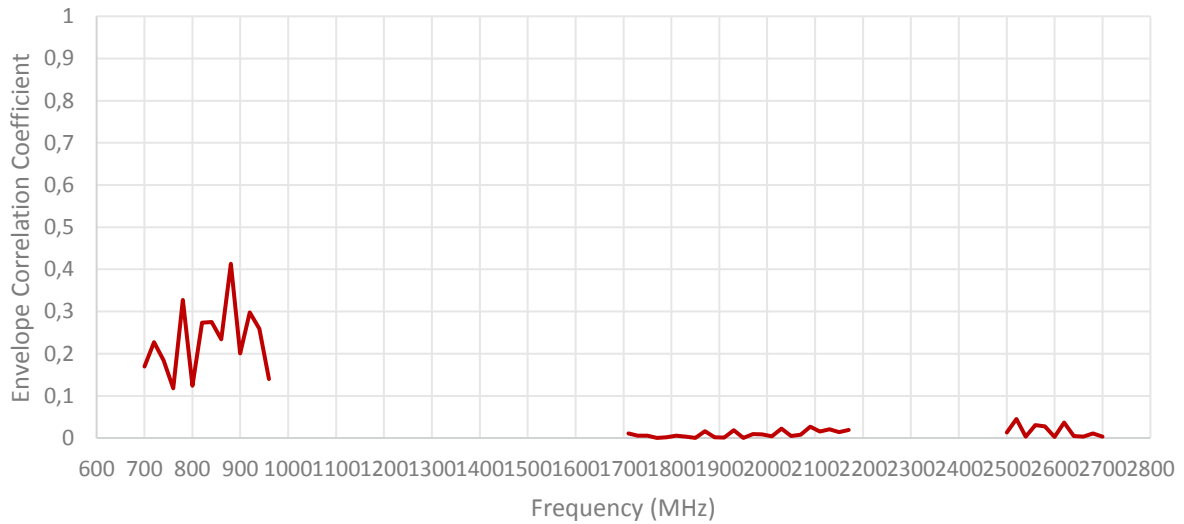

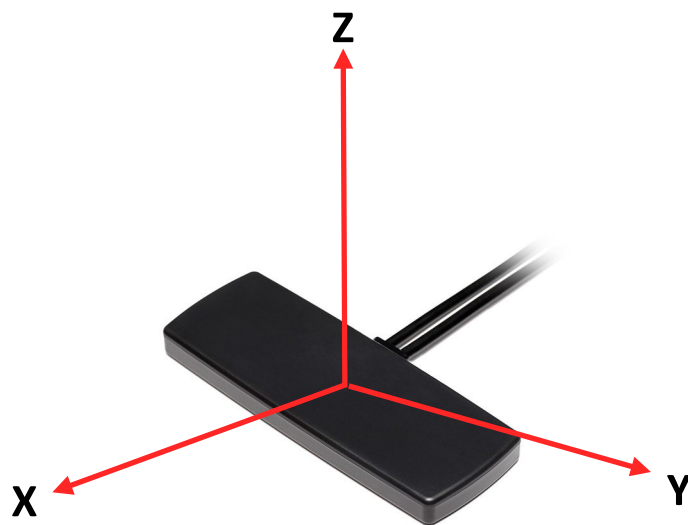

Radiation pattern reference

Cable 1: CELLULAR/LTE

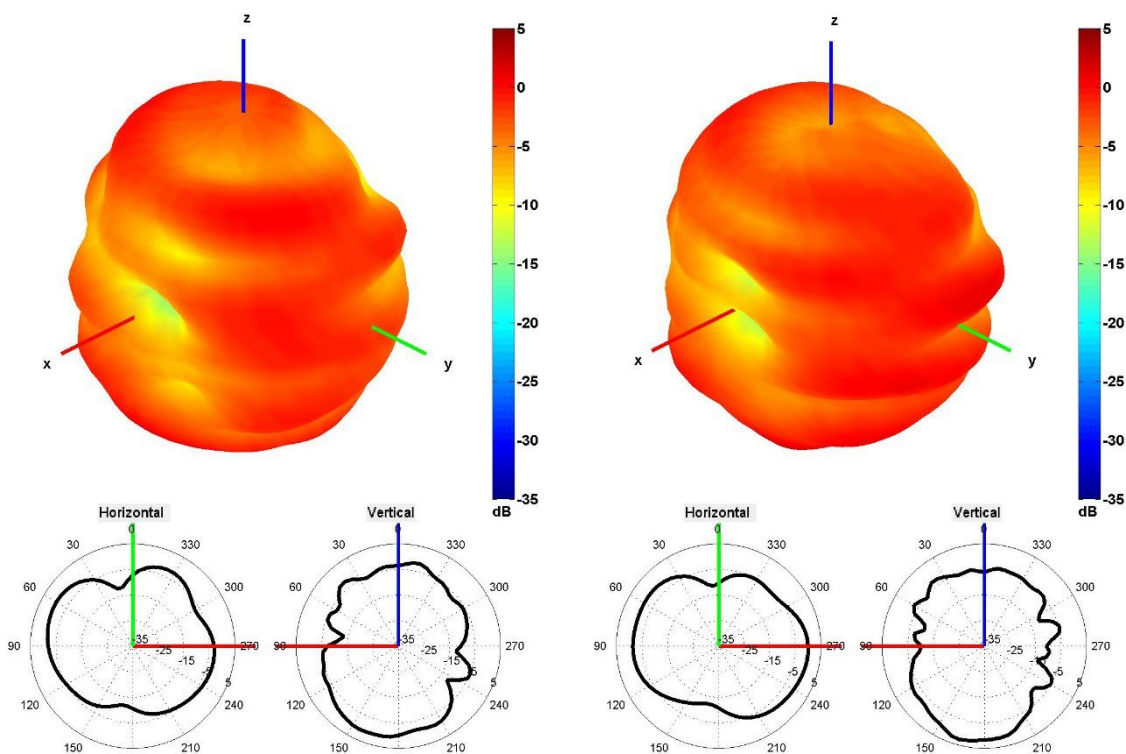

750 and 850 MHz Radiation pattern

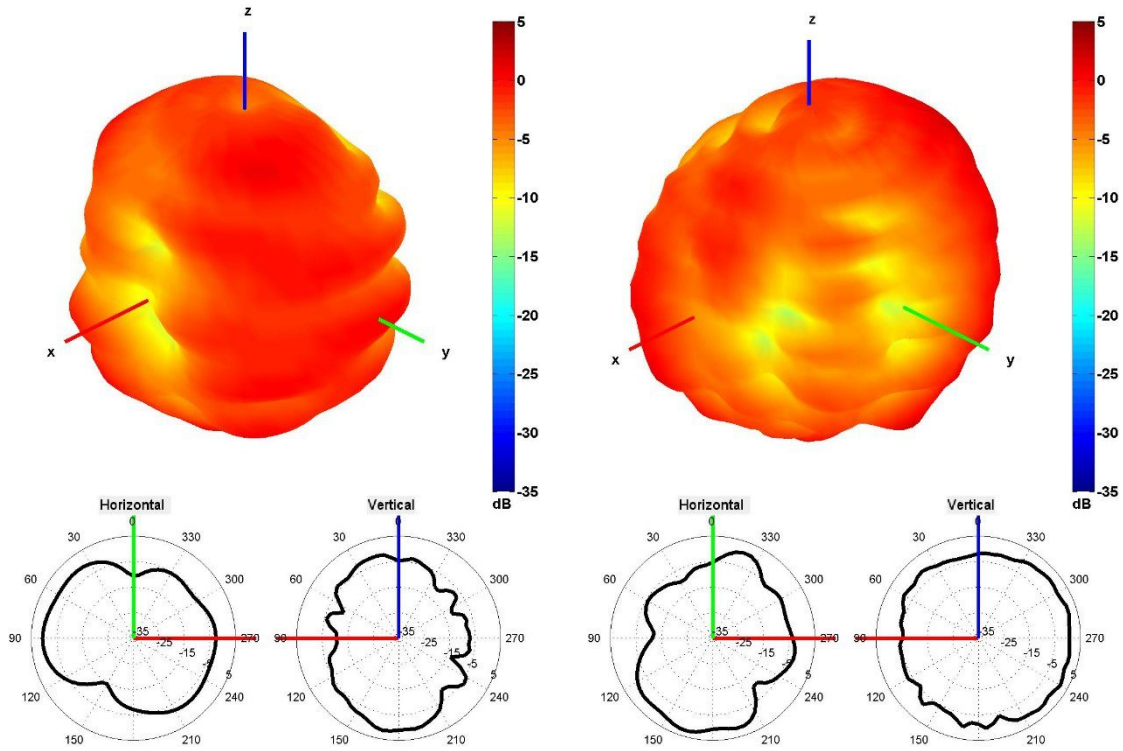

940 and 1750 MHz Radiation pattern

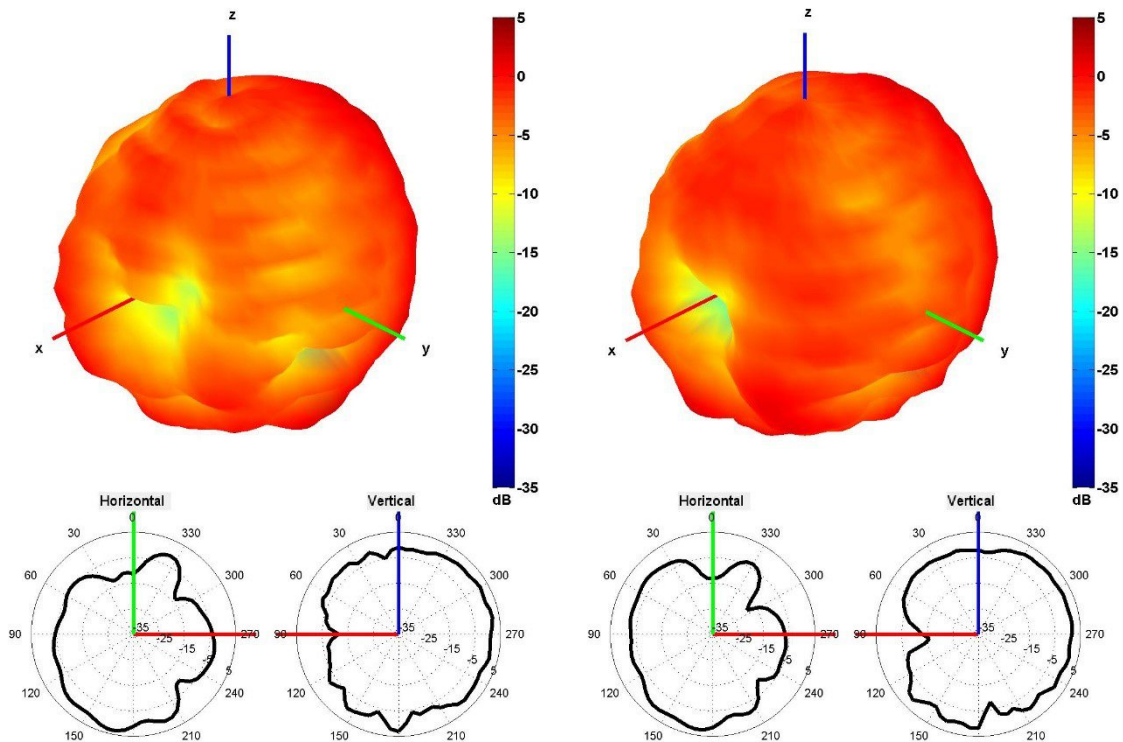

1850 and 1950 MHz Radiation pattern

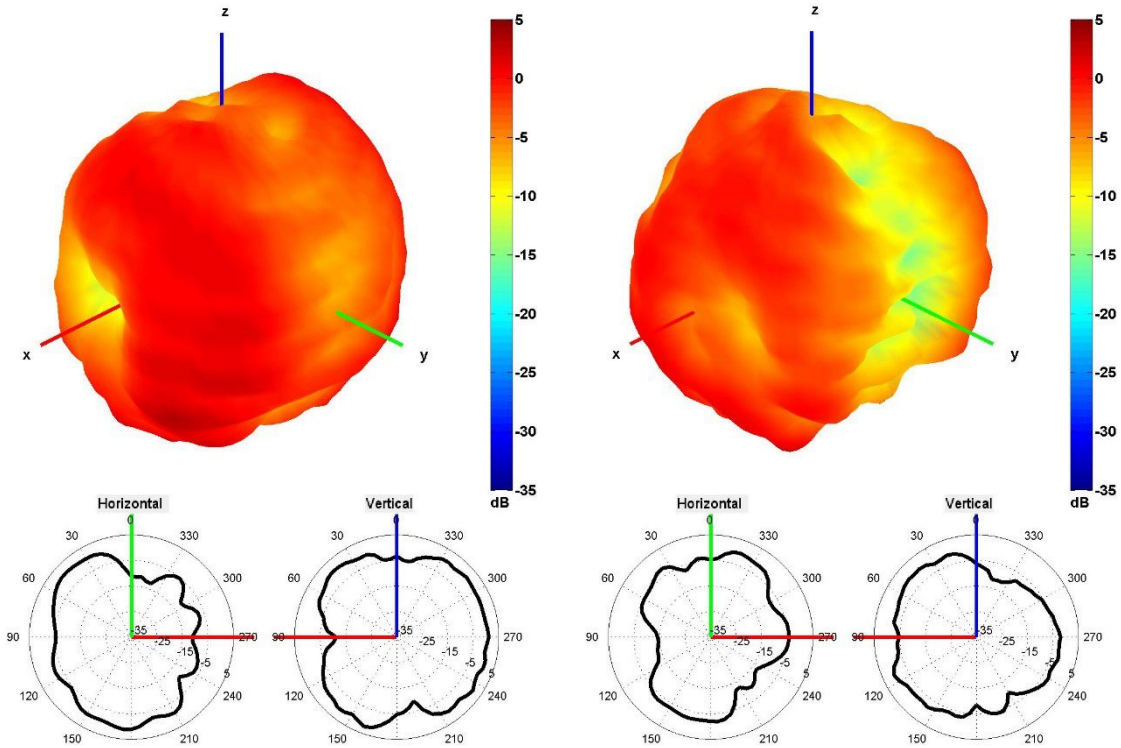

2100 and 2600 MHz Radiation pattern

Cable 2: CELLULAR/LTE

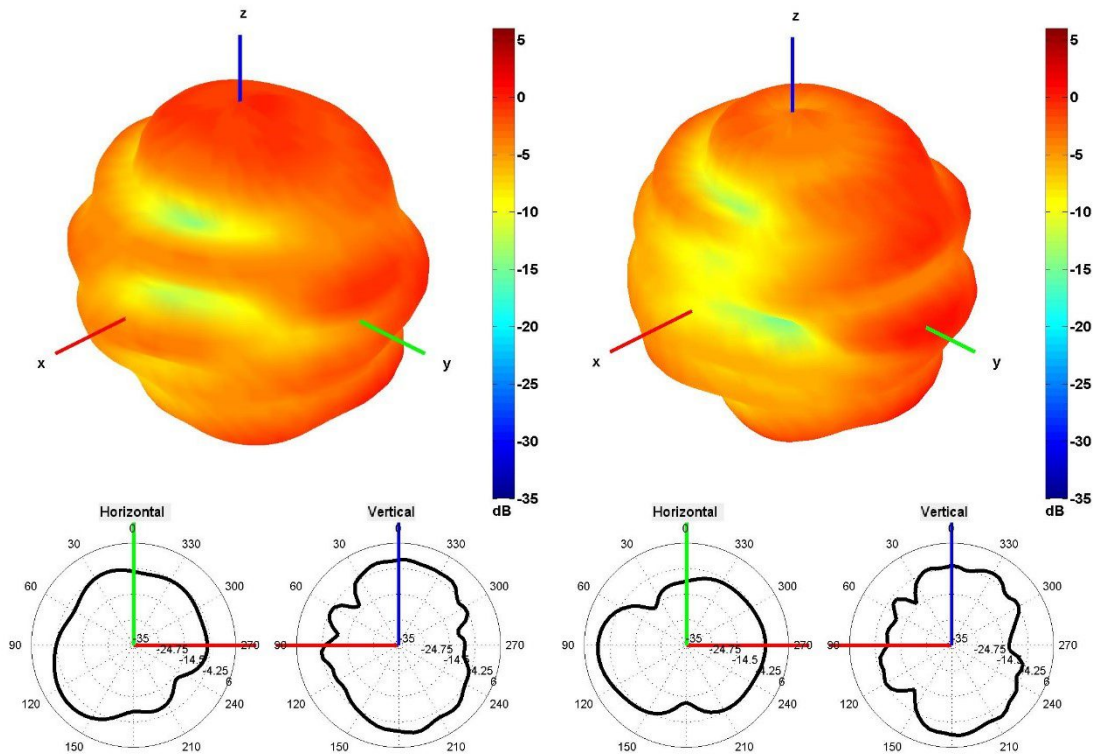

750 and 850 MHz Radiation pattern

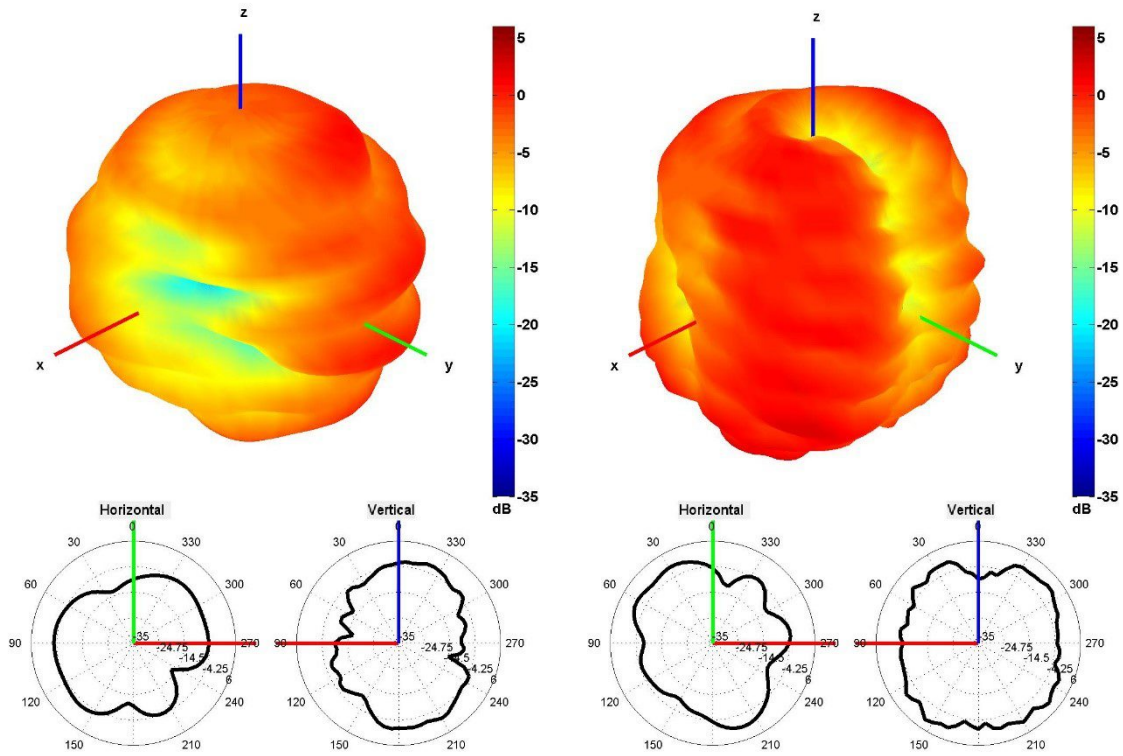

940 and 1750 MHz Radiation pattern

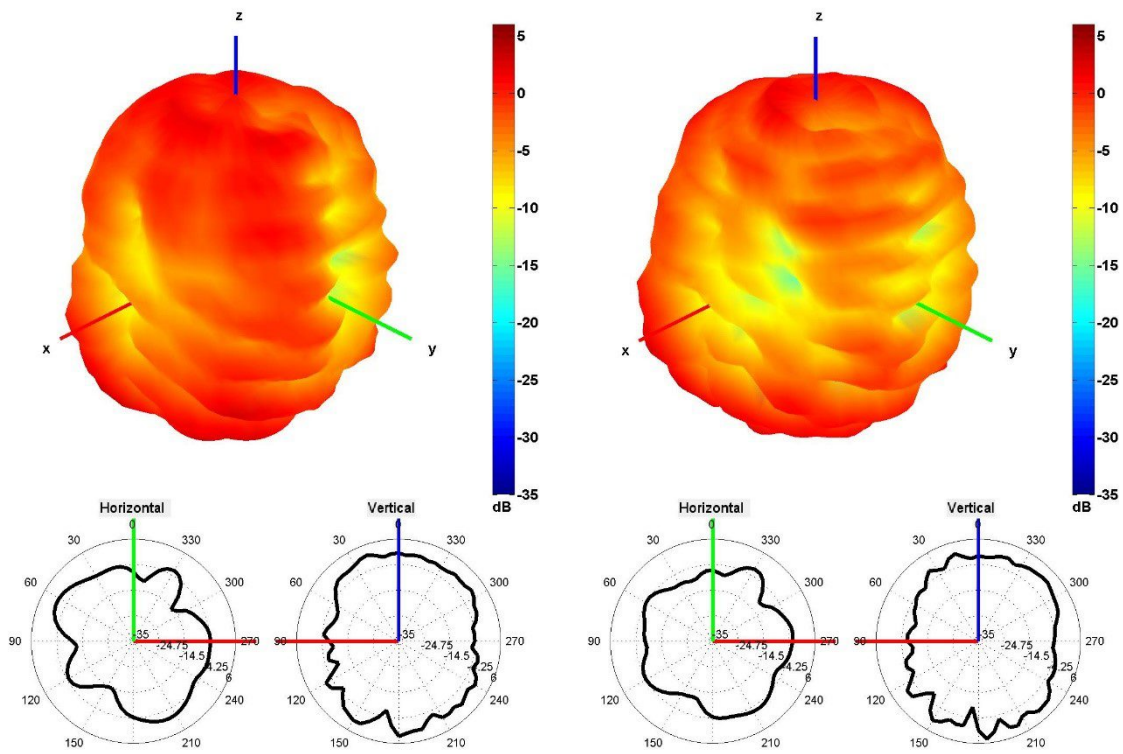

1850 and 1950 MHz Radiation pattern

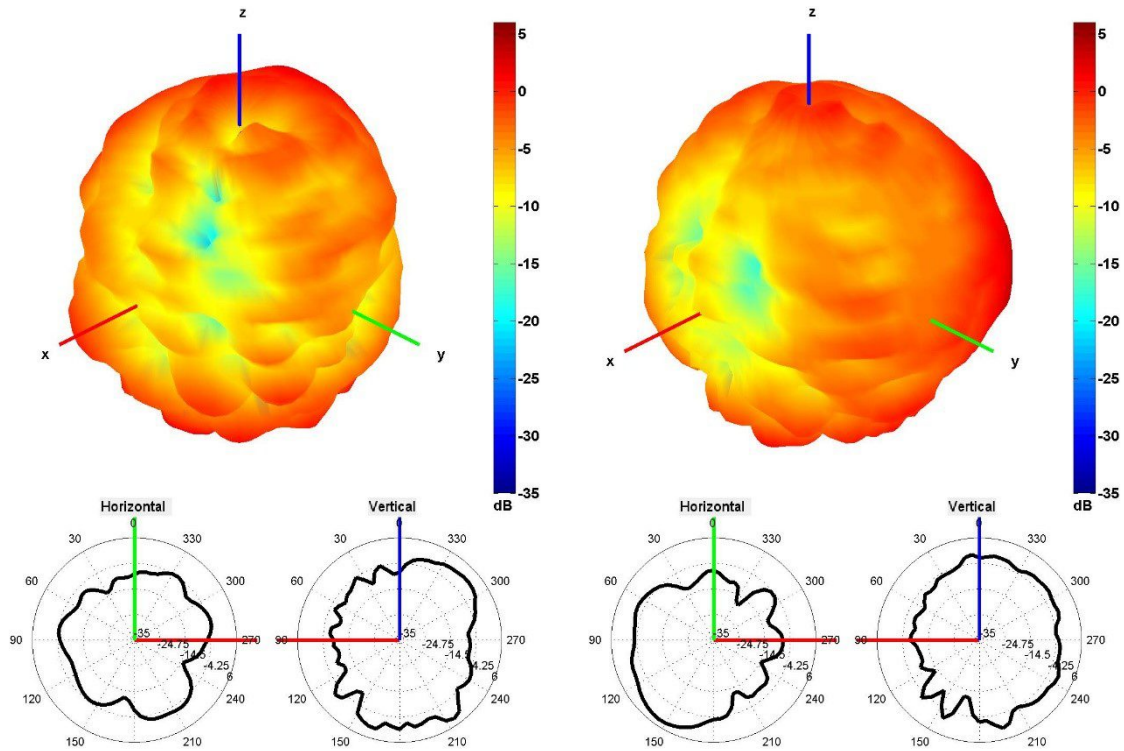

2100 and 2600 MHz Radiation pattern

5. Antenna drawings

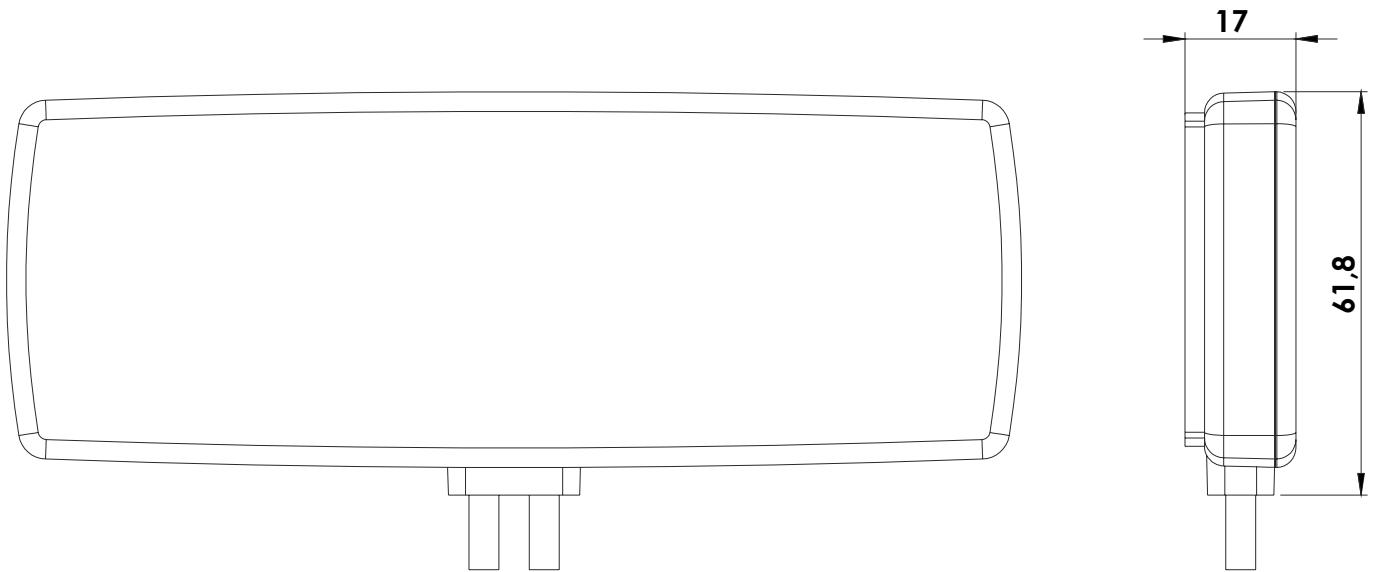
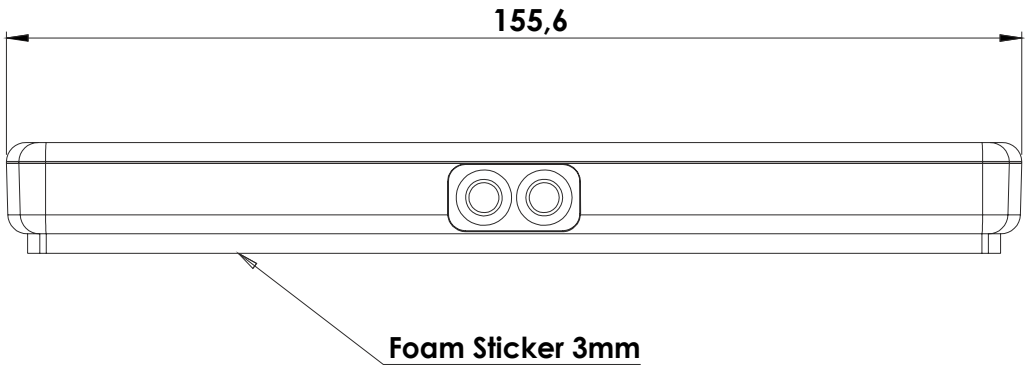

6. Antenna Images

