

Montageadapter Typ 01.109.028
M8 auf M10

Mounting Adapter Type 01.109.028
M8 on M10

Technische Daten / Technical Data

Montageadapter

Innengewinde: M8 x 10 mm, Steigung: 1.25 mm
 Außengewinde: M10 x 18 mm, Steigung: 1.5 mm
 Material: Edelstahl, Typ V4A,
 Werkstoff Nr.: 1.4404 (AISI 316L)

Mounting Adapter

Inner thread: M8 x 10 mm, pitch: 1.25 mm
 External thread: M10 x 18 mm, pitch: 1.5 mm
 Material: Stainless Steel, Type V4A,
 Material Nr.: 1.4404 (AISI 316L)

Abmessungen / Dimensions

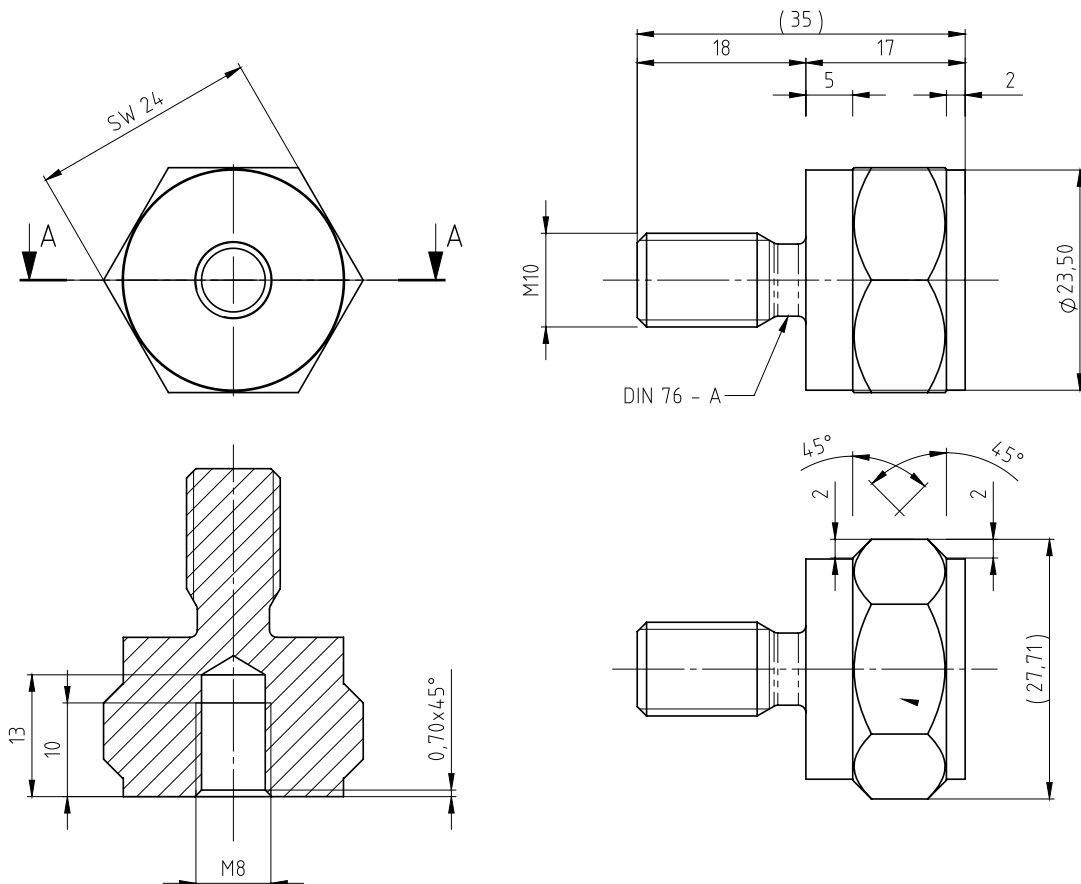

Alle Maße in mm / All measures in mm