

# PCM 200/75 G



Sample image

**Order symbol :** PCM 200/75 G

**Product nr :** 6016326

**Description :** Enclosure, PC, metric knock-outs

**Remarks :** Grey cover

**EAN :** 6418074038142

**El. number :**

- Finland : 3421652
- Denmark : 8212027284
- Sweden : 2535345

**Including :** Base with TPE gasket. screws for mounting plate/DIN-rail and cover with polyamide cover screws.

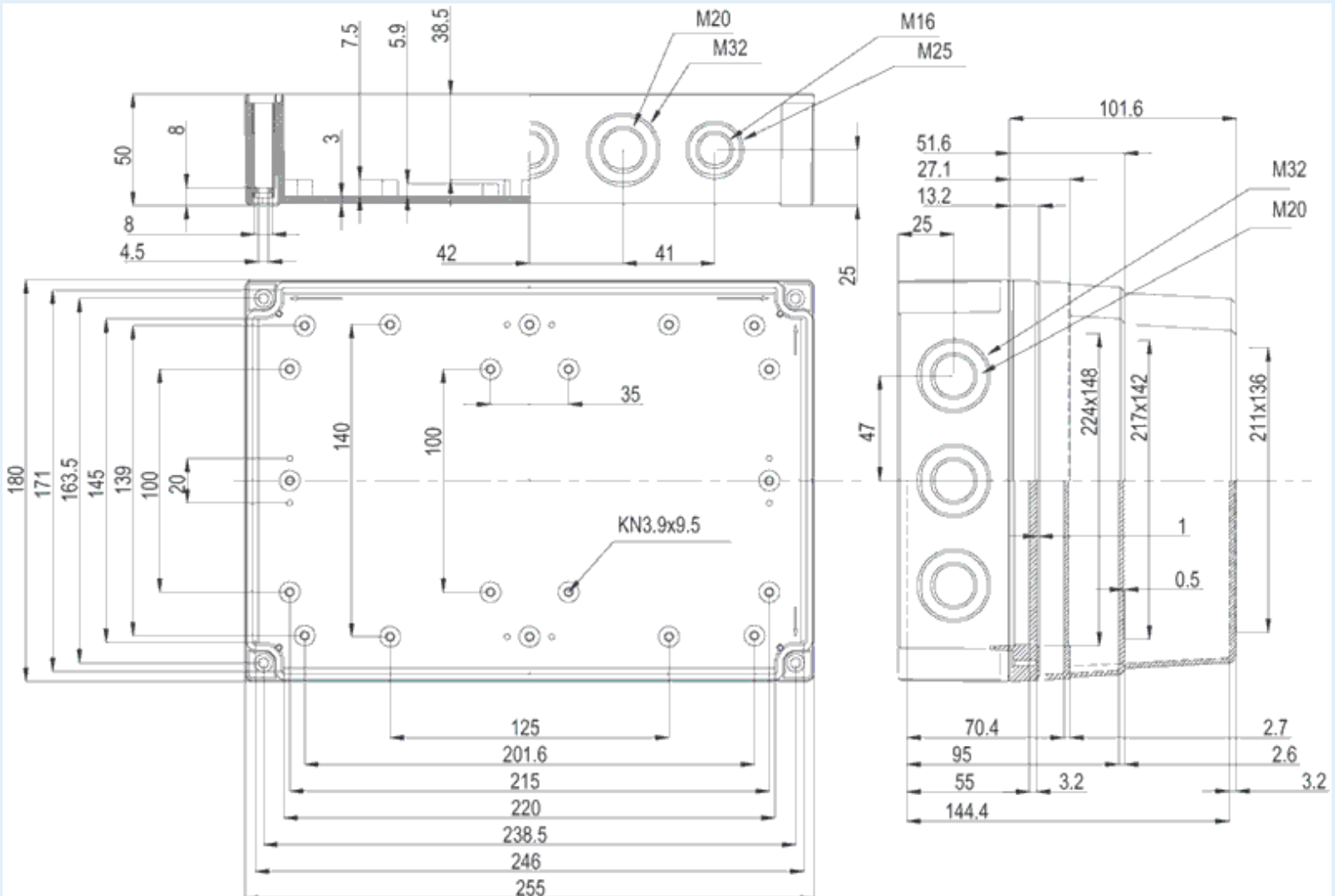

<b>Dimensions :</b>	<b>Height</b>	<b>Width</b>	<b>Depth</b>
mm :	255	180	75

#### **Materials :**

Material :	Polycarbonate
Base colour :	RAL_7035
Cover colour :	RAL 7035 -light grey
Gasket material :	Polyurethane

#### **Temperatures :**

Temperature °C (continuous) :	-40 ... 80
Temperature °F (continuous) :	-40 ... 175

#### **Accessories :**

MIN 20	DIN-15 Mounting rail, for enclosures: (225 x 15 x 1)
HFP 180	Front plate hinge series
MIN 15	DIN-15 Mounting rail, for enclosures: (150 x 15 x 1)
MIV 200	Mounting plate (Galvanized steel), for enclosures: (223 x 148 x 1)
FP A 200/ 180	Front plate (Aluminium), for enclosures: (237 x 170 x 1)
MIV 15	DIN-35 Mounting rail, for enclosures: (150 x 35 x 1)
FP 22046	Wall fastening lug (4 pcs)
MIV 20	DIN-35 Mounting rail, for enclosures: (225 x 35 x 1)

#### **Ratings :**

Ingress protection (EN 60529):	IP66; IP67;
Impact Resistance (EN 62262):	IK08;
electrical_insulation :	Totally insulated
Halogen free (DIN/VDE 0472, Part 815) :	Yes
UV resistance :	UL 746C
Flammability Rating :	UL 94 V0
Glow Wire Test (IEC 695-2-1) °C :	960C

#### **Certificates :**

Certificate FI 40847