

BCF 3.81/06/180 SN BK BX

Weidmüller Interface GmbH & Co. KG
 Klingenbergstraße 26
 D-32758 Detmold
 Germany

www.weidmueller.com

Product image

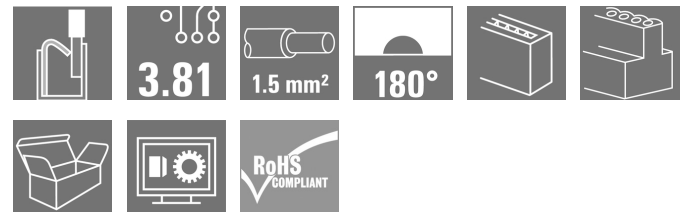

PUSH IN - Weidmüller's innovative connection system simplifies the wire connection process.

The benefits for users and applications:

- High packaging density due to very low component height. Simply insert the prepared wire - finished
- High component density with the compact SCDN / SCDN-THR two-tier pin header
- Simplified processing due to integrated push buttons for opening the clamping unit
- Intuitive handling – since the wire-entry area and handling area are clearly separated
- tool-free locking and releasing when using Weidmüller's patented release latch (LR)

The Weidmüller plug-in connectors, pitch 3.81 mm (0.15 inch), are compatible with the layout of customary plug-in connectors, can be coded and provide space for printing.

General ordering data

Version	PCB plug-in connector, female plug, 3.81 mm, Number of poles: 6, 180°, PUSH IN with actuator, Tension-clamp connection, Clamping range, max. : 1.5 mm², Box
Order No.	1969980000
Type	BCF 3.81/06/180 SN BK BX
GTIN (EAN)	4032248679560
Qty.	50 Stück
Product data	IEC: 320 V / 17.5 A / 0.14 - 1.5 mm² UL: 300 V / 10 A / AWG 26 - AWG 16
Packaging	Box

BCF 3.81/06/180 SN BK BX

Weidmüller Interface GmbH & Co. KG
 Klingenbergstraße 26
 D-32758 Detmold
 Germany

www.weidmueller.com

Technische Daten

Dimensions and weights

Depth	22 mm	Depth (inches)	0.866 inch
Height	7.9 mm	Height (inches)	0.311 inch
Width	22.95 mm	Width (inches)	0.904 inch
Net weight	4.42 g		

System Parameters

Product family	OMNIMATE Signal - series BC/SC 3.81	Type of connection	Field connection
Wire connection method	PUSH IN with actuator, Tension-clamp connection	Pitch in mm (P)	3.81 mm
Pitch in inches (P)	0.15 "	Conductor outlet direction	180°
Number of poles	6	L1 in mm	19.05 mm
L1 in inches	0.75 "	Number of rows	1
Pin series quantity	1	Rated cross-section	1 mm ²
Touch-safe protection acc. to DIN VDE 57 106	Safe from finger touch	Touch-safe protection acc. to DIN VDE 0470	IP20 plugged/ IP10 unplugged
Protection degree	IP20	Volume resistance	≤5 mΩ
Can be coded	Yes	Stripping length	9 mm
Screwdriver blade	0.4 x 2.5	Screwdriver blade standard	DIN 5264
Plugging cycles	25	Plugging force/pole, max.	8 N
Pulling force/pole, max.	7 N		

Material data

Insulating material	PA 66 GF 30	Colour	black
Colour chart (similar)	RAL 9011	Insulating material group	II
Comparative Tracking Index (CTI)	≥ 550	UL 94 flammability rating	V-0
Contact material	Cu-alloy	Contact surface	tinned
Layer structure of plug contact	4...8 μm Sn matt	Storage temperature, min.	40- °C
Storage temperature, max.	70 °C	Operating temperature, min.	50- °C
Operating temperature, max.	120 °C	Temperature range, installation, min.	25- °C
Temperature range, installation, max.	120 °C		

Conductors suitable for connection

Clamping range, min.	0.14 mm ²
Clamping range, max.	1.5 mm ²
Wire connection cross section AWG, min.	AWG 26
Wire connection cross section AWG, max.	AWG 16
Solid, min. H05(07) V-U	0.14 mm ²
Solid, max. H05(07) V-U	1.5 mm ²
Flexible, min. H05(07) V-K	0.14 mm ²
Flexible, max. H05(07) V-K	1.5 mm ²
w. plastic collar ferrule, DIN 46228 pt 4, min.	0.25 mm ²
w. plastic collar ferrule, DIN 46228 pt 4, max.	1 mm ²
w. wire end ferrule, DIN 46228 pt 1, min.	0.25 mm ²
w. wire end ferrule, DIN 46228 pt 1, max.	1.5 mm ²
Plug gauge in accordance with EN 60999 a x b; ø	2.4 mm x 1.5 mm; 1.9mm

Erstellungs-Datum 05 2024, CET 10:59:59 ص

BCF 3.81/06/180 SN BK BX

Weidmüller Interface GmbH & Co. KG
 Klingenbergstraße 26
 D-32758 Detmold
 Germany

www.weidmueller.com

Technische Daten

Clampable conductor	Cross-section for conductor connection	Type	fine-wired	
		nominal	0.5 mm ²	
	wire end ferrule	Stripping length	nominal	12 mm
		Recommended wire-end ferrule	H0.5/16 OR	
		Stripping length	nominal	10 mm
		Recommended wire-end ferrule	H0.5/10	
	Cross-section for conductor connection	Type	fine-wired	
		nominal	0.75 mm ²	
	wire end ferrule	Stripping length	nominal	12 mm
		Recommended wire-end ferrule	H0.75/16 W	
		Stripping length	nominal	10 mm
		Recommended wire-end ferrule	H0.75/10	
	Cross-section for conductor connection	Type	fine-wired	
		nominal	1 mm ²	
	wire end ferrule	Stripping length	nominal	12 mm
		Recommended wire-end ferrule	H1.0/16D R	
Stripping length		nominal	10 mm	
Recommended wire-end ferrule		H1.0/10		
Cross-section for conductor connection	Type	fine-wired		
	nominal	0.34 mm ²		
wire end ferrule	Stripping length	nominal	10 mm	
	Recommended wire-end ferrule	H0.34/12 TK		

Reference text The outside diameter of the plastic collar should not be larger than the pitch (P), Length of ferrules is to be chosen depending on the product and the rated voltage.

Rated data acc. to IEC

tested acc. to standard	IEC 60664-1, IEC 61984	Rated current, min. number of poles (Tu=20°C)	17.5 A
Rated current, max. number of poles (Tu=20°C)	17.5 A	Rated current, min. number of poles (Tu=40°C)	17.5 A
Rated current, max. number of poles (Tu=40°C)	16.3 A	Rated voltage for surge voltage class / pollution degree II/2	320 V
Rated voltage for surge voltage class / pollution degree III/2	160 V	Rated voltage for surge voltage class / pollution degree III/3	160 V
Rated impulse voltage for surge voltage class/ pollution degree II/2	2.5 kV	Rated impulse voltage for surge voltage class/ pollution degree III/2	2.5 kV
Rated impulse voltage for surge voltage class/ contamination degree III/3	2.5 kV	Short-time withstand current resistance	3 x 1s with 76 A

BCF 3.81/06/180 SN BK BX

Weidmüller Interface GmbH & Co. KG
 Klingenbergstraße 26
 D-32758 Detmold
 Germany

www.weidmueller.com

Technische Daten

Rated data acc. to CSA

Institute (CSA)



Certificate No. (CSA)

200039-1121690

Rated voltage (Use group B / CSA)	300 V
Rated voltage (Use group D / CSA)	300 V
Rated current (Use group C / CSA)	11 A
Wire cross-section, AWG, min.	AWG 26

Rated voltage (Use group C / CSA)	50 V
Rated current (Use group B / CSA)	11 A
Rated current (Use group D / CSA)	11 A
Wire cross-section, AWG, max.	AWG 16

Reference to approval values Specifications are maximum values, details - see approval certificate.

Rated data acc. to UL 1059

Institute (cURus)



Certificate No. (cURus)

E60693

Rated voltage (Use group B / UL 1059)	300 V
Rated current (Use group B / UL 1059)	10 A
Wire cross-section, AWG, min.	AWG 26

Rated voltage (Use group D / UL 1059)	300 V
Rated current (Use group D / UL 1059)	10 A
Wire cross-section, AWG, max.	AWG 16

Reference to approval values Specifications are maximum values, details - see approval certificate.

Packing

Packaging	Box	VPE length	182 mm
VPE width	118 mm	VPE height	22 mm

Type tests

Test: Misengagement (Non-interchangeability)	Test	visual examination
	Evaluation	passed

Classifications

ETIM 6.0	EC002638	ETIM 7.0	EC002638
ETIM 8.0	EC002638	ETIM 9.0	EC002638
ECLASS 9.0	27-44-03-09	ECLASS 9.1	27-44-03-09
ECLASS 10.0	27-44-03-09	ECLASS 11.0	27-46-02-02
ECLASS 12.0	27-46-02-02	ECLASS 13.0	27460202

BCF 3.81/06/180 SN BK BX

Weidmüller Interface GmbH & Co. KG
 Klingenbergstraße 26
 D-32758 Detmold
 Germany

www.weidmueller.com

Technische Daten

Important note

IPC conformity	Conformity: The products are developed, manufactured and delivered according international recognized standards and norms and comply with the assured properties in the data sheet resp. fulfill decorative properties in accordance with IPC-A-610 "Class 2". Further claims on the products can be evaluated on request.
Notes	<ul style="list-style-type: none"> Rated data refer only to the component itself. Clearance and creepage distances to other components are to be designed in accordance with the relevant application standards. Rated current related to rated cross-section & min. No. of poles. P on drawing = pitch Conductors suitable for connection: 1.5 mm² with wire-end ferrule with plastic collar, DIN 46 228/1, with a rated voltage of 125V/2.5 kV with III/3 or 250 V/2.5 kV with II/2 Crimp shape A for wire-end ferrules with crimping tools PZ 1,5 (order no. 9005990000) or PZ 6/5 (order no. 9011460000) for larger wire cross-sections recommended. Wire end ferrule without plastic collar to DIN 46228/1 Wire end ferrule with plastic collar to DIN 46228/4 The test point can only be used as potential-pickup point. In accordance with IEC 61984, OMNIMATE-connectors are connectors without breaking capacity (COC). During designated use, connectors are not allowed to be engaged or disengaged when live or under load Long term storage of the product with average temperature of 50 °C and maximum humidity 70%, 36 months

Approvals

Approvals



ROHS	Conform
UL File Number Search	UL Website
Certificate No. (cURus)	E60693

BCF 3.81/06/180 SN BK BX

Weidmüller Interface GmbH & Co. KG
Klingenbergstraße 26
D-32758 Detmold
Germany

www.weidmueller.com

Technische Daten

Downloads

Approval/Certificate/Document of Conformity	CB Certificate CB Testreport Declaration of the Manufacturer
Engineering Data	CAD data – STEP
User Documentation	BPZL_PUSH_IN_Connectors_BCF_3_81_EN
Catalogues	Catalogues in PDF-format
Brochures	FL DRIVES EN MB DEVICE MANUF. EN FL DRIVES DE FL BUILDING SAFETY EN FL APPL LED LIGHTING EN FLIndustr.CONTROLS EN FL MACHINE SAFETY EN FL HEATING ELECTR EN FL APPL INVERTER EN FL_BASE_STATION_EN FL ELEVATOR EN FL POWER SUPPLY EN FL 72H SAMPLE SER EN PO OMNIMATE EN PO OMNIMATE EN

BCF 3.81/06/180 SN BK BX

Weidmüller Interface GmbH & Co. KG
 Klingenbergstraße 26
 D-32758 Detmold
 Germany

www.weidmueller.com

Zeichnungen

Product image

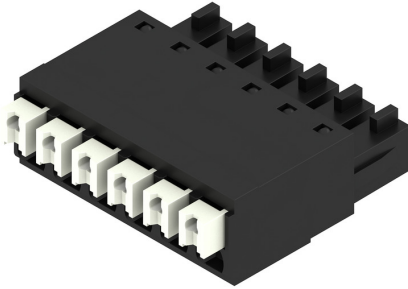

Dimensional drawing

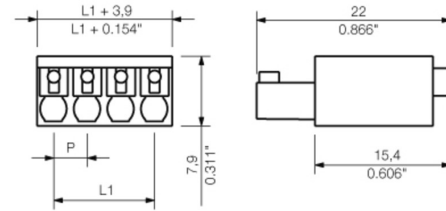

Graph

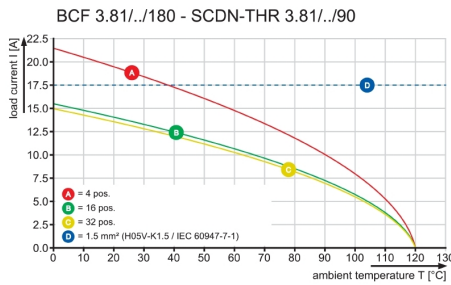

Graph

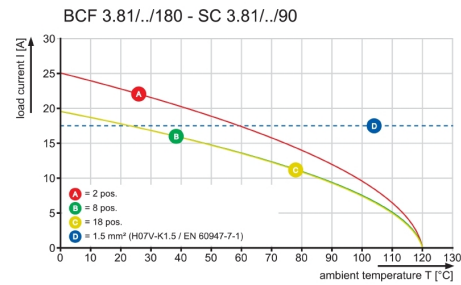

Graph

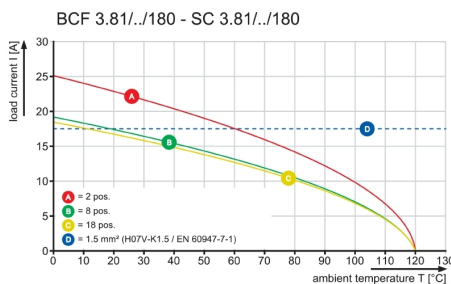

Product benefits

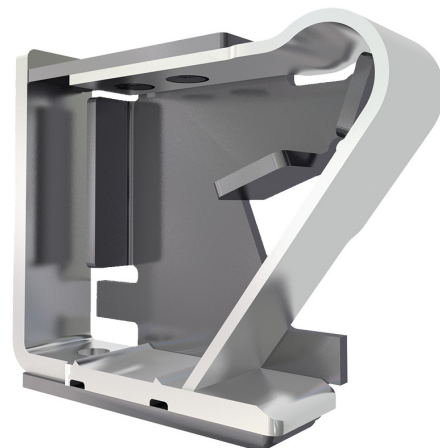

Solid PUSH IN contact
 Safe and durable

MASSE OHNE TOLERANZ SIND KEINE PRUEFMASSE
 DIMS. WITHOUT TOLERANCE ARE NOT CONTROL DIMS.

BCF 3.81/.../180 ... (2,3,4 POLE)

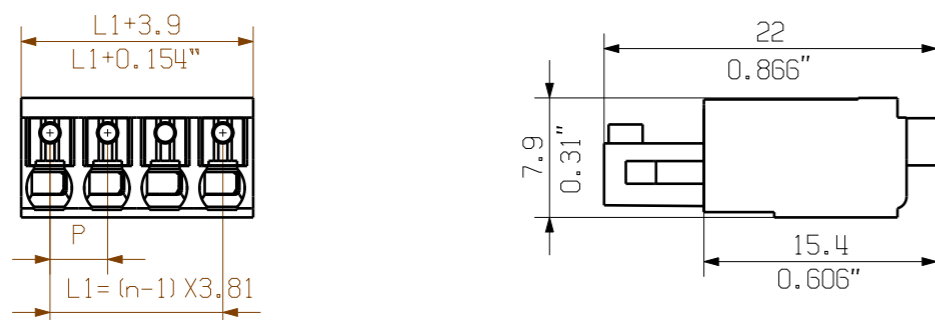

BCF 3.81/.../180LR ...

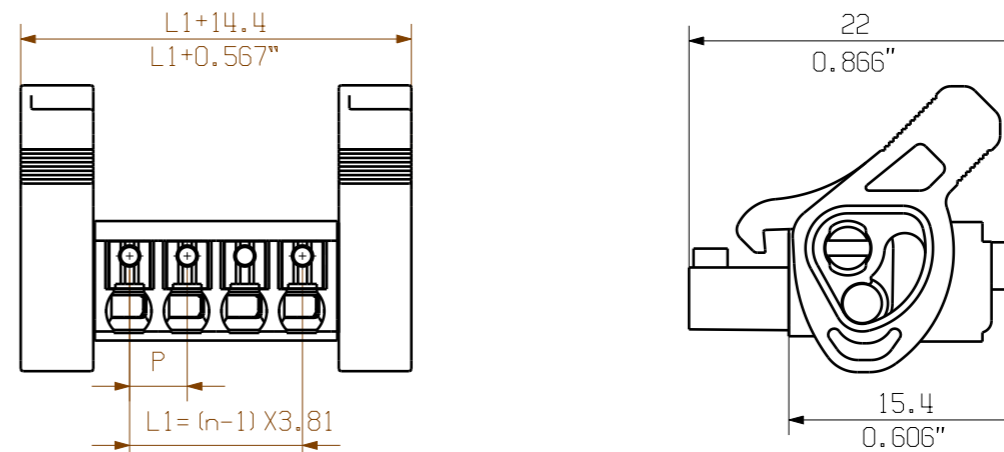

BCF 3.81/.../180 ... (5- 18 POLE)

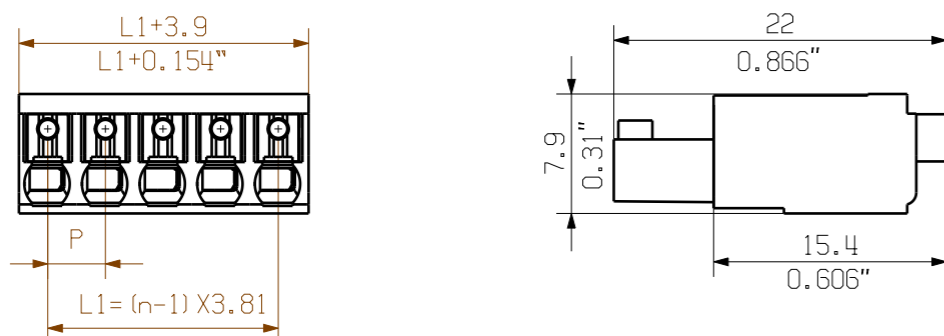

BCF 3.81/.../180F ...

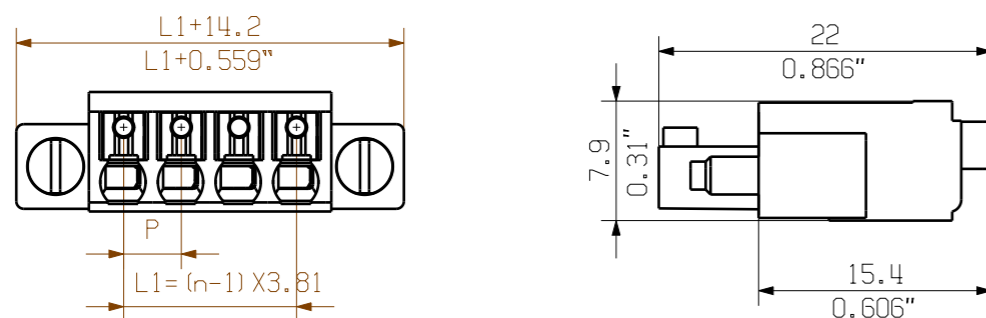

NOTE:

n=NO OF POLES
 P=PITCH

KUNDENZEICHUNG
 CUSTOMER DRAWING

18	64.77	2.550
17	60.96	2.400
16	57.15	2.250
15	53.34	2.100
14	49.53	1.950
13	45.72	1.800
12	41.91	1.650
11	38.10	1.500
10	34.29	1.350
9	30.48	1.200
8	26.67	1.050
7	22.86	0.900
6	19.05	0.750
5	15.24	0.600
4	11.43	0.450
3	7.62	0.300
2	3.81	0.150
n	L1 [mm]	L1 [inch]

For the mounting of PCBs, it should be noted that the rated data given in the catalogue relates only to the connection elements. The necessary creepage and clearance paths must be observed in connection with the respective applicant in accordance to VDE 0110. The current-carrying capacity and pitch tolerance is to be determined according to DIN IEC 326 part 3 very fine.

Weidmüller connectors are tested to the DIN VDE 0627 standard, and are valid for its field of application. Provided that the connectors are used to the intended purpose, all requirements with respect to the occurring of electrical, mechanical, thermic and corrosive stress will be satisfied.

MAX. NRN./NOS. ?		55304/5 18.05.11 GE_G 00		CAT.NO.: .	
MODIFICATION		Weidmüller		C 40414 07	
DRAWN		DATE	NAME	DRAWING NO. SHEET 01 OF 08 SHEETS	
RESPONSIBLE		27.12.2006	XU_S	ISSUE NO.	
CHECKED		03.06.2011	ZHOU_N	BCF 3.81/.../180... SN	
APPROVED			XU_S	BUCHSENLEISTE SOCKET BLOCK	
SCALE: 2/1		PRODUCT FILE: BCF 3.81		7072	
SUPERSEDES: .					

WEITERGABE SOWIE VERVIELFÄLTIGUNG DIESES DOKUMENTS, VERWERTUNG UND MITTEILUNG SEINES INHALTS SIND VERBOTEN, SOWEIT NICHT AUSDRUECKLICH GESTATTET.
 ZUWIDERHANDLUNGEN VERPFLICHTEN ZU SCHADENSERSATZ. ALLE RECHTE FUER DEN FALL DER PATENT-, GEBRAUCHSMUSTER-, ODER GESCHMACKSMUSTEREINTRAGUNG VORBEHALTEN.
 THE REPRODUCTION, DISTRIBUTION AND UTILIZATION OF THIS DOCUMENT AS WELL AS THE COMMUNICATION OF ITS CONTENTS TO OTHERS WITHOUT EXPLICIT AUTHORIZATION IS PROHIBITED.
 OFFENDERS WILL BE HELD LIABLE FOR THE PAYMENT OF DAMAGES. WEIDMUELLER EXCLUSIVELY RESERVES THE RIGHT TO FILE FOR PATENTS, UTILITY MODELS OR DESIGNS.
 WEIDMUELLER INTERFACE GmbH & Co.KG