

SL 5.08HC/04/90G 3.2SN OR BX

Weidmüller Interface GmbH & Co. KG
 Klingenbergstraße 26
 D-32758 Detmold
 Germany

www.weidmueller.com

Product image

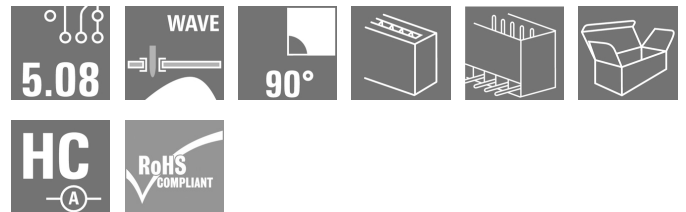

Pin headers made from glass-fibre-reinforced plastic with 90° wire outlet; optimised for wave soldering. The flange variant (F) can be screwed onto the respective counter piece or the circuit board. There is no need for an extra screw to connect the circuit board when the solder flange (LF) version is used. This also protects the solder points from mechanical strain. All pin headers can be manually coded or ordered pre-coded. HC = High Current.

General ordering data

Version	PCB plug-in connector, male header, closed side, THT solder connection, 5.08 mm, Number of poles: 4, 90°, Solder pin length (l): 3.2 mm, tinned, orange, Box
Order No.	1147340000
Type	SL 5.08HC/04/90G 3.2SN OR BX
GTIN (EAN)	4050118051254
Qty.	100 Stück
Product data	IEC: 400 V / 24 A UL: 300 V / 18.5 A
Packaging	Box

Erstellungs-Datum 05 2024, CET 10:36:50 ص ف ب ر ا ي ر

SL 5.08HC/04/90G 3.2SN OR BX

Weidmüller Interface GmbH & Co. KG
 Klingenbergstraße 26
 D-32758 Detmold
 Germany

www.weidmueller.com

Technische Daten

Dimensions and weights

Depth	12 mm	Depth (inches)	0.472 inch
Height	11.63 mm	Height (inches)	0.458 inch
Height of lowest version	8.43 mm	Width	23.52 mm
Width (inches)	0.926 inch	Net weight	1.98 g

System specifications

Product family	OMNIMATE Signal - series BL/SL 5.08	Type of connection	Board connection
Mounting onto the PCB	THT solder connection	Pitch in mm (P)	5.08 mm
Pitch in inches (P)	0.2 "	Outgoing elbow	90°
Number of poles	4	Number of solder pins per pole	1
Solder pin length (l)	3.2 mm	Solder pin length tolerance	+0.1 / -0.3 mm
Solder pin dimensions	d = 1.2 mm, Octagonal	Solder pin dimensions = d tolerance	0 / -0,03 mm
Solder eyelet hole diameter (D)	1.4 mm	Solder eyelet hole diameter tolerance (D)+	0, 1 mm
L1 in mm	15.24 mm	L1 in inches	0.6 "
Number of rows	1	Pin series quantity	1
Touch-safe protection acc. to DIN VDE 57 106	finger-safe unplugged/ back-of-hand-safe plugged	Touch-safe protection acc. to DIN VDE 0470	IP20 plugged/ IP10 unplugged
Protection degree	IP20	Volume resistance	≤5 mΩ
Can be coded	Yes	Plugging cycles	25
Plugging force/pole, max.	10 N	Pulling force/pole, max.	7.5 N

Material data

Insulating material	PA GF	Colour	orange
Colour chart (similar)	RAL 2000	Insulating material group	II
Comparative Tracking Index (CTI)	≥ 550	UL 94 flammability rating	V-0
Contact material	Cu-alloy	Contact surface	tinned
Layer structure of solder connection	1...3 µm Ni / 2...4 µm Sn matt	Layer structure of plug contact	1...3 µm Ni / 2...4 µm Sn matt
Storage temperature, min.	40- °C	Storage temperature, max.	70 °C
Operating temperature, min.	50- °C	Operating temperature, max.	100 °C
Temperature range, installation, min.	25- °C	Temperature range, installation, max.	100 °C

Rated data acc. to IEC

tested acc. to standard	IEC 60664-1, IEC 61984	Rated current, min. number of poles (Tu=20°C)	24 A
Rated current, max. number of poles (Tu=20°C)	19 A	Rated current, min. number of poles (Tu=40°C)	21 A
Rated current, max. number of poles (Tu=40°C)	16.5 A	Rated voltage for surge voltage class / pollution degree II/2	400 V
Rated voltage for surge voltage class / pollution degree III/2	320 V	Rated voltage for surge voltage class / pollution degree III/3	250 V
Rated impulse voltage for surge voltage class/ pollution degree II/2	4 kV	Rated impulse voltage for surge voltage class/ pollution degree III/2	4 kV
Rated impulse voltage for surge voltage class/ contamination degree III/3	4 kV		

Rated data acc. to CSA

Rated voltage (Use group B / CSA)	300 V	Rated voltage (Use group D / CSA)	300 V
Rated current (Use group B / CSA)	18.5 A	Rated current (Use group D / CSA)	10 A

SL 5.08HC/04/90G 3.2SN OR BX

Weidmüller Interface GmbH & Co. KG
 Klingenbergstraße 26
 D-32758 Detmold
 Germany

www.weidmueller.com

Technische Daten

Rated data acc. to UL 1059

Institute (cURus)



Certificate No. (cURus)

E60693

Rated voltage (Use group B / UL 1059) 300 V

Rated voltage (Use group D / UL 1059) 300 V

Rated current (Use group B / UL 1059) 18.5 A

Rated current (Use group D / UL 1059) 10 A

Reference to approval values

Specifications are maximum values, details - see approval certificate.

Packing

Packaging	Box	VPE length	169 mm
VPE width	116 mm	VPE height	38 mm

Classifications

ETIM 6.0	EC002637	ETIM 7.0	EC002637
ETIM 8.0	EC002637	ETIM 9.0	EC002637
ECLASS 9.0	27-44-04-02	ECLASS 9.1	27-44-04-02
ECLASS 10.0	27-44-04-02	ECLASS 11.0	27-46-02-01
ECLASS 12.0	27-46-02-01	ECLASS 13.0	27460201

Important note

IPC conformity

Conformity: The products are developed, manufactured and delivered according international recognized standards and norms and comply with the assured properties in the data sheet resp. fulfill decorative properties in accordance with IPC-A-610 "Class 2". Further claims on the products can be evaluated on request.

Notes

- Additional variants on request
- Gold-plated contact surfaces on request
- Rated current related to rated cross-section & min. No. of poles.
- Diameter of solder eyelet $D = 1.4 + 0.1 \text{ mm}$
- Solder eyelet diameter $D = 1.5 + 0.1 \text{ mm}$, from 9 poles
- P on drawing = pitch
- Rated data refer only to the component itself. Clearance and creepage distances to other components are to be designed in accordance with the relevant application standards.
- In accordance with IEC 61984, OMNIMATE-connectors are connectors without breaking capacity (COC). During designated use, connectors are not allowed to be engaged or disengaged when live or under load
- Long term storage of the product with average temperature of 50 °C and maximum humidity 70%, 36 months

SL 5.08HC/04/90G 3.2SN OR BX

Weidmüller Interface GmbH & Co. KG
 Klingenbergstraße 26
 D-32758 Detmold
 Germany

www.weidmueller.com

Technische Daten

Approvals

Approvals



ROHS	Conform
UL File Number Search	UL Website
Certificate No. (cURus)	E60693

Downloads

Approval/Certificate/Document of Conformity	Declaration of the Manufacturer
Engineering Data	CAD data – STEP
Product Change Notification	EN - Change of packaging DE - Change of packaging
Catalogues	Catalogues in PDF-format
Brochures	FL DRIVES EN MB DEVICE MANUF. EN FL DRIVES DE FL BUILDING SAFETY EN FL APPL LED LIGHTING EN FLIndustr.CONTROLS EN FL MACHINE SAFETY EN FL HEATING ELECTR EN FL APPL INVERTER EN FL_BASE_STATION_EN FL ELEVATOR EN FL POWER SUPPLY EN FL 72H SAMPLE SER EN PO OMNIMATE EN PO OMNIMATE EN

SL 5.08HC/04/90G 3.2SN OR BX

Weidmüller Interface GmbH & Co. KG
 Klingenbergstraße 26
 D-32758 Detmold
 Germany

www.weidmueller.com

Zeichnungen

Product image

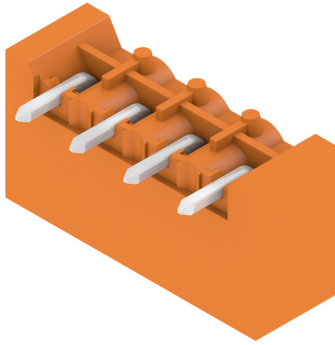

Dimensional drawing

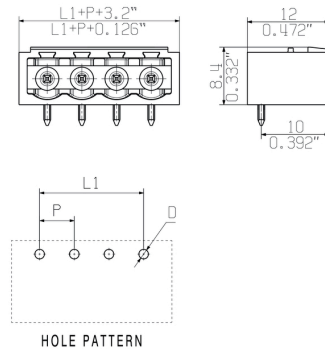

Graph

BLF 5.08HC/./90 - SL 5.08HC/./90

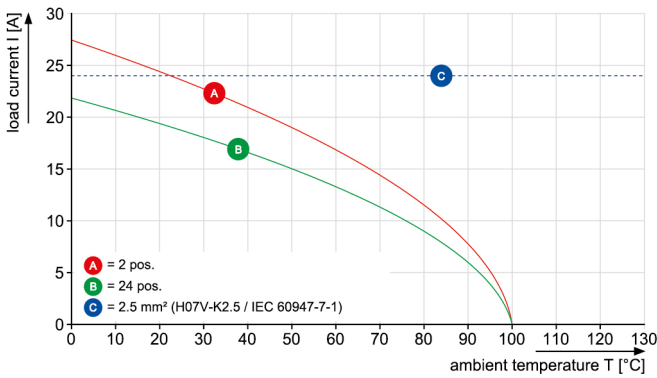

Graph

BLF 5.08HC/./90 - SL 5.08HC/./90

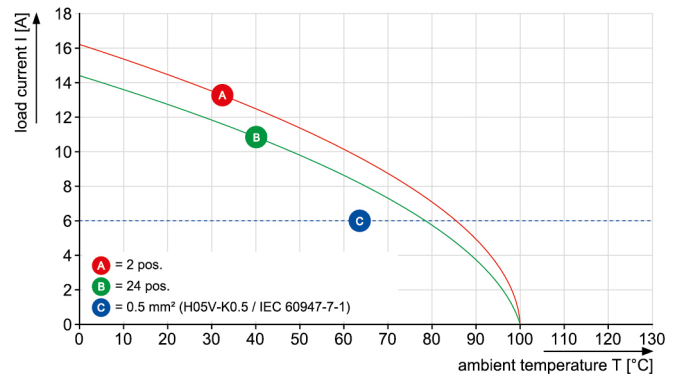

Graph

BLF 5.08HC/./270 - SL 5.08HC/./90

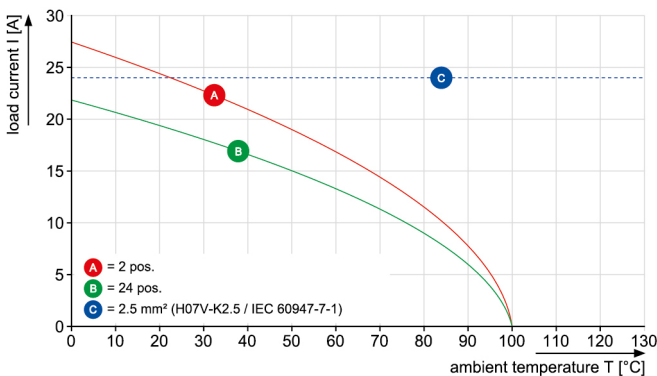

Graph

BLDF 5.08/180 - SL 5.08HC/./90

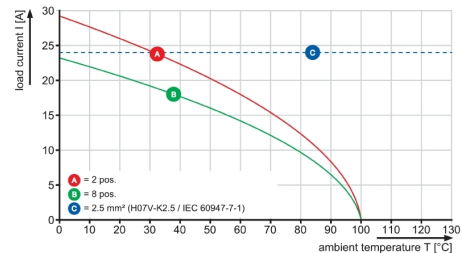

SL 5.08HC/04/90G 3.2SN OR BX

Weidmüller Interface GmbH & Co. KG
Klingenbergstraße 26
D-32758 Detmold
Germany

Zeichnungen

www.weidmueller.com

Graph



Recommended wave soldering profiles

Weidmüller Interface GmbH & Co. KG
 Klängenbergstraße 16
 D-32758 Detmold
 Germany
 Fon: +49 5231 14-0
 Fax: +49 5231 14-292083
 www.weidmueller.com

Single Wave:



Double Wave:



Wave soldering profiles

Wired connection elements should be processed in accordance with the DIN EN 61760-1 standard. We have included two recommendations for practical wave soldering profiles, with which Weidmüller PCB terminals and connectors are qualified.

When choosing a suitable profile for your application, the following factors also need to be considered:

- PCB thickness
- Proportion of Cu in the layers
- Single/double-sided assembly
- Product range
- Heating and cooling rates

The single and double wave profiles each indicate the recommended operating range, including the maximum soldering temperature of 260°C. In practice, the maximum soldering temperature is quite often well below the above maximum profile.