

MACROZOOM

WATERPROOF
MACHINE
LED

PROZOOM®

GREEN-LITE®

MICRO-LITE®

LONGLINE®

GREEN LITE®
O.C. White Co.

ILLUMINATING IDEAS & DESIGNS
Since 1883



These Colors Run Deep...
Proudly American Made
Since 1883





O.C. White® products are the most energy efficient, highest output, longest warrantied, and stylish line of inspection and tasking lighting systems in the world. These exceptionally designed products include important features and benefits available only from O.C. White®. You can only truly appreciate the O.C. White® Advantage in person!

Unrivaled LED Performance

Green-Lite® products use state of the art 'surface mount' LEDs which produce a tremendous amount of light, consume much less power, and last longer due to our exclusive integrated heat-sink technology. Our competition cannot come close to our output or adjustability, due to their use of inferior materials and designs.

Performance can be measured in many different ways. No matter which O.C. White® product you are using, we lead all performance metrics compared to any and all competition. From our exclusive 5 year mechanical warranty, to the extreme output of our Green-Lite® magnifier products, to the sophisticated design of our new LED linear machine light, and everything in between... O.C. White® is the standard.

World Renowned Arm Quality

Our precision quality arms featured on our magnifiers, task lighting, and world famous mic booms used in the broadcast industry, have no equal in the world. They all feature heavy duty extruded aluminum construction, thick stamped steel plates, and specialized music wire springs, which offer an unparalleled ability to hold and glide like no others.

Our competition feature greatly inferior internal spring arm designs, which squeak, droop, and cannot be tightened or serviced at all. Our designs are able to be tightened for silent, precision holding at any angle, and are completely rebuildable with simple hand tools. This is particularly important for our broadcast customers... when you are on the air, they must hold steady and be silent! These exceptional arms, just like the models used in our lighting fixtures, hold up more weight than any other in the world, without wavering. This is the key to why we can offer the largest magnifying lenses in the world.

Faster Return on Investment

Your investment in our Green-Lite® LED technology quickly pays for itself through lower operating costs, long lifespans, and improved productivity. A lower total cost of ownership provides the greenest solution of all! Our 6" Green-Lite® LED magnifier consumes only 4W of power at high (and even less when dimmed), making it the world's most energy efficient spring arm magnifier. Our Micro-Lite® LV2000 illuminator series can equal or exceed the light output of a 150W halogen fiber optic light, while using only 8W at high!

What It Means to be Made in the USA

O.C. White® is not only the world's oldest industrial lighting company, but we have been proudly manufacturing here in the United States since 1883. Our success stems from the simple formula of utilizing the highest quality components, the most advanced technical designs, and using quality American craftsmen to create the highest quality inspection and task lighting products anywhere in the world. All products are hand built, one at a time, to deliver the highest quality every time.

Our manufacturing and corporate offices are located in Thorndike, MA, and reside in a 100,000 sq.ft. fully restored 1920s-era brick mill building. Utilizing all 6 stories, our manufacturing, R&D, and corporate offices stand tall over the surrounding area. We take great pride in being able to not only manufacture the highest quality products possible, but also by the hands of American craftsmen. When you take pride in what you do, it shows.

We thank each and every one of you for experiencing the O.C. White® Advantage!



Made in the U.S.A.

O.C. White® High Intensity



American Made – Since 1883!

The O.C. White® High Intensity LED Linear machine light represents the pinnacle of American made quality, sleek design, and outstanding performance.

The solid die-cast aluminum body construction is for more than just show! It is an integral feature of this light, acting as the heat sink for the LED arrays. This light also features tempered safety glass and a slim, nickel plated bezel. It is engineered to withstand even the harshest conditions. Unlike the plastic and thin-walled extrusions our competitors use, this light is made to last a lifetime.

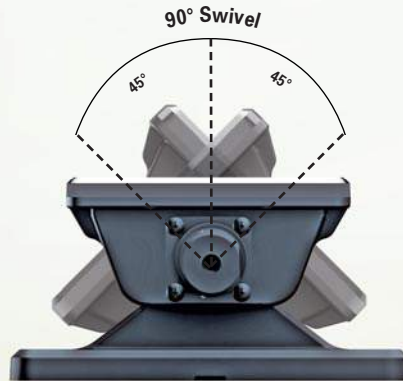

Adjustable To Any Angle

You can adjust the light 90° (45° in each direction). This opens up limitless installation possibilities, while still putting the light exactly where you want it.

LED-1936-2-24V

Shown in a Weldon Solutions Solaris Large Capacity OD Grinder

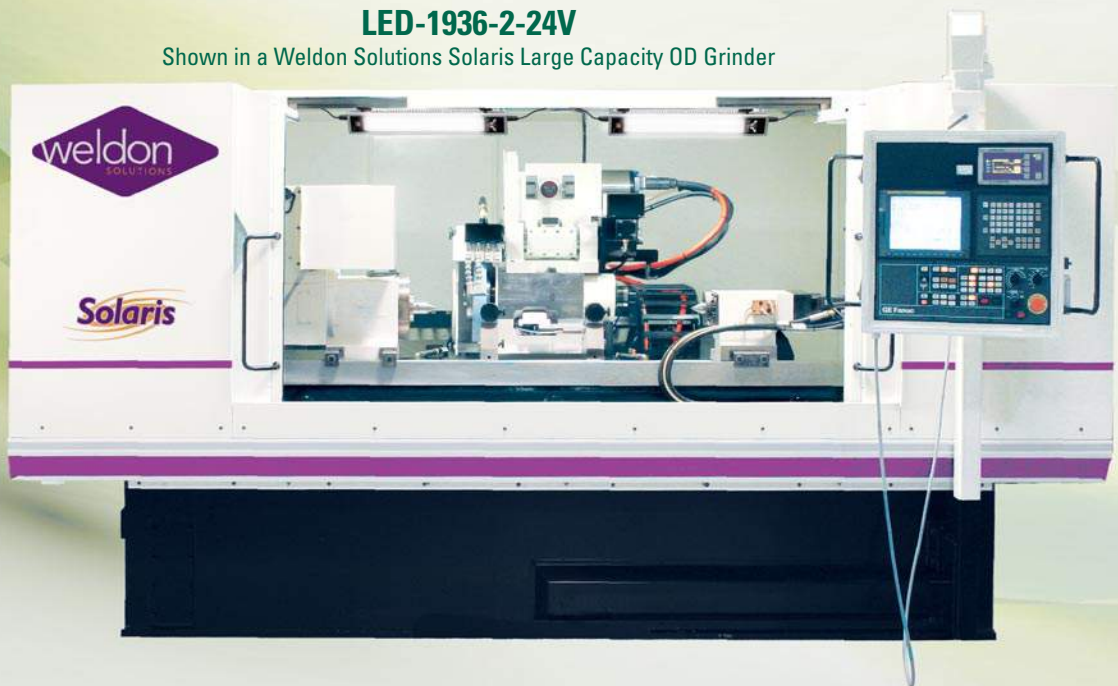

Smart Phone Enabled

LED Machine Task Light



Underside of magnetic foot

“Green” Long Before It Was Fashionable

Overheating is the leading cause of premature LED burnout. One of the most advanced features of the O.C. White® Linear LED is the “Patent Pending” thermal dimming controls. If the light exceeds our maximum temperature threshold, it will automatically dim itself to cool down, which greatly extends its service life.

Also due to our best-in-class engineering, O.C. White® Linear LED fixtures have **TWICE** the light output from the same wattage compared to our competition, and greatly exceed the old style fluorescent lights.

LED-1936-UTL
(2) O.C. White® LED Universal Task Lights shown on a Sovella® TL Advantage™ workstation



Worldwide Appeal

This light can be used on virtually any machine, or in any enclosure across the world. You decide between 24VDC (hardwired) or one of our 100-240V (50/60hz) worldwide approved transformers.

Exclusive Quick Magnetic Mount or Permanent Installation

With O.C. White®, the choice is yours. Both mounting feet come complete with a pair of high strength rare earth Neodymium magnets preinstalled at the factory. These allow for a quick magnet mount installation anywhere. Each lighting fixture also includes (4) countersunk screw holes for permanent installation.

Universal Task Lighting

A specialized version of our LED machine light; this model features an on-board dimming switch to allow for ultimate lighting control. This light is at home under a work bench shelf, or mounted anywhere by the strong Neodymium magnetic feet.



Limitless Installation Possibilities

The specialized design of the O.C. White® High Intensity Linear LED machine light allows for up to (3) lighting fixtures to be run from a single power point. This drastically reduces wire clutter and affords a much faster installation.

You can now illuminate even the largest enclosures with ease.



LED-1936-2-120V

(2) O.C. White® LED Machine Lights with Interconnect Cable and 100-240V Power Supply



All models shown are Made in the U.S.A.



Smart Phone Enabled

Green-Lite®

Greatest Illuminated

Equipped with next generation, surface mount LEDs, these innovative designs create the new standard for illuminated magnifiers.

**Patented
#D656527
Other Patents
Pending**

**7" x 5.25"
Rectangular
UV LED Green-Lite®**



82400-4-UV-B
(Shown in Carbon Black)

**7.5" Round
LED Big Eye™
Green-Lite®**



62400-4-SB
(Shown in Spectre Blue finish)

**7" x 5.25"
Rectangular
LED Green-Lite®**



82400-4-BR
(Shown in Blaze Red finish)



Lighting Features

- Combination (8) White light LEDs & (4) **Ultraviolet (395nm)** LEDs now available in Rectangular models
- Rectangle and Big Eye™ Models feature 12 LEDs while 6" and 5" Round models feature 6 LEDs
- 6" available in 12 LED configuration (optional)
- Over 4x the lumen output of a standard magnifier
- Reduced glare, heat and energy consumption
- Multi-angle LEDs for shadowless lighting at a full range of focal lengths and heights
- User controlled LED groups shine desired level of light exactly where required
- Superb dimming software via convenient, reliable membrane switch
- Built in energy management system & lighting timer

Optical Features

- 12 pc. optional frosted diffuser kit for Rectangle and Big Eye™ Green-Lite® magnifiers (#13225)
- 6 pc. optional frosted diffuser kit for 6" and 5" Green-Lite® magnifiers (#13226)
- Precision ground, crown white optical grade glass provides the highest image resolution
- Largest lenses in the industry
- Standard 4 Diopter (2x) lens – **O.C. White® exclusive!**
- Optional 5 Diopter (2.25x) lens on round models
- Four lens sizes to choose from
 - 7" x 5.25" rectangle
 - 7.5" round
 - 6" round has a **44% larger** viewing area than a 5" model
 - 5" round

LED Magnifiers

Magnifiers in the World

NEW

6" Round Handheld LED Green-Lite®



40000-4-BY
(Shown in Blazing Yellow)
Also Available in Ultraviolet

Your investment in new technology quickly pays for itself through energy savings. **Proudly Made in the USA.**



6" Round LED Green-Lite®

42400-4-12-S
Special 12 LED configuration
(Shown in Silver finish)



6" Round LED Green-Lite®

42400-4
Standard 6 LED configuration
(Shown in Shadow White)



5" Round LED Green-Lite®

22400-4-RG
(Shown in Racing Green)

NEW



Electrical Features

- Extremely safe, low voltage (7.5 and 15v) power supplies are auto-switchable with worldwide approvals
- IEC plug design allows for simple plug-and-play cord change anywhere in the world
- Auto shut off at 4 hour, 5 minute intervals to prevent energy waste while users are away (user activated after delivery)

Mechanical Features

- High quality die cast aluminum shades and all metal components for ESD safety
- Patented "Elite" arms are sleek but have the greatest holding power of any arm of this type in the world
- Standard 43" arm reach (25" arm reach available)



11426
(Wall Mount)

11427-B
(Screw Down Base)

11440-1B
(Table Edge Clamp)

11458-B
(Weighted Base)

11469
(Heavy Duty Roll Around Base)

Warranty

- 5 years/50,000 hour pro-rated LED life
- Made in the USA with **5 Year Mechanical Warranty Best in the Business Since 1883**

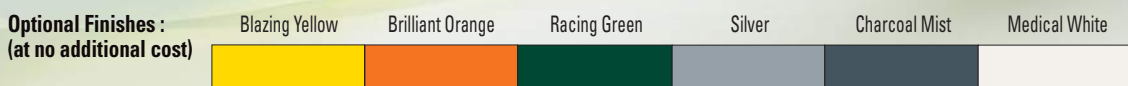
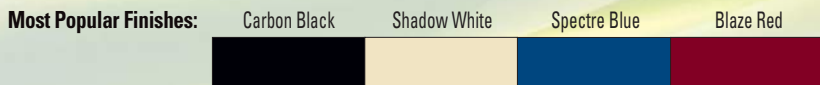

All models shown are Made in the U.S.A.

Patented
#5,757,142

Vision-Lite® High Output Dimmable Fluorescent Magnifier

The world's largest and clearest magnifier on the market features excellent image clarity, lighting control and energy efficiency. The Vision-Lite® is the world's first and only patented dimmable fluorescent illuminated magnifier. **Proudly Made in the USA.**



71600
(Shown in Shadow White
with optional 10 Diopter
Swing-a-way lens)



72400-B
(Shown in Carbon Black)



All models shown are
Made in the U.S.A.

- **ESD safe**
- 7.5" x 6.25", 3 Diopter (1.75x) TRUE rectangular lens with zero distortion
- 100-25% dimming range
- Crown white, optical grade glass lenses provide the highest resolution images for precision inspection
- **Ultraviolet** bulb (P/N 13393) available
- Table edge clamp standard with screw down or weighted base options available
- Also available in all Green-Lite® colors at **no extra charge!**
- Made in the USA with **5 Year Mechanical Warranty**
Best in the Business Since 1883



Smart Phone Enabled



Smart Phone Enabled

Magnilite® 5" Fluorescent Illuminated Magnifier

Our industry standard 5" Magnilite®! This American made, ESD safe magnifier has been the industry standard since the late 1950s. It has a high output, 22 watt circular bulb, which provides crisp, even illumination. Standard magnification of 3 Diopter (1.75x) as well as optional 5 Diopter (2.25x) available. **Proudly Made in the USA.**



30800
5" Halo Magnilite®
(Shown in Shadow White)



32400
5" Magnilite®
(Shown in Shadow White)

- ESD safe
- 22 watt FC8T9 bulb provides large area of light
- Crown white optical grade, 5" round lens
- 3 Diopter (1.75x) standard with 5 Diopter (2.25x) available
- Table edge clamp standard with other mounting options available
- Made in the USA with **5 Year Mechanical Warranty Best in the Business Since 1883**



All models shown are Made in the U.S.A.



Big Eye™ T5 Fluorescent Magnifier

Our famous Big Eye™ is one of our largest Magnilite® models! The crystal clear 7.5" diameter lens is made of optical quality glass. Configured standard with our new 4 Diopter (2x) lens, but also available with a 5 Diopter (2.25x) optical quality lens. The Big Eye™ has all metal construction, which affords ESD safety by design. The slim, hand spun aluminum shade provides low profile viewing, with superb weight savings. **Proudly Made in the USA.**

- ESD safe
- Crown white optical grade, 7.5" round lens for highest resolution images
- 4 Diopter (2x) standard, 5 Diopter (2.25x) optional **O.C. White® exclusive!**
- Shadowless 10", slim T5 bulb for uniform lighting at any level
- Table edge clamp standard with other mounting options available
- Made in the USA with **5 Year Mechanical Warranty Best in the Business Since 1883**



52400-4
7.5" Big Eye™
(Shown in Shadow White)



Smart Phone Enabled



Smart Phone Enabled

Longline™ Task Lighting



Our fluorescent double tube, 30 watt draftsman style task light, has set the standard for years in quality and function. A superior grade steel shade & adjustable swivel assembly provide users a rugged but stylish, task light available with either standard cool white bulbs (#13369), or our optional **ultraviolet** (#13391). Two-15 watt cool white bulbs included unless otherwise specified. Protective safety caps available (#13544-4).

Our 43" long Ultraflex® arm is adjustable to a variety of angles. Table edge clamp standard, other mounting options available. 120V only. **Proudly Made in the USA.**

- ESD safe
- Rigid steel twin tube shade for long life
- Two-15 watt cool white bulbs included
- 43" Ultraflex® arm
- Table Edge Clamp standard with other mounting options available
- Made in the USA with **5 Year Mechanical Warranty Best in the Business Since 1883**



20700
Longline™ Task Lighting
(Shown in Shadow White)



All models shown are Made in the U.S.A.



25800
Heavy Duty Task Lighting
(Shown in Shadow White)

Heavy Duty Task Lighting

This rugged yet economical task light has provided reliable lighting to industry since the 1950s. It features a hand spun aluminum, 8" diameter vented shade with a bright white inner liner. The robust 43" armature has no equal in the world for reliability and sturdiness. It features a high quality ceramic socket, and can accept most modern incandescent, compact fluorescent, or LED light bulbs. Table Edge clamp is included standard, but other mounting options are available. 120V Only. **Proudly Made in the USA.**

- ESD safe
- Bright white inner liner
- 8" Spun Aluminum vented shade for cooler precision light placement
- 43" Ultraflex® arm
- Made in the USA with **5 Year Mechanical Warranty Best in the Business Since 1883**



Smart Phone Enabled



Smart Phone Enabled

550 CFM Fume Extraction Fan

For welding or large fume removal jobs, our 550 CFM unit blows them all away. UL/CSA fan and finger guards provide excellent protection. Fan may be adjusted to move air in either direction.

Mounted on our 43" long Ultraflex® arms for dependability, strength and easy movement. **Proudly Made in the USA.**

- 550 CFM fan UL/CSA
- Heavy cast 10" fan housing
- 43" Ultraflex® arm
- Table Edge Clamp standard with other mounting options available
- Made in the USA with **5 Year Mechanical Warranty Best in the Business Since 1883**



All models shown are Made in the U.S.A.



50010
550 CFM Fume Extraction Fan
(Shown in Carbon Black)



50020
Fume Absorber Fan
(Shown in Carbon Black)

Exhaust Fan

Our newest Exhaust Fan combines both fume removal from the work area and a carbon activated filter. Flux fumes are also noxious fumes, causing headaches, nausea and eye irritation. The health benefits of clean air should not be overlooked in today's manufacturing environment.

This unit may be positioned easily from either side to keep your work area fume free and uncluttered. Mounted on our 43" long Ultraflex® arms for dependability, strength and easy movement. **Proudly Made in the USA.**

- 5" 100 CFM fan UL/CSA
- Square, steel ESD shade
- 43" Ultraflex® arm
- Table Edge Clamp standard with other mounting options available
- ESD safe
- Carbon activated filter included
- Five pack replacement filter kit available (P/N A1001)
- Made in the USA with **5 Year Mechanical Warranty Best in the Business Since 1883**



Smart Phone Enabled

MacroZoom High Definition

NEW 5 Megapixel (2560x1920) USB3 camera

The MacroZoom Video Inspection packages are uniquely qualified to inspect anything. This specialized lens system afford both high magnification, (up to 80x) as well as the unique ability to allow for 12+” of working distance. You cannot find such versatility anywhere else.

Our new exclusive design is also available optionally with a large Windows 8 tablet for the most exciting and well equipped inspection system ever offered! Along with real time streaming video, you can also utilize our Image Acquisition & Measurement software right at the machine. This means that you can capture still images and video, measure, and a whole host of other options... and send your captures to vendors or customers right off the manufacturing floor via wireless internet connection! This camera can also be connected to any PC with a USB3 port.

Exclusive Camera Features

- 5 Megapixel USB3 (2560x1920)
- Real Time Video with no lag - 60fps
- Excellent Color reproduction
- Power over USB - No power supply needed

Exclusive Tablet Features

- Active Matrix TFT Color LCD (LED Backlit)
- Full HD Screen (1920x1080)
- Touchscreen Keyboard
- IEEE 802.11a/b/g/n wireless LAN



TKDMACZ-5MP-TAB-LV2

MacroZoom on 24” Ball Bearing Base with
5MP Camera, Integrated Tablet & LED Ring Light



Smart Phone Enabled

Video Inspection Systems

that streams a full 5 MP @ 60 frames a second!

Our variable focal lens system allows for 'on the fly' focus adjustment. Simply position the lens at the exact working distance you require, and with a simple turn of the lower focal body, your lens is focused for precision inspection. Constructed with an adjustable aperture control, not only does this lens excel in low light situations, it can also be adjusted for increased contrast and reduced glare.

Included standard with this package is our 'close up' (under 12" WD) lens. At distances above 12", you simply remove the 'close up' lens from the lower side of the package, and you can use ambient light for its illumination. With our sophisticated imaging accessories, you are assured quality images every time.

NEW USB3 Digital Imaging Packages

You now have a choice between our standard 2MP (1600x1200) USB 2.0 camera or our **NEW** 5MP (2560x1920) USB3 Digital Camera. Both cameras ship complete with our Image Acquisition & Measurement Suite. The 2MP USB 2.0 camera is our standard model with 14fps performance. The **NEW** 5MP camera runs at **60fps at full 5MP resolution!** You now do not have to choose between the ability to capture & measure, or have a smooth, lag-free image... our 5MP model does both!

Past the powerful specifications of our cameras, the heart of the digital imaging package is our user friendly Image Acquisition & Measurement Suite. Including standard with either resolution digital camera, this suite features a very intuitive user interface, and has a host of standard features:

- Still Image and Video Capture
- Image overlay with adjustable transparency
- CAD file import for layout comparison
- Measurement (featuring 13 measurement parameters)
- On Screen Reticle with full calibration performance extending six decimal places
- On Screen Annotation and Symbol Placement
- Split Screen Capability as well as Picture-in-Picture functionality



TKDMACZ-5MP-LV2

MacroZoom on 24" Ball Bearing Base with 5MP Camera & LED Ring Light



TKMACZ-LV2

MacroZoom on 24" Ball Bearing Base with HD1080p Camera, 22" Screen & LED Ring Light

NEW HD1080p HDMI High Definition Packages

If you are looking for the perfect free standing inspection system, this is it. This MacroZoom system is offered with our industry exclusive **HD1080p** High Definition HDMI camera. This model has superb sensitivity and color rendition, which allows for use with no light at all under many uses - no longer do you have to fight glare!

We pair our sleek and energy-efficient 22" HD LED monitor with this camera for the best combination of real time performance, clarity and energy efficiency. No computer needed. Never settle for anything but the best...O.C.White.

Exclusive ESD Safe Ergonomically

Our newest family of microscopes, the Ergo-Zoom® series utilizes a common main objective optical design. Standard models are paired exclusively with ergonomically adjustable eyepieces!



Smart Phone Enabled



Adjustable Ergo-Zoom® Stereo-Zoom

TKEZ-850-LV2

Ergo-Zoom® 8-50x Package on Ball Bearing Base & LV2000-B LED Ring Light

The Ergo-Zoom® series from O.C. White® is setting the new standard for inspection performance. The Ergo-Zoom® series comes in three magnification levels, and is completely modular so accessories can be added as you see fit.

Our Ergo-Zoom® series is based around a common main objective optical design, which offers a crisper, distortion free image, as well as a much flatter field of view. The end result is the highest quality image you can achieve out of a microscope. Combine these excellent optical characteristics with the ergonomic adjustment, and large range of features, and you have a microscope series that is at home in any industry.

O.C. White® exclusively offers ergonomically adjustable eyepieces standard. The eyepieces are adjustable from 0 to 35° on the fly, and are usable anywhere in between. This adjustment allows for total microscope manipulation.



Angular Adjustment Standard on all Ergo-Zoom® Microscopes

Adjustable Microscope Systems

No one else can bring you such value, performance, and versatility, all in one package... at an extremely competitive price!

- ESD Safe and RoHS Compliant
- Eyepieces adjust from 0 to 35° on the fly for total comfort
- Ideal for operators who use a microscope all day long
- Three standard magnification zoom levels (with 1x lens):
 - EZ-850 8-50x Mag. (up to 200x with options)**
 - EZ-864 8-64x Mag. (up to 256x with options)**
 - EZ-880 8-80x Mag. (up to 320x with options)**
- Large selection of eyepiece and objective options
- Dual ball bearing glide arms provide smooth movement and precise placement
- Striking matte black ESD safe coating
- Can be configured as standard binocular, trinocular, or dual trinocular microscope due to modular CMO design
- 2MP USB 2.0 (1600x1200) and **HD1080p** imaging packages available
- Unequaled quality at a very reasonable cost
- 5 Year Mechanical Warranty



Fixed Ergo-Zoom® Stereo-Zoom



TKEZ-850-FH-LV2
Fixed Ergo-Zoom® 8-50x Package
on Ball Bearing Base &
LV2000-B LED Ring Light



Fixed 20° extended length
eyepiece tubes for ergonomic comfort

The Ergo-Zoom® series comes in three standard magnification levels; **8-50x**, **8-64x**, and **8-80x**. Optional eyepieces and objectives are available to increase these ranges up to **320x**. As this microscope series is modular, any of the three microscope configurations can be converted into a trinocular microscope with the addition of the EZ-Splitter. No longer is your microscope 'obsolete' when you need to expand the microscope's capabilities!

Also available with this series is the new fixed 20° eyepiece head. The combination of long eyepiece tubes, and shallow angle, provide superb ergonomic comfort and performance. No other microscope series affords such functionality and interchangeability options.

Ergo-Zoom® Trinocular Microscope Systems

No longer is your microscope 'obsolete' if you decide to add video inspection capabilities down the road. With choice of single or dual monitor support, the Ergo-Zoom® series is the most flexible on the market!

Only the highest quality digital cameras will work with microscopes of this caliber. O.C. White® offers two digital camera choices, each featuring a sophisticated, yet easy to use interface. The USB 2.0 digital camera is 2 Megapixel (1600x1200). The small form factor of our cameras allows for maximum clearance beneath above-bench shelving, and simple plug and play design allows for near universal installation on any PC or laptop.

Past the powerful specifications of our cameras, the heart of the digital inspection package is our user friendly Image Acquisition and Measurement software suite.

Included standard with either resolution digital camera, this suite features a very intuitive user interface, and has a host of standard features:

- Still Image and Video Capture
- CAD File import for layout comparison
- Measurement (featuring 13 measurement parameters)
- Image overlay with adjustable transparency



TKDEZT-850-TAB-LV2

Ergo-Zoom® Digital Package on Ball Bearing Base with 2MP Camera, Integrated Tablet & LV2000-B LED Ring light

- On Screen Reticle with full calibration performance extending six decimal places
- On Screen Annotation and Symbol placement
- Split Screen capability as well as Picture-in-Picture functionality



TKEZT-850-FH-LV2

NEW HD1080p Ergo-Zoom® Package with 22" HD LED Monitor on Ball Bearing Base & LV2000-B LED Ring Light



Smart Phone Enabled

For production use, the **NEW HD1080p** Inspection pairs our **industry exclusive** High Definition 1080p digital camera with a sleek 22" HD LED monitor. No other manufacturer offers such a high resolution camera for real time inspection. Video is passed over HDMI to our exclusive energy saving LED monitor. Available on both traditional Ergo-Zoom® and fixed 20° models.

Ergo-Zoom® Microscope Configuration Chart

Mounting Bases

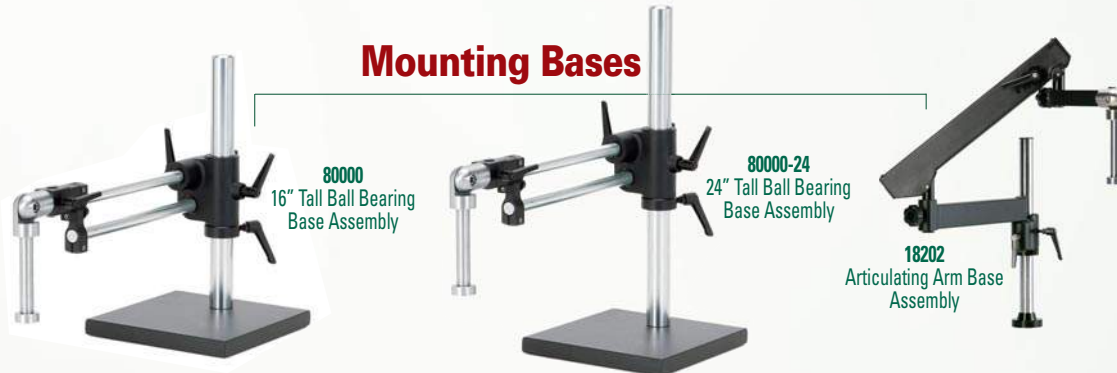

Optical Components



Imaging Accessories

Please Consult Factory for Imaging Options

Illumination

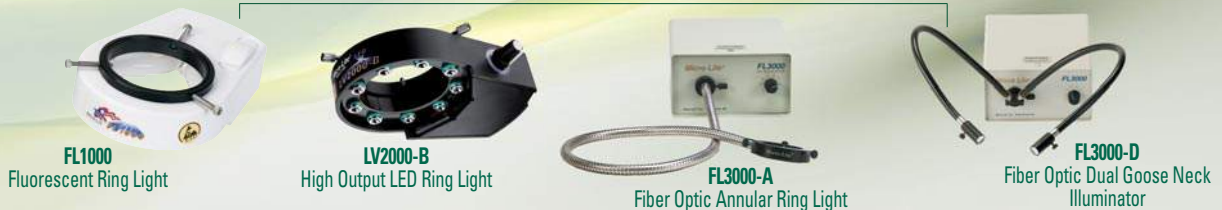



Smart Phone Enabled

High Performance ESD Safe

OC White ProZoom® 6.5 Microscopes

The ProZoom® 6.5 family of microscopes provides the largest standard working distance, largest magnification range, and largest eyepieces available on a stereo zoom microscope. The ProZoom® 6.5 microscopes outperform the competition, even those at double the cost or more! There truly is no equal.



INCLUDES FREE
.5x lens (\$125 Value)

TKPZ-LV2
ProZoom® 6.5 Binocular
Package on Ball Bearing Base
& LV2000-B LED Ring Light

The ProZoom® 6.5 series of Binocular and Trinocular microscopes are the highest performing stereo microscopes on the market. With a standard magnification range of **5-65x**, and an optional range of up to **390x**, there is no inspection task this microscope can't tackle. Due to the design, it is also affords the largest standard working distance from any manufacturer. Our trinocular model, PZT-6.5 is a "true" trinocular. What this means is that you do not lose any functionality of eyepieces when using the video port. Low end competition force you to choose... both eyepieces or one eyepiece and video.

The ESD safe design of this microscope is due to all metal construction. Many microscopes include molded plastic components, or topical ESD coatings that will degrade over time. The ProZoom® 6.5 series is ESD safe by construction, and will stay ESD safe over its lifetime.

- Standard magnification range **5-65x** (up to **390x** with options)
- Super wide 28mm high eye point and wide field eyepiece
- Eye tube inclination of 45°, and main body can be rotated 360° in holder
- 190mm of working distance with .5x objective lens
- ±6 Diopter adjustments on eyepiece tubes
- Interpupillary distance adjustment range is 52mm~76mm
- Microscope and base assembly features rugged all metal construction for ESD safety
- Trinocular package includes .3x CCD adapter
- 2MP USB 2.0 (1600x1200) and **HD1080p** imaging packages available
- Heavy duty ball bearing glide arm base assembly standard
- 5 Year Mechanical Warranty, 1 Year Electrical/Video Warranty

Microscope Systems



Smart Phone Enabled



NEW ProZoom® 6.5 **HD1080p** Package with 22" HD LED Monitor on Ball Bearing Base & LV2000-B LED Ring Light

For all trinocular models, we offer a choice of our **industry exclusive HD1080p** High Definition or 2MP USB 2.0 Digital Imaging packages. Our **NEW** High Definition 1080p digital camera comes paired with our new, sleek 22" HD LED monitor for both high performance real time imaging, and low energy use. This real-time viewing package affords not only high definition imaging, but also superb color rendition and contrast detail for clarity that cannot be matched.

Our 2 Megapixel (1600x1200) USB2 camera with Image Acquisition & Measurement Software Suite compliments the line. It is an excellent choice for quality analysis engineers or end of line documentation. The software features image and video capture, measurement, picture-in-picture, CAD file image overlay, and an on screen reticle which can be calibrated to six decimal places. Whichever way you go, you are sure to get incredible performance, for an incredible price.



Smart Phone Enabled



TKDPZT-TAB-LV2
ProZoom® Digital Trinocular Package on Ball Bearing Base with 2MP Camera, Integrated Tablet & LV2000-B LED Ring Light

ProZoom® 4.5 Microscopes

The ProZoom® 4.5 family of microscopes combine durability, performance, and low cost in a way that can only truly be appreciated when used... and used hard! This workhorse of a microscope has all of the magnification performance of much more expensive microscopes, with the rugged dependability that we have hung our hat on for over 130 years.

Standard throughout all O.C. White® microscope packages is our heavy duty, double ball bearing arm base assembly. This rugged piece provides effortless motion across the work surface, while maintaining pinpoint accuracy once locked.

The ProZoom® 4.5 series from O.C. White® has a standard magnification range of 7-45x, ESD safety, and a robust build that rivals much more expensive microscopes. With optional lenses and eyepieces, this microscope series can reach up to 225x. With incredible reliability, many optional lenses available, and numerous configurations, you are tough pressed to find a configuration that won't fit your needs.



TKSZ-LV2
ProZoom® 4.5 Binocular
Package on Ball Bearing Base
& LV2000-B LED Ring Light

INCLUDES FREE
.5x lens (\$125 Value)

- Standard magnification range 3.5x - 45x
- 3.5x - 225x range with available options
- Superb large 22mm 10x eyepieces
- .5x objective lens included standard
- Excellent resolution
- 90-250mm working distance depending on objective used
- ±5 Diopter adjustments on eyepiece tubes for ultimate clarity
- Eye tube inclination of 45°, and main body can be rotated 360° in holder
- Rugged all metal construction for **ESD safety**
- Heavy duty ball bearing arm base assembly standard
- 5 Year Mechanical Warranty



TKSZ-L-LV2
ProZoom® 4.5 Binocular Package
on Laboratory Style Base &
LV2000-B LED Ring Light



Smart Phone Enabled



Smart Phone Enabled

BONKOTE

A M E R I C A , I N C .

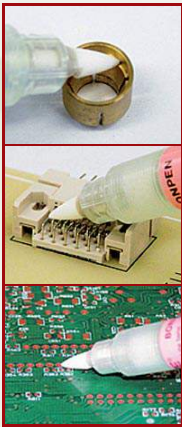

These new handy Bon Pens allow for very accurate flux dispensing on the work area, while eliminating dripping and flooding. You have total control at your finger tips, unlike all of the messy dispensing bottles on the market. **Made in Japan.**

Very easily cleaned and maintained with alcohol or water, depending on Flux use.

- Re-usable flux applicator
- Used with non-wash, wash or strong acid flux
- Replaceable tips & cartridge
- Excellent for spot soldering on IC chips
- Low cost, 7CC capacity
- All units sold in 5 packs
- Fine point or broad point
- Flexible shafts
- Controlled application/no mess



Replacement Tips for Pens Below



CA-102
Replacement
Cartridge

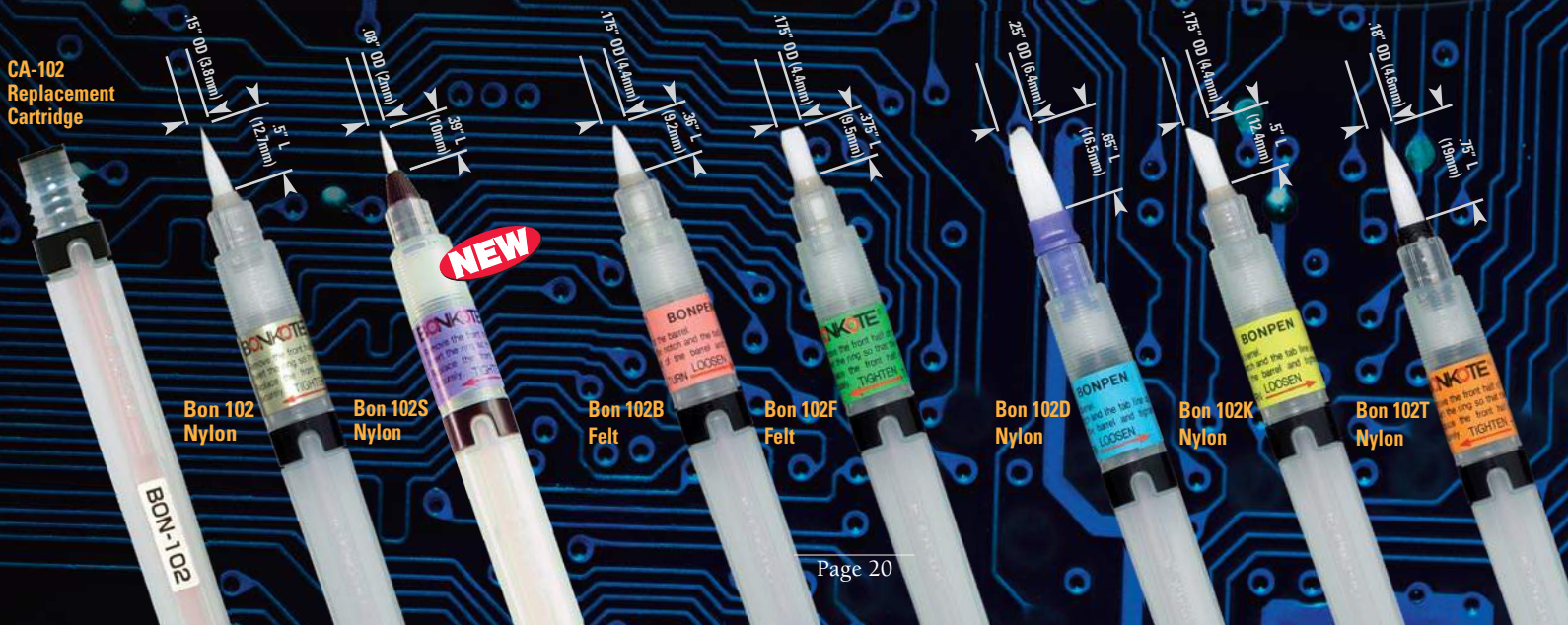

Micro-Lite® American Made



LV2000



LV2000-B

Micro-Lite® LED Illumination

Perfection? We think so. Our LV2000 solves three of the biggest complaints about microscope illumination... long life span, low operating costs, high lumen output. Combined with the fact that it is ESD Safe, there is no reason to buy any other LED ring light! **Proudly Made in the USA.**

The Micro-Lite® LV2000-B (Black) is our newest ring illuminator. It features the newest surface mount LED technology that is paired with our exclusive design criteria, to make the highest performance, longest operating, lowest cost LED ring illuminator sold today! The days of having to buy replacement bulbs are a thing of the past!

Our ESD Safe LV2000 series features instant-on performance, with zero flicker. It is fully dimmable, from 100-5%, with an integrated dimming switch on the shade. Our exclusive design also allows for all circuitry to be hidden inside the shade. All other competitors rely on desktop controller boxes for their dimming units... another Micro-Lite® advantage!

Our exclusive heat management system ensures supreme light output, for many years to come. The special thermal transfer system quickly and efficiently cools the LED array, for the longest life span in the industry. We are the only manufacturer to invest such extensive time and money into the development of the world's best LED ring illuminator.

- Custom **ESD Safe** polymer eliminates any static build up
- 2.35" (60mm) mounting ring diameter - optional 66mm mounting now available
- 9 LED surface mount array with exclusive thermal management system
- 6000K Color Temperature Standard
- **New optional 3500K Color Temperature** (LV3500 and LV3500-B)
- **Ultraviolet (395nm) model now available** (UV2000 and UV2000-B)
- Output greater than a 150 watt fiber optic
- Exclusive larger illuminated area - no small "hot spot" ever due to changes in working distance!
- Flicker free and dimmable from 100 – 5%
- No bulky desktop controller box
- 100-240v (50/60hz) auto switchable power supply with worldwide approvals
- Optional adapters available for most microscopes
- 5 Year/50,000 Hour Pro-Rated Warranty



Smart Phone Enabled



All models shown are
Made in the U.S.A.

Microscope Illumination



All models shown are Made in the U.S.A.

Micro-Lite® FL1000 illuminators provide the highest quality “state of the art”, advanced technology lighting in the market today. Advanced electronic circuitry allow our “patented” technology to dim these fluorescent lights like never before. Our standard 2 step dimmable unit combines hi-frequency, flicker free illumination, **ESD safety**, superior lamp technology and soft start technology to provide one of the longest lasting microscope light and bulb combinations in the world market. Dims from 100% down to approx. 60%. Normal bulb life 7500 hours.

Our fully variable Micro-Lite® **FV1000**, provides all of the same superior qualities of the FL1000, but it dims from 100% to approx. 5%. This allows you to control glare, take pictures



FL1000
Micro-Lite® Fluorescent Illuminator



Smart Phone Enabled

better or just simply blend better light on your individual application. Both units are available with our standard 6100°K bulb (FL150), which is superior for machine vision, or our ultraviolet bulb (FL200) for special application lighting such as conformal coating and plating voids. Also, our new (FL320) fiberoptic type bulb mimics the 3200°K put out by fiberoptic lights.

Choose between the hi-low version (FL1000) or our new fully variable (FV1000). Both include our easy in, easy out bulb (exclusive Micro-Lite® base.) Takes but a few seconds to remove and replace! No exposed wires for extra safety. 230 volt available. **Proudly Made in the USA.**

Replacement Bulbs



Smart Phone Enabled



FL3000-A
36" Ultra-Thin Steel Annular Light Guide



FL3000-D
18" Self-Supporting Flexible Dual Arms

Micro-Lite® 150W Halogen Illumination

- Made in the USA
- ESD safe
- Lightweight steel construction
- Internal IR filter standard for ‘cool to the touch’ performance and no more burned up fibers!
- Specialized dimming switch allows for ‘soft’ voltage ramp in milliseconds, which extends the life of the bulb
- Choice of 18” Dual Gooseneck or 36” Ultra-thin steel Annular light guides
- Adjustable Focusing Lenses included standard on Dual Gooseneck models
- Includes 150w EKE Bulb
- Optional nosepieces available to fit light guides from .198”-.998” diameter
- Ceramic internal bulb holder with easy-out lever for fast and safe bulb changes
- Adapters available for most microscopes



61900-B

ProBoom® Elite

ProBoom® Elite is the
ONLY choice for today's
broadcast professional.
Experience for yourself the
O.C. White Advantage!

ON
AIR



61900-3BG
3 Arm Round Table Model
(Shown in Black & Gold)

Distributed By:

www.ocwhite.com
413-289-1751