



SPECIFICATION SHEET

SPECIFICATION SHEET NO.	R0130- CA55D010M477TA	
DATE	Jan. 30, 2024	
REVISION	A0	Updated With Most Recent Data - Official First Release
DESCRIPTION AND MAIN PARAMETRICS	<p>SMD Conductive Polymer Tantalum Capacitors Industrial Grade, CA55 Series, EIA code 7343-28 (2917), Case D, L7.30*W4.30*H2.80mm</p> <p>Rated Voltage 10 Vdc, Capacitance 470μF, Tolerance ±20%</p> <p>ESR 150 mΩ Max. Operating Temp. Range -55° C ~+125° C</p> <p>Package in Tape/Reel</p> <p>REACH/RoHS/RoHS III compliant</p>	
CUSTOMER		
CUSTOMER PART NO.		
CROSS REF. PART NO.	T520/T525/T530/T55/TCJ/TCM/TCN	
ORIGINAL MFG/PART NO.	Xiang Jiang/ CA55-D010M477TE150	
PART CODE	CA55D010M477TA	

VENDOR APPROVE		
Issued/Checked/Approved		
		
DATE: Jan. 30, 2024		

CUSTOMER APPROVE	
DATE:	

SMD CONDUCTIVE POLYMER TANT. CAP. CA55 SERIES CASE D

MAIN FEATURE

- Tantalum Anode Electrolytic Capacitor With Gelled Conductive Polymer As Electrolyte
- Easy Resin Molded Packing SMD Polarity
- J-type Pin Structure
- Low ESR And ESL With Good High-frequency Capacity Retention
- Failure Mode Of Non Combustion And Non Explosion.
- Equipped With Strong Surge Resistance, It Can Reduce The Rating By 10-20% In Low Circuit Impedance Switching Power Supply Circuits To.
- Moisture Sensitivity Level (MSL) III
- REACH/RoHS/RoHS III compliant
- Wide Operating Temperature Range -55 ~ +125°C
- Cross Most Competitors Parts in Market



APPLICATION

- DC/DC Converters, Audio Circuits, Power Inputs, Portable Electronic Products, Telecommunications Consumer Electronics, High-voltage Applications, Highly Integrated Microcircuit Modules, Microprocessor Decoupling And High Ripple Current Applications.

ELECTRICAL CHARACTERISTICS

- See Page 10~ Page 11 For Different Part Code

HOW TO ORDER

- Please follow up Part Code Guide and indicate part code when you order or RFQ For Custom Specification .

SMD CONDUCTIVE POLYMER TANT. CAP. CA55 SERIES CASE D

PART CODE GUIDE

RFQ
Request For Quotation

CODE	NAME	KEY SPECIFICATION OPTION
CA55	Product Series Code	SMD Conductive Polymer Tantalum Capacitors Industrial Grade
D	Case Size Code For Dimension	A: 3216-16 (1206), L3.2*W1.6*H1.6mm; B: 3528-19 (1210), L3.5*W2.8*H1.9mm C: 6032-25 (2312), L6.0*W3.2*H2.5mm; D: 7343-28 (2917), L7.3*W4.3*H2.8mm E: 7343-41 (2917), L7.3*W4.3*H4.1mm; F: 7361-19 (2924), L7.3*W6.1*H1.9mm H: 7343-21 (2917), L7.3*W4.3*H2.1mm; H1: 7343-15 (2917), L7.3*W4.3*H1.5mm L: 7343-19 (2917), L7.3*W4.3*H1.9mm; V: 7361-36 (2924), L7.3*W6.1*H3.6mm W: 7361-41 (2924), L7.3*W6.1*H4.1mm; Y: 7343-40 (2917), L7.3*W4.3*H4.0mm
010	Rated voltage Code	004: 4V; 6R3: 6.3V; 010: 10V; 016: 16V; 020: 20V; 025: 25V; 035: 35V; 050: 50V 063: 60V
M	Capacitance Tolerance code	K: ±10%; M: ±20%
477	Capacitance Code	1st two digits represent Significant figures, 3rd Digit specifies number of Zeros 474: 0.47µF; 684:0.68µF; 105: 1.0µF; 155: 1.5µF; 225: 2.2µF; 335: 3.3µF; 475: 4.7µF; 685: 6.8µF; 106: 10µF; 156: 15µF; 226: 22µF; 336: 33µF; 476: 47µF; 686: 68µF; 107: 100µF; 157: 150µF; 227: 220µF; 337: 330µF; 477: 470µF; 108: 1000µF; 158: 1500µF; 228: 2200µF
TA	Internal Control Code	Letter A~Z Or Digits (1-9)
()	Custom Specification Code	Letter A~Z Or Digits (1-9); Blank: N/A

SMD CONDUCTIVE POLYMER TANT. CAP. CA55 SERIES CASE D

DIMENSION (Unit: mm)

Image for reference

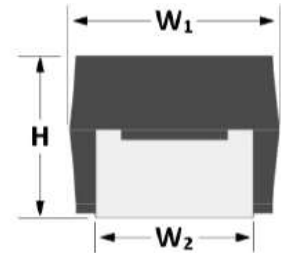
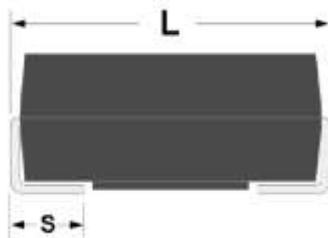

Case Size Code	EIA Code	EIA Metric	L	W ₁	H	S	W ₂
A	1206	3216-16	3.20±0.20	1.60±0.20	1.60±0.30	0.70±0.20	1.20±0.20
B	1210	3528-19	3.50±0.20	2.80±0.20	1.90±0.30	0.70±0.20	2.20±0.20
C	2312	6032-25	6.00±0.30	3.20±0.30	2.50±0.30	1.30±0.30	2.20±0.20
D	2917	7343-28	7.30±0.30	4.30±0.30	2.80±0.30	1.30±0.30	2.40±0.20
E	2917	7343-41	7.30±0.30	4.30±0.30	4.10±0.30	1.30±0.30	2.40±0.20
F	2924	7361-19	7.30±0.30	6.10±0.30	1.90±0.30	1.40±0.30	3.00±0.20
H	2917	7343-21	7.30±0.30	4.30±0.30	2.10±0.30	1.30±0.30	2.40±0.20
H1	2917	7343-15	7.30±0.30	4.30±0.30	1.50 (0~0.05)	1.30±0.30	2.40±0.20
L	2917	7343-19	7.30±0.30	4.30±0.30	1.90±0.30	1.30±0.30	2.40±0.20
V	2924	7361-36	7.30±0.30	6.10±0.30	3.60±0.30	1.40±0.30	3.00±0.20
W	2924	7361-41	7.30±0.30	6.10±0.30	4.10±0.30	1.40±0.30	3.00±0.20
Y	2917	7343-40	7.30±0.30	4.30±0.30	4.00±0.30	1.30±0.30	2.40±0.20

SMD CONDUCTIVE POLYMER TANT. CAP. CA55 SERIES CASE D
LAND DIMENSIONS

Density Level A: For low-density product applications. Recommended for wave solder applications and provides a wider process window for reflow solder processes.

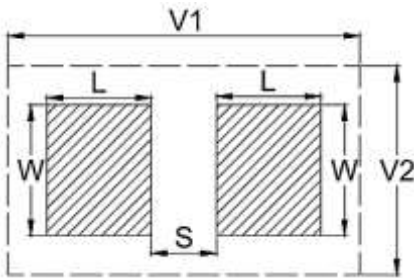

Note:

- Height of these chips may create problems in wave soldering.
- Land pattern geometry is too small for silkscreen outline.

Case Code	EIA Metric	Dimension (mm)				
		W	L	S	V1	V2
A	3216-16	1.35	2.20	0.62	6.02	2.80
B	3528-19	2.35	2.21	0.92	6.32	4.00
C	6032-25	2.35	2.77	2.37	8.92	4.50
D	7343-28	2.55	2.77	3.67	10.22	5.60
E	7343-41	2.55	2.77	3.67	10.22	5.60
F	7361-19	3.25	2.77	3.67	10.22	7.30
H	7343-21	2.55	2.77	3.67	10.22	5.60
H1	7343-15	2.55	2.77	3.67	10.22	5.60
L	7343-19	2.55	2.77	3.67	10.22	5.60
V	7361-36	3.25	2.77	3.67	10.22	7.30
W	7361-41	3.25	2.77	3.67	10.22	7.30
Y	7343-40	2.55	2.77	3.67	10.22	5.60

SMD CONDUCTIVE POLYMER TANT. CAP. CA55 SERIES CASE D

LAND DIMENSIONS

Density Level B: For products with a moderate level of component density. Provides Recommended Profile

Conditions for reflow solder processes.

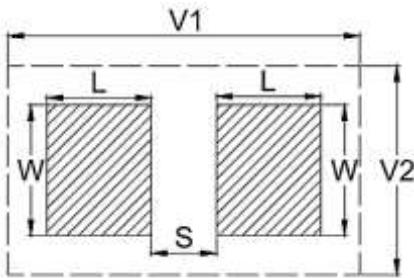

Note:

- Height of these chips may create problems in wave soldering.
- Land pattern geometry is too small for silkscreen outline.

Case Code	EIA Metric	Dimension (mm)				
		W	L	S	V1	V2
A	3216-16	1.23	1.80	0.82	4.92	2.30
B	3528-19	2.23	1.80	1.12	5.22	3.50
C	6032-25	2.23	2.37	2.57	7.82	4.00
D	7343-28	2.43	2.37	3.87	9.12	5.10
E	7343-41	2.43	2.37	3.87	9.12	5.10
F	7361-19	3.13	2.37	3.87	9.12	6.80
H	7343-21	2.43	2.37	3.87	9.12	5.10
H1	7343-15	2.43	2.37	3.87	9.12	5.10
L	7343-19	2.43	2.37	3.87	9.12	5.10
V	7361-36	3.13	2.37	3.87	9.12	6.80
W	7361-41	3.13	2.37	3.87	9.12	6.80
Y	7343-40	2.43	2.37	3.87	9.12	5.10

SMD CONDUCTIVE POLYMER TANT. CAP. CA55 SERIES CASE D

LAND DIMENSIONS

Density Level C: For high component density product applications. Before adapting the Min. land pattern variations, the user should perform qualification testing based on the conditions outlined in IPC - 7351).

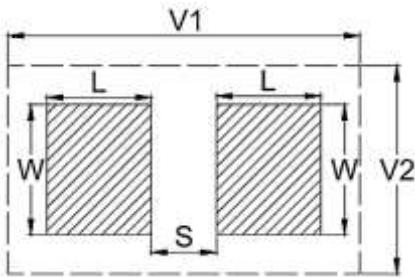

Note:

- Height of these chips may create problems in wave soldering.
- Land pattern geometry is too small for silkscreen outline.

Case Code	EIA Metric	Dimension (mm)				
		W	L	S	V1	V2
A	3216-16	1.13	1.42	0.98	4.06	2.04
B	3528-19	2.13	1.42	1.28	4.36	3.24
C	6032-25	2.13	1.99	2.73	6.96	3.74
D	7343-28	2.33	1.99	4.03	8.26	4.84
E	7343-41	2.33	1.99	4.03	8.26	4.84
F	7361-19	3.03	1.99	4.03	8.26	6.54
H	7343-21	2.33	1.99	4.03	8.26	4.84
H1	7343-15	2.33	1.99	4.03	8.26	4.84
L	7343-19	2.33	1.99	4.03	8.26	4.84
V	7361-36	3.03	1.99	4.03	8.26	6.54
W	7361-41	3.03	1.99	4.03	8.26	6.54
Y	7343-40	2.33	1.99	4.03	8.26	4.84

SMD CONDUCTIVE POLYMER TANT. CAP. CA55 SERIES CASE D

MARKING

Rate Voltage Code: A=10V

Capacitance code: 470μF

Polarity: Anode (+)

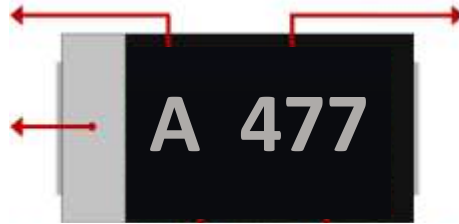

Voltage Code	F	G	J	A	C	D	E	V	T
Rate Voltage (V)	2.5	4.0	6.3	10	16	20	25	35	50

MAXIMUM OPERATING AND SURGE VOLTAGES VS. TEMPERATURE

Rate Voltage (V R)	≤ 85°C	2.5	4.0	6.3	10	16	20	25	35	50
Category Voltage (V c)	≤ 125°C	1.7	2.7	4	6.3	10	15	17	23	33
Surge Voltage (V s)	≤ 85°C	3.3	5.2	8	13	20	26	32	46	65
Surge Voltage (V s)	≤ 125°C	2.2	3.4	5	8	13	16	20	28	40

SMD CONDUCTIVE POLYMER TANT. CAP. CA55 SERIES CASE D

BASIC INFORMATION

ITEM	CHARACTERISTIC
Dielectric	Ta2O5
Electrolyte	PEDOT
Package Method	Epoxy Resin Molding (Semi-Sealing)
Case Color	Black (standard) or Yellow
MSL	III
Termination Finish	Standard solder-coated, Gold-plated option

STANDARD CHARACTERISTICS

PART CODE	CA55D010M477TA
Case Size Code	D
Case Dimension	L7.3*W4.3*H2.8mm
EIA Code	7343-28 (2917)
Capacitance Tolerance	±20%
Rate Temperature Range	85 °C
Category Voltage	7V
Category Temperature Range	125 °C
Operating Temperature Range	-55~ + 125 °C

SMD CONDUCTIVE POLYMER TANT. CAP. CA55 SERIES CASE D
ELECTRONICAL CHARACTERISTICS FOR MAIN PARTS

Part Code	Rate Voltage ≤ 85°C	Cap. @25°C 100Hz	ESR @25°C 100 KHz	Max. Dissipation Factor (DF) @25°C 100Hz	Max. Leakage Current @+25°C 5 min.	Max. Ripple Current		
						@ 25°C 100 KHz	@ 85 °C 100 KHz	@ 125°C 100 KHz
	V	µF	mΩ	%	µA	mA		
CA55B6R3M107TA	6.3	100	400	10	100	559	503	224
CA55B6R3M157TA	6.3	150	400	10	95	559	503	224
CA55C6R3M227TA	6.3	220	200	10	139	935	842	374
CA55B6R3M227TA	6.3	220	400	10	139	559	503	224
CA55C6R3M337TA	6.3	330	150	10	208	1080	972	432
CA55D6R3M477TA	6.3	470	100	10	296	1500	1350	600
CA55B010M476TA	10	47	400	10	47	559	503	224
CA55B010M107TA	10	100	400	10	100	559	503	224
CA55D010M107TA	10	100	200	10	100	1061	955	424
CA55D010M227TA	10	220	150	10	220	1225	1102	490
CA55C010M227TA	10	220	200	10	220	935	842	374
CA55C010M337TA	10	330	150	10	330	1080	972	432
CA55D010M477TA	10	470	150	10	470	1225	1102	490
CA55E010M477TA	10	470	150	10	470	1291	1162	516
CA55C010M157TA	10	150	250	10	150	837	753	335
CA55B016M226TA	16	22	400	10	35	559	503	224
CA55B016M336TA	16	33	400	10	53	559	503	224
CA55C016M107TA	16	100	250	10	160	837	753	335
CA55D016M107TA	16	100	200	10	160	1061	955	424
CA55D016M157TA	16	150	200	10	240	1061	955	424

SMD CONDUCTIVE POLYMER TANT. CAP. CA55 SERIES CASE D
ELECTRONICAL CHARACTERISTICS FOR MAIN PARTS

Part Code	Rate Voltage ≤ 85°C	Cap. @25°C 100Hz	ESR @25°C 100 KHz	Max. Dissipation Factor (DF) @25°C 100Hz	Max. Leakage Current @+25°C 5 min.	Max. Ripple Current		
						@ 25°C 100 KHz	@ 85 °C 100 KHz	@ 125°C 100 KHz
	V	μF	mΩ	%	μA	mA		
CA55D016M227TA	16	220	100	10	352	1500	1350	600
CA55E016M337TA	16	330	100	10	528	1581	1423	632
CA55D020M107TA	20	100	200	10	200	1061	955	424
CA55H020M107TB	20	100	150	10	200	1111	999	444
CA55B025M156TA	25	15	600	10	37.5	456	411	183
CA55C025M226TA	25	22	250	10	55	837	753	335
CA55D025M476TA	25	47	200	10	117.5	1061	955	424
CA55D025M686TA	25	68	150	10	170	1225	1102	490
CA55E025M107TA	25	100	150	10	250	1291	1162	516
CA55D025M107TA	25	100	200	10	250	1061	955	424
CA55F025M227TA	25	220	100	10	550	1414	1273	566
CA55D035M226TA	35	22	200	10	77	1061	955	424
CA55C035M106TA	35	10	300	10	35	764	687	306
CA55D035M336TA	35	33	200	10	115.5	1061	955	424
CA55D035M476TA	35	47	150	10	164.5	1225	1102	490
CA55E035M476TA	35	47	100	10	164.5	1581	1423	632
CA55C050M335TA	50	3.3	400	10	16.5	661	595	265
CA55C050M225TA	50	2.2	400	10	11	661	595	265
CA55E050M476TA	50	47	100	10	235	1581	1423	632

SMD CONDUCTIVE POLYMER TANT. CAP. CA55 SERIES CASE D

RECOMMENDED PROFILE CONDITIONS –Only For reference

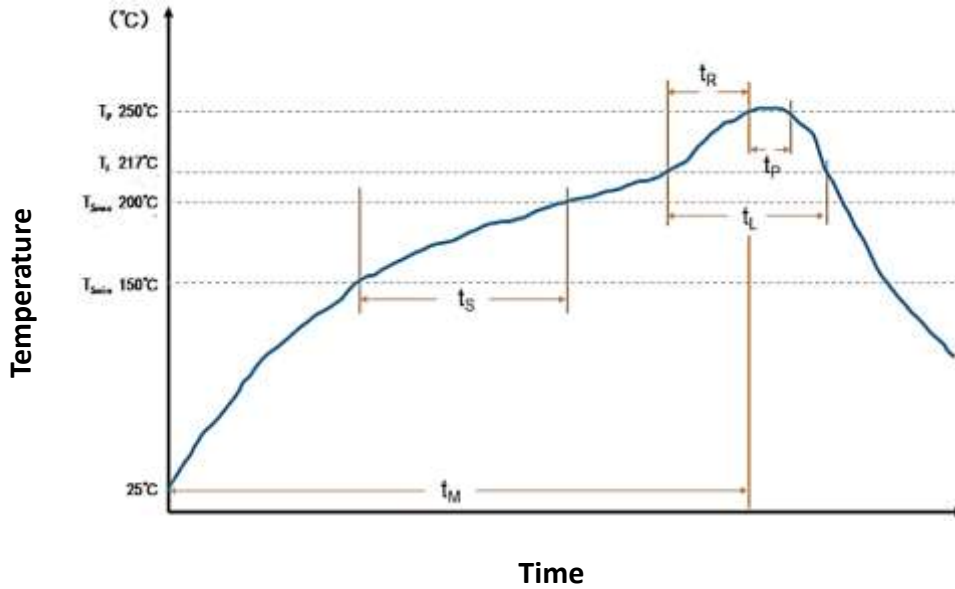

Characteristics	Unit	Symbol	SnPb Assembly	Pb-Free Assemble
Preheat Temperature Min.	°C	T smin	100	150
Preheat Temperature Max.	°C	T smax	150	200
Preheat time	Second	T s	60~120	60~120
Ramp-up Rate	°C/Second	T L to T p	≤ 3	≤ 3
Liquidous Temperature	°C	T L	183	217
Time Above Liquidous	Second	t L	60~150	60~150
Peak Temperature	°C	T p	220 or 235	245 or 250
Time within 5°C Max. Peak Temperature	Second	t p	≤ 10	≤ 3
Ramp-down Rate	°C/Second	T p to T L	≤ 6	≤ 6
Time 25°C to Peak Temperature	minute		≤ 6	≤ 8

SMD CONDUCTIVE POLYMER TANT. CAP. CA55 SERIES CASE D

RECOMMENDED VOLTAGE DERATING GUIDELINES – Only For reference

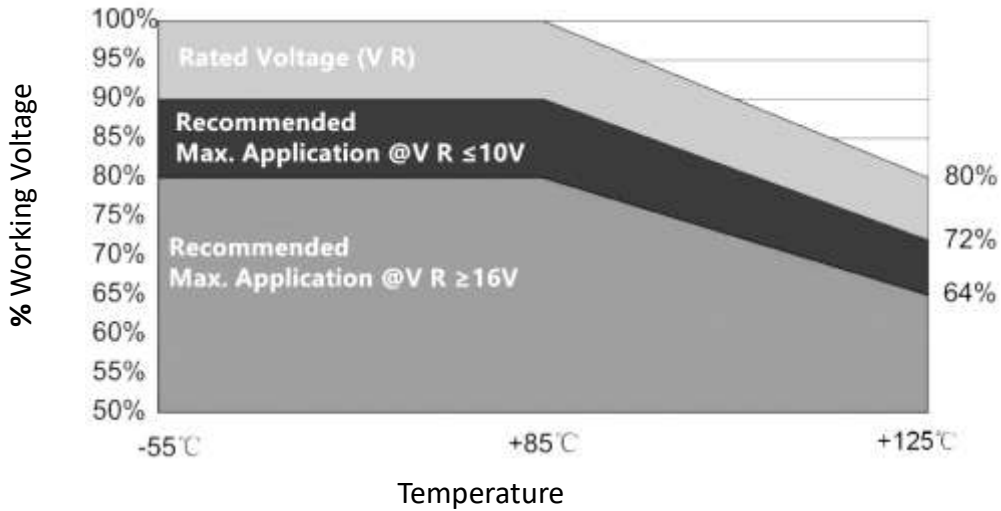

Series Code	Electrolyte	Safe Load Voltage Max.	-55°C~+85°C	+85°C~+125°C	
CA55	PEDOT	Energy Storage and Coupling Circuit	V _R	$V_R - (V_R - V_C) * (T - 85) / 40$	
		Filter Circuit	V _R ≤ 10V	90% V _R	$90% * [V_R - (V_R - V_C) * (T - 85) / 40]$
			V _R > 10V	80% V _R	$80% * [V_R - (V_R - V_C) * (T - 85) / 40]$

Note: V_R: Rated voltage (V) at ≤ 85°C; V_C: Derating voltage at 125°C; T: Ambient temperature (°C)

SMD CONDUCTIVE POLYMER TANT. CAP. CA55 SERIES CASE D

TAPE DIMENSION (Unit: mm, Tolerance ± 0.2 mm over 10 sprocket hole spaces)

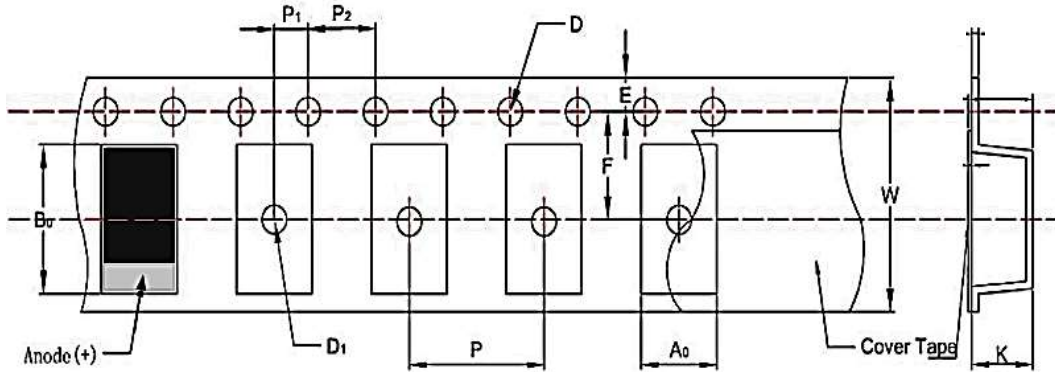

Case Size Code	Dimension										
	A0	B0	K	W	E	F	P	P1	P2	D	D1
	± 0.1	± 0.1	± 0.1	± 0.3	± 0.1	± 0.05	± 0.1	± 0.05	± 0.1	± 0.2	± 0.25
A	1.88	3.53	1.85	8	1.75	3.5	4	4	2	1.55	1.0
B	3.07	3.8	2.22	8	1.75	3.5	4	4	2	1.55	1.1
C	3.6	6.4	2.85	12	1.75	5.5	4	8	2	1.55	1.6
D	4.6	7.6	3.1	12	1.75	5.5	4	8	2	1.55	1.55
E	4.6	7.6	4.4	12	1.75	5.5	4	8	2	1.55	1.55
F	6.5	7.8	2.2	12	1.75	5.5	4	8	2	1.55	1.5
H	4.6	7.6	2.16	12	1.75	5.5	4	8	2	1.55	1.55
H1	4.6	7.6	2.16	12	1.75	5.5	4	8	2	1.55	1.55
L	4.6	7.6	2.16	12	1.75	5.5	4	8	2	1.55	1.55
V	6.4	7.6	4.4	12	1.75	5.5	4	8	2	1.55	1.55
W	6.4	7.6	4.4	12	1.75	5.5	4	8	2	1.55	1.55
Y	4.6	7.6	3.1	12	1.75	5.5	4	8	2	1.55	1.55

SMD CONDUCTIVE POLYMER TANT. CAP. CA55 SERIES CASE D

REEL DIMENSION (Unit: mm)

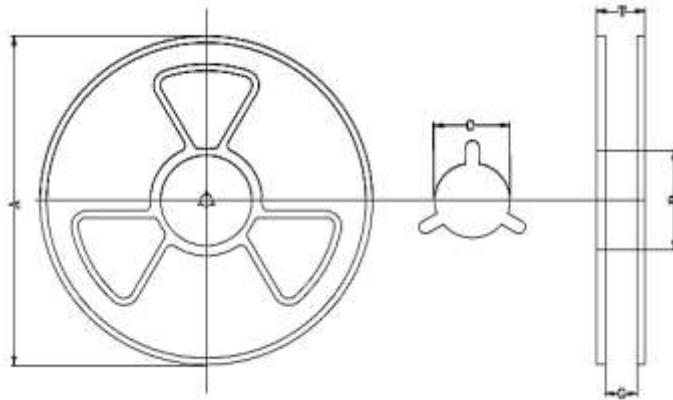

Reel Size	Tape Wide	Dimension				
		A	B	C	W	T
7" (180 mm)	8	178±2.0	50 Min.	13±0.5	8.4+1.5/-0	1.5±0.5
7" (180 mm)	12	178±2.0	50 Min.	13±0.5	12.4+1.5/0	1.5±0.5
7" (180 mm)	16	178±2.0	50 Min.	13±0.5	16.4+1.5/-1	1.5±0.5

QTY PER REEL (Unit: pcs)

Case Size Code	A	B	C	D	E	F	H	H1	L	V	W	Y
Qty.	2000	2000	500	500	500	800	1000	1000	1000	400	400	500

SMD CONDUCTIVE POLYMER TANT. CAP. CA55 SERIES CASE D

APPLICATION NTOE

Storage Condition

1. Environmental temperature: 10°C ~ +30°C
2. Relative humidity no more than 60%
3. Storing period: No more than one and half year since the date of stocking.

APPLICATION GUIDE

Ripple Current and Voltage

If the ripple current is applied to the capacitor, the Joule heat (power dissipated) will be generated in the capacitor, so it will affect the reliability of the capacitor.

(1) Power Dissipated

The actual power dissipated can be calculated using the following formula: $P=I^2 \times ESR$Formula 1

P: Power dissipated (W); I: Ripple current (A); ESR: Equivalent series resistance (Ω)

(2) Ripple Current

Using the maximum power dissipation the ripple current can be calculated using the following formula:

$$I = \sqrt{\frac{P}{ESR}} \times K \times F \text{.....Formula 2}$$

K: Temperature derating factor..... Table 1; F: Frequency derating factor..... Table 2

ESR: Refer to the ratings of each specific product

Table 1: Temperature Drop Factor K

Temperature	Temperature Derating Factor K
25 °C	1
85 °C	0.9
125 °C	0.4

Table 2: Frequency Derating Factor F

Frequency (KHz)	10	100	500	1000
MnO2	0.80	1.0	1.15	1.20
Polymer	0.75	1.0	1.10	1.30

Using formula 3 to calculate corrugated voltage E: $E=Z \times I$ Formula 3

E: Ripple voltage; Z: Specific frequency impedance

SMD CONDUCTIVE POLYMER TANT. CAP. CA55 SERIES CASE D

Ripple Voltage

The ripple voltage applied to the capacitor is limited by three criteria.

- a) The power dissipation in the ESR of capacitor must not exceed Max.Dissipation Factor (DF) @25°C 100Hz.
- b) The positive peak AC voltage plus the DC bias voltage must not exceed the DC voltage rating of the capacitor.
- c) The negative peak AC voltage, in combination with the bias voltage, if any , must not exceed the permissible reverse voltage ratings presented .

Reverse Voltage

Solid tantalum capacitors are polarized devices , and applied reverse voltage can not be allowed . If the reverse voltage is unavoidable, a small degree of transient reverse voltage is permissible for short periods as follow.

25°C..... 10% of Max. rated voltage or 1V whichever is smaller

85°C..... 5% of Max. rated voltage or 0.5V whichever is smaller

125°C.....1% of Max. rated voltage or 0.1V whichever is smaller

Even under these restrictions, capacitors can not be used continuously in reverse voltage mode.

Working Voltage

(1) For general applications, using 50% of rated voltage of capacitors or less.

(2) When used at the power circuit, low impedance circuit , coupling circuit or witching circuit which has leakage current problems, please design the circuit with voltage under 30% of the working voltage (max 50%) to avoid the adverse effect of the surge current.

(3) Derating voltage when temperature above 85°C.

When the chip tantalum capacitor is used at 85°C or more temperatures, the reduced voltage (V_T) is calculated from the following expression, however, note that the ambient temperature is not more than 125°C.

$$V_T = V_0 (V_R - V_C)(T - 85) / 40$$

V_R : Rated voltage (V); V_C : Derating voltage at 125°C; T : Ambient temperature (°C)

SMD CONDUCTIVE POLYMER TANT. CAP. CA55 SERIES CASE D

Protective Resistance

In a circuit (switching circuit, charge / discharge circuit, etc.) that has an instantaneous current, series resistance is at least $3\Omega/V$, this can improve the reliability of tantalum capacitors. If the capacitor is in a low impedance circuit, the voltage applied to the capacitor should be half or one third of the rated voltage.

Redundancy

MnO₂ tantalum capacitors will heat, and may cause fire and burn in the short circuit. This is determined by the situation, time and other factors. When the circuit is designed, it is possible to provide the best possible space to keep the tantalum capacitor reliability.

Test Condition

Ambient Temperature 25°C; Relative Humidity 60 to 70%; Air Pressure 800 to 1060mbar. Test and experiment, in order to make the test results not problems, it is necessary to will test the product after fully discharge.

This product is a polar components, testing or when using it is strictly prohibited to will is negative pick back, in order to avoid performance failure

Soldering

The SMD tantalum capacitor can be used for reflow soldering, which is not suitable for wave soldering and manual welding. The reflow temperature are $\leq 250^{\circ}\text{C}$, ≤ 3 seconds. If you must use manual welding, should use the melted solder to contact lead, and the electric soldering iron power should be less than or equal to 25W, temperature should be less than 300°C , welding time should be less than 3 seconds, can not use electric iron contact the product lead directly, and in particular, can not contact the product ontology directly. Recommended profile conditions for convection and IR reflow reflect the profile conditions of the IPC/J-STD-020D standard for moisture sensitivity testing

SMD CONDUCTIVE POLYMER TANT. CAP. CA55 SERIES CASE D

IMPORTANT NOTES AND DISCLAIMER

1. **ROHS COMPLIANCE:** The levels of RoHS restricted materials in this product are below the maximum concentration values (also referred to as the threshold limits) permitted for such substances, or are used in an exempted application, in accordance with EU RoHS Directive (EU) 2015/863 EC (RoHS3). RoHS Test Report for this product can be obtained at Download Center.
2. **REACH COMPLIANCE:** REACH substances of high concern (SVHCs) information is available for this product. Since the European Chemical Agency (ECHA) has published notice of their intent to frequently revise the SVHC listing for the foreseeable future, REACH Test Report for this product can be obtained at Download Center.
3. All Product parametric performance is indicated in the Electrical Characteristics for the listed herein test conditions, unless otherwise noted. Product performance may not be indicated by the Electrical Characteristics if operated under different conditions.
4. NextGen Component, Inc (*NextGen*) reserves the right to make changes to this document and its products and specifications at any time without notice. Customers should obtain and confirm the latest product information and specifications before final design, purchase or use.
5. *NextGen* makes no warranty, representation or guarantee regarding the suitability of its products for any particular purpose, not does *NextGen* assume any liability for application assistance or customer product design.
6. *NextGen* does not warrant or accept any liability with products which are purchased or used for any unintended or unauthorized application. No license is granted by implication or otherwise under any intellectual property rights of NextGen.
7. *NextGen* products are not authorized for use as critical components in life support devices or systems without express written approval by *NextGen*.
8. *NextGen* requires that customers first obtain an RMA (Returned Merchandise Authorization) number prior to returning any products. Returns must be made within 30 days of the date of invoice, be in the original packaging, unused and like-new condition. At the time of quoting or purchasing, a product may say that it is Non-Cancelable/ Non-Returnable (NCNR). These products are not returnable and not refundable.