

UNCONTROLLED DOCUMENT

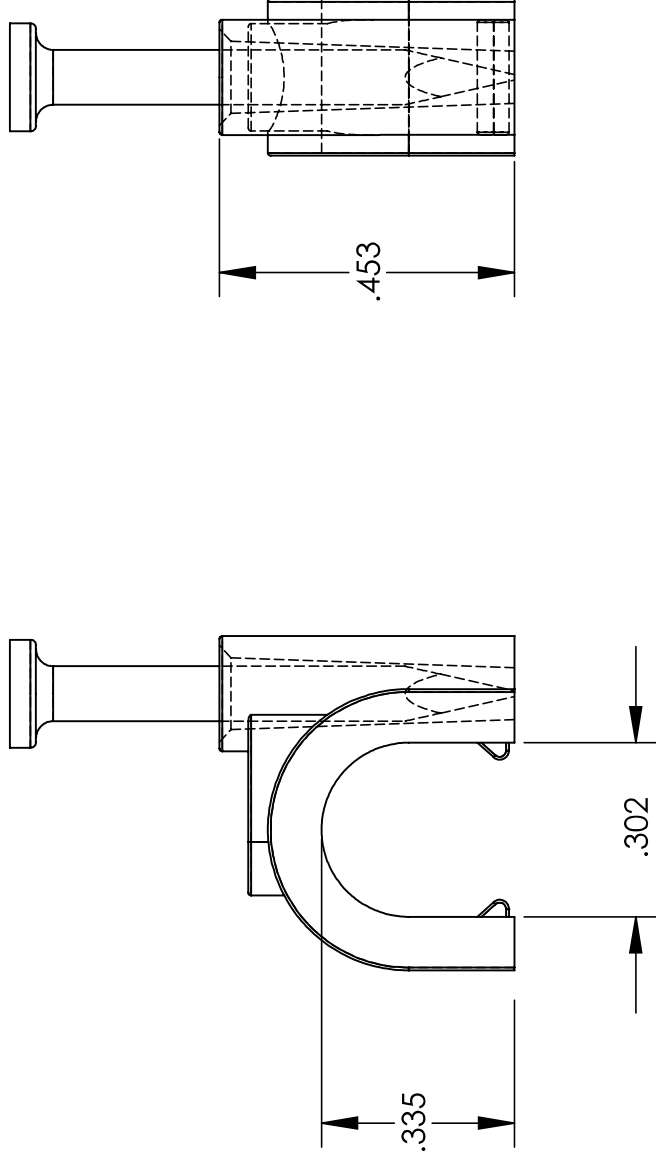

MATERIALS:
CLIPS: HIGH DENSITY POLYETHYLENE; WHITE
NAILS: NICKEL PLATED STEEL
PACKAGING 100 PCS

TOLERANCES UNLESS NOTED

- ±.005 ON DIMENSIONS THRU .625
- ±.008 ON DIMENSIONS .626 THRU 1.000
- ±.010 ON DIMENSIONS 1.001 THRU 1.500
- ±.015 ON DIMENSIONS LARGER THAN 1.500
- ±.015 ON FRACTIONAL DIMENSIONS

**WE RESERVE THE RIGHT
TO DISCONTINUE ITEMS,
CHANGE SPECIFICATIONS
OR DESIGN AT ANY TIME
WITHOUT NOTICE AND
WITHOUT INCURRING
ANY OBLIGATIONS**

PROPERTY OF

MICRO PLASTICS INC.

CATALOG DRAWING
NAIL IN CABLE CLIP (SINGLE, ROUND CABLE)
MICRO P/N 22NCCC0800RW
DWG. # 22NCCC0800RW
FILE SERVER\ENG\WEB

MATERIAL: AS NOTED

DATE

SCALE

3:1

DB