



SPECIFICATION SHEET

SPECIFICATION SHEET NO.	Q1227-SS25B00000SSMB	
DATE	Dec. 27, 2023	
REVISION	A0	Updated With Most Recent Data - Official First Release
DESCRIPTION AND MAIN PARAMETRICS	<p>SMD Schottky Barrier Rectifier, 2 Pads, SMB series, SS25B Type Reverse Voltage 50V Max. Forward Current 2.0A Max. Operating Temp. Range -50° C ~+125° C, Package in Tape/Reel, 3000pcs/Reel Halogen Free (HF), REACH/RoHS/RoHS III compliant, RoHS Annex III lead Exemption (Exempt per RoHS EU 2015/863)</p>	
CUSTOMER		
CUSTOMER PART NO.		
CROSS REF. PART NO.		
ORIGINAL MFG/PART NO.	MDD Diodes/SS25B	
PART CODE	SS25B00000SSMB	

VENDOR APPROVE		
Issued/Checked/Approved		
DATE: Dec. 27, 2023		

CUSTOMER APPROVE	
DATE:	

SMD SCHOTTKY BARRIER RECTIFIER SMB SERIES

MAIN FEATURE

- The Plastic Package Carries Underwriters Laboratory Flammability Classification 94V-0
- Metal Silicon Junction, Majority Carrier Conduction
- Low Power Loss, High Efficiency
- Built-in Strain Relief, Ideal For Automated Placement
- High Temperature Soldering Guaranteed: 260°C/10 Seconds At Terminals
- REACH/RoHS/RoHS III compliant, RoHS Annex III lead Exemption (Exempt per RoHS EU 2015/863)
- Cross Main Competitor Parts In Market



APPLICATION

- For surface mounted applications

RFQ

[Request For Quotation](#)

PART CODE GUIDE

SS25B	00000S	S	MB
1	2	3	4

1. SS25B: SMD Schottky Barrier Rectifier, 2.0A, 50V, 2 Pads, SMB series,
2. 00000S: Special Parameters Code for custom part; Blank: N/A
3. S: Package code, Tape/Reel
4. MB: Internal Control Code Or Special Code, Letter A~Z Or Digits (1-9); Blank: N/A

ELECTRICAL CHARACTERISTICS

- See Page 5 For Different Part Code

HOW TO ORDER

- Please indicate part code and send us your RFQ by E-mail sales@nextgencomponent.com

SMD SCHOTTKY BARRIER RECTIFIER SMB SERIES

DIMENSION - Unit: Inch/mm

Image for reference



Marking: Standard

Case Dimension:

SMB/DO-214AA

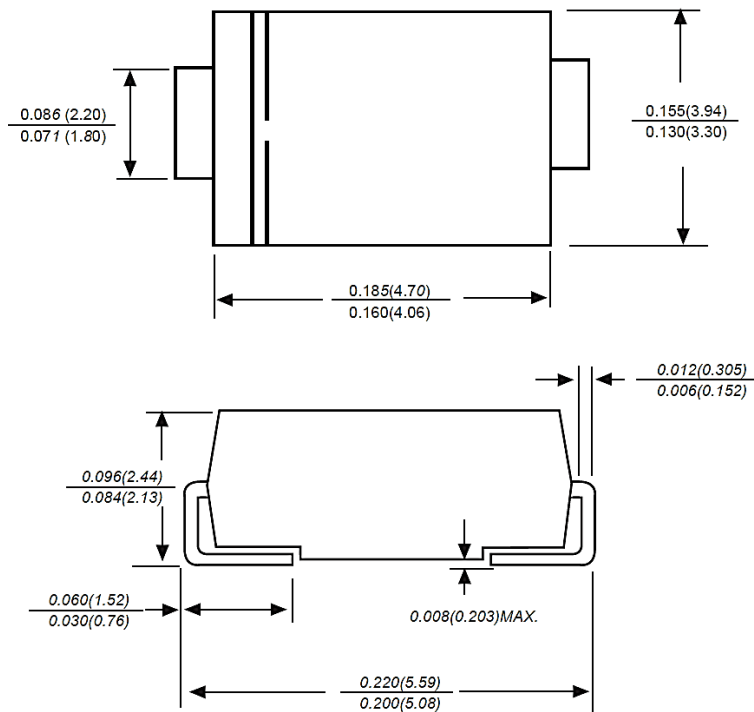

Recommend Pad Layout

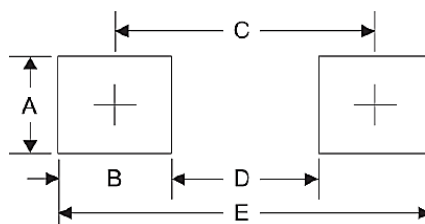

SYMBOL	UNIT (INCH)	UNIT (MM)
A	0.110	2.80
B	0.094	2.40
C	0.181	4.60
D	0.086	2.20
E	0.276	7.00

SMD SCHOTTKY BARRIER RECTIFIER SMB SERIES
MECHANICAL DATA

CASE	TERMINALS	POLARITY	MOUNTING POSITION	MARKING	WEIGHT PER PIECE
JEDEC SMB/DO-214AA molded plastic body	Solderable per MIL-STD-750, Method 2026	Color band denotes cathode end Mounting	ANY	See Marking Code List (Page 5~Page 6)	0.003 ounce 0.093 grams

MAX. RATING & CHARACTERISTICS - Ratings at 25°C Ambient Temperature Unless Otherwise Specified.

PARAMETER	SYMBOLS	VALUE	UNITS
Forward Rectified Current	I (AV)	2.0	A
Typical Thermal Resistance	R θ JA	60	°C/W
Junction Temperature	T _J	-50 ~ +125	°C
Storage Temperature Range	T _{stg}	-50 ~ +150	°C

Notes

1. Measured at 1MHz and applied reverse voltage of 4.0V D.C.
2. P.C.B. mounted with 2.0"x2.0"(5.0x5.0cm) copper pad areas

SMD SCHOTTKY BARRIER RECTIFIER SMB SERIES
MAX. RATING & CHARACTERISTICS

- Ratings at 25°C Ambient Temperature Unless Otherwise Specified.
- Single phase half-wave 60Hz, resistive or inductive load, for capacitive load current derate by 20%.

Part Code	Max. Repetitive Peak Reverse Voltage (VRRM)	Max. RMS Voltage (VRMS)	Max. DC Blocking Voltage (V DC)	Peak forward surge current (see Note 1) (IFSM)	Max. Instantaneous Forward Voltage at 2.0A (VF)	Max. DC Reverse Current @ Rated DC Blocking Voltage (IR)		Typical Junction Cap. (Cj) (See Note 2)
						@ 25°C	@ 100°C	
						mA		
SS22B00000SSMB	20	14	20	55	0.55	0.5	5.0	220
SS23B00000SSMB	30	21	30	55	0.55	0.5	5.0	220
SS24B00000SSMB	40	28	40	55	0.55	0.5	5.0	220
SS25B00000SSMB	50	35	50	55	0.70	0.5	5.0	220
SS26B00000SSMB	60	42	60	55	0.70	0.5	5.0	220
SS28B00000SSMB	80	56	80	45	0.85	0.3	3.0	110
SS210B00000SSMB	100	70	100	45	0.85	0.3	3.0	110
SS2150B0000SSMB	150	105	150	45	0.95	0.3	3.0	110
SS2200B0000SSMB	200	140	200	45	0.95	0.3	3.0	110

Notes

1. 8.3ms single half sine-wave, superimposed on rated load (JEDEC Method)
2. P.C.B. mounted with 2.0"x2.0" (5.0x5.0cm) copper pad areas
3. Measured at 1MHz and applied reverse voltage of 4.0V D.C.

SMD SCHOTTKY BARRIER RECTIFIER SMB SERIES

RATINGS AND CHARACTERISTIC CURVES (For Reference Only) - Ta= 25°C Unless Otherwise Specified

Fig.1 Forward Current Derating Curve

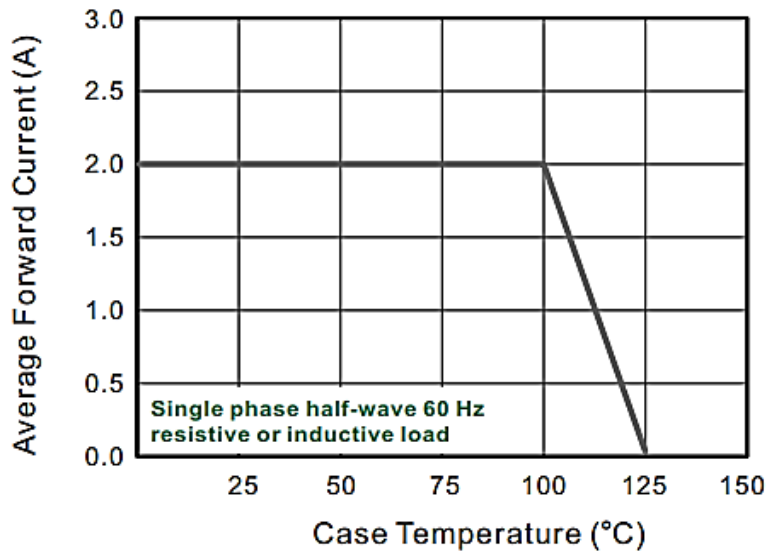
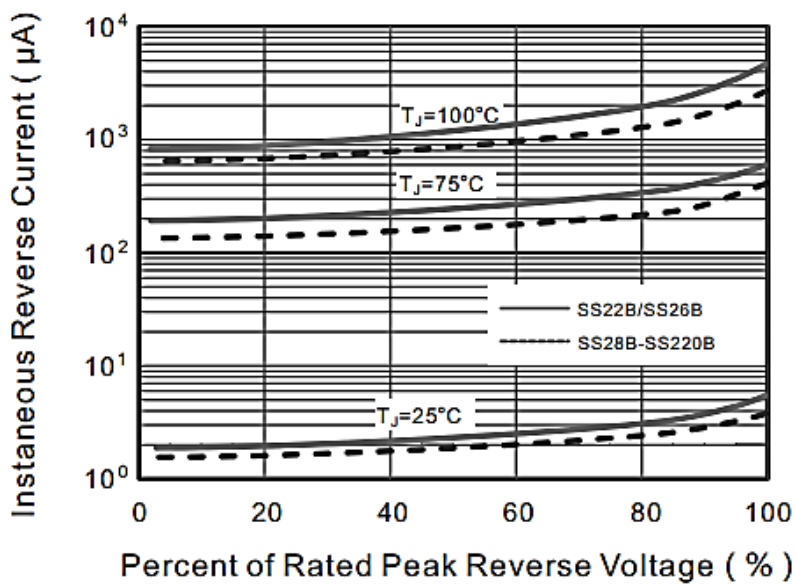

Fig.2 Typical Reverse Characteristics



SMD SCHOTTKY BARRIER RECTIFIER SMB SERIES

RATINGS AND CHARACTERISTIC CURVES (For Reference Only) - $T_a = 25^\circ\text{C}$ Unless Otherwise Specified

Fig.3 Typical Forward Characteristic

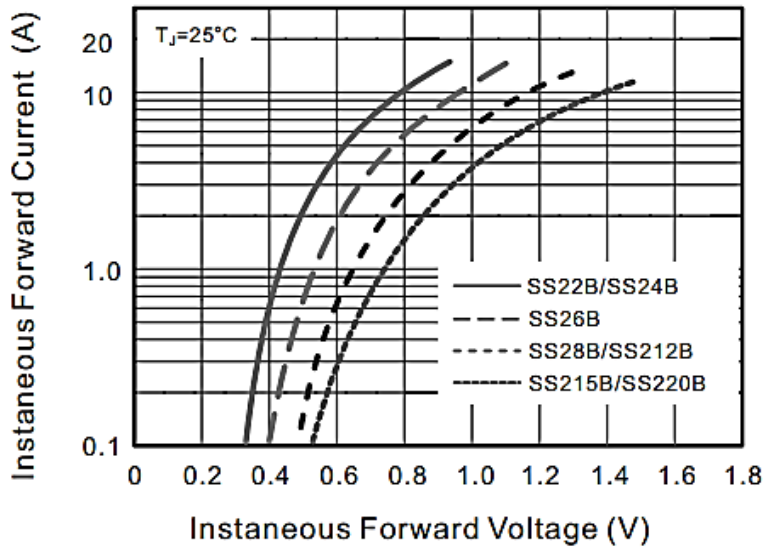
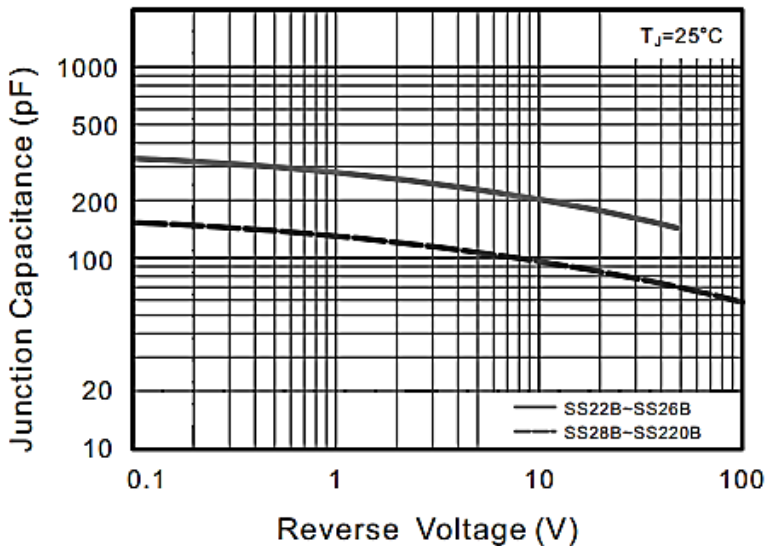

Fig.4 Typical Junction Capacitance



SMD SCHOTTKY BARRIER RECTIFIER SMB SERIES

RATINGS AND CHARACTERISTIC CURVES (For Reference Only) - Ta= 25°C Unless Otherwise Specified

Fig.5 Maximum Non-Repetitive Peak Forward Surge Current

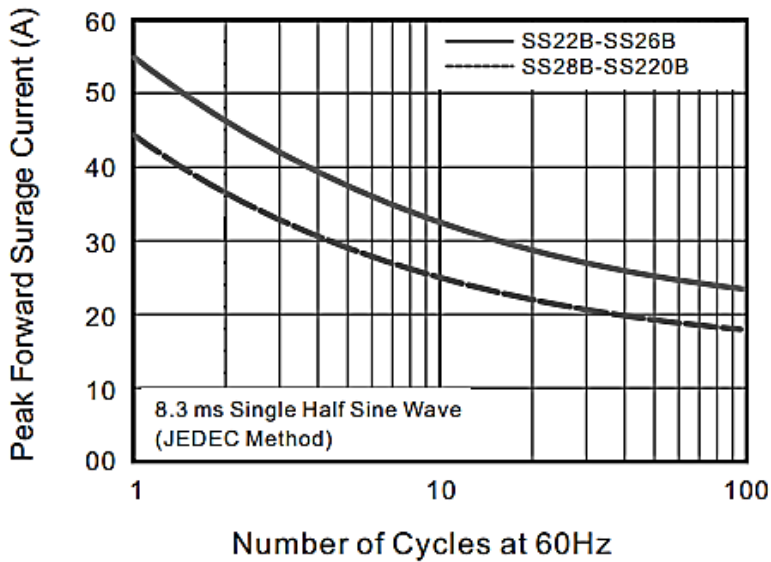
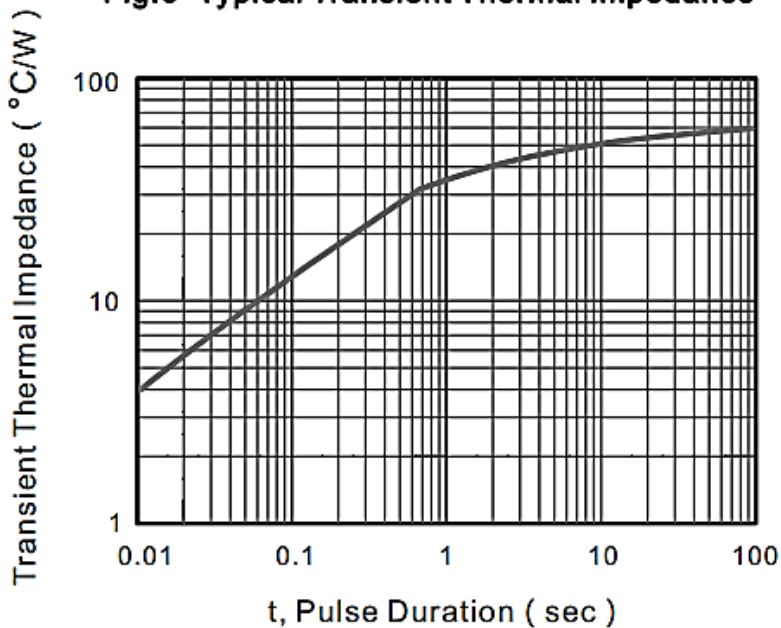

Fig.6- Typical Transient Thermal Impedance



SMD SCHOTTKY BARRIER RECTIFIER SMB SERIES
RELIABILITY

NUMBER	EXPERIMENT ITEMS	EXPERIMENT METHOD AND CONDITIONS	REFERENCE DOCUMENTS
1	Solder Resistance Test	Test 260°C± 5°C for 10 ± 2 sec. Immerse body into solder 1/16" ± 1/32"	MIL-STD-750D METHOD-2031.2
2	Solderability Test	230°C ±5°C for 5 sec.	MIL-STD-750D METHOD-2026.1 0
3	Pull Test	1 kg in axial lead direction for 10 sec.	MIL-STD-750D METHOD-2036.4
4	Bend Test	0.5Kg Weight Applied To Each Lead, Bending Arcs 90 °C ± 5 °C For 3 Times	MIL-STD-750D METHOD-2036.4
5	High Temperature Reverse Bias Test	TA=100°C for 1000 Hours at VR=80% Rated VR	MIL-STD-750D METHOD-1038.4
6	Forward Operation Life Test	TA=25°C Rated Average Rectified Current	MIL-STD-750D METHOD-1027.3
7	Intermittent Operation Life Test	On state: 5 min with rated IRMS Power Off state: 5 min with Cool Forced Air. On and off for 1000 cycles.	MIL-STD-750D METHOD-1036.3
8	Pressure Cooker Test	15 PSIG, TA=121°C, 4 hours	MIL-S-19500 APPENOIXC
9	Temperature Cycling Test	-55°C~+125°C; 30 Minutes For Dwelled Time 5 minutes for transferred time. Total: 10 cycles.	MIL-STD-750D METHOD-1051.7
10	Thermal Shock Test	0°C for 5 minutes., 100°C for 5minutes, Total: 10 cycles	MIL-STD-750D METHOD-1056.7
11	Forward Surge Test	8.3ms Single Sale Sine-wave One Surge.	MIL-STD-750D METHOD-4066.4
12	Humidity Test	TA=65°C, RH=98% for 1000 hours.	MIL-STD-750D METHOD-1021.3
13	High Temperature Storage life Test	150°C for 1000 Hours	MIL-STD-750D METHOD-1031.5

SMD SCHOTTKY BARRIER RECTIFIER SMB SERIES

SUGGESTED REFLOW PROFILE - For Reference Only

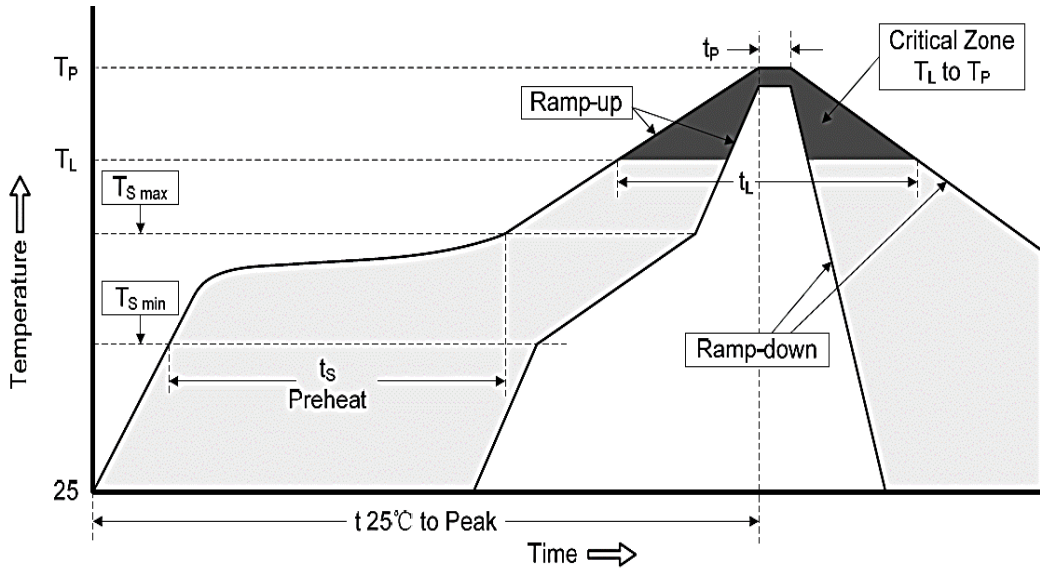

PROFILE FEATURE		PB-FREE ASSEMBLY
Average Ramp-up Rate (Ts Max to Tp)		3°C/second Max
Preheat	Temperature Min (Ts Min.)	150°C
	Temperature Max (Ts Max.)	200°C
	Time (ts Min. to ts Max.)	60 ~ 180 seconds
Time maintained above	Temperature (Tl)	217°C
	Time (tl)	60 ~ 150 seconds
Peak/Classification Temperature (Tp)		260 °C
Time within 5°C of actual Peak Temperature (tp)		20 ~ 40 seconds
Ramp-down rate		6 °C /Second Max.
Time 25 °C to Peak Temperature		8 minutes Max.
Suggest reflow times		3 Times Max.

SMD SCHOTTKY BARRIER RECTIFIER SMB SERIES
TAPE/REEL (Unit: mm)

All Devices are packed in accordance with EIA standard RS-481-A and specifications.

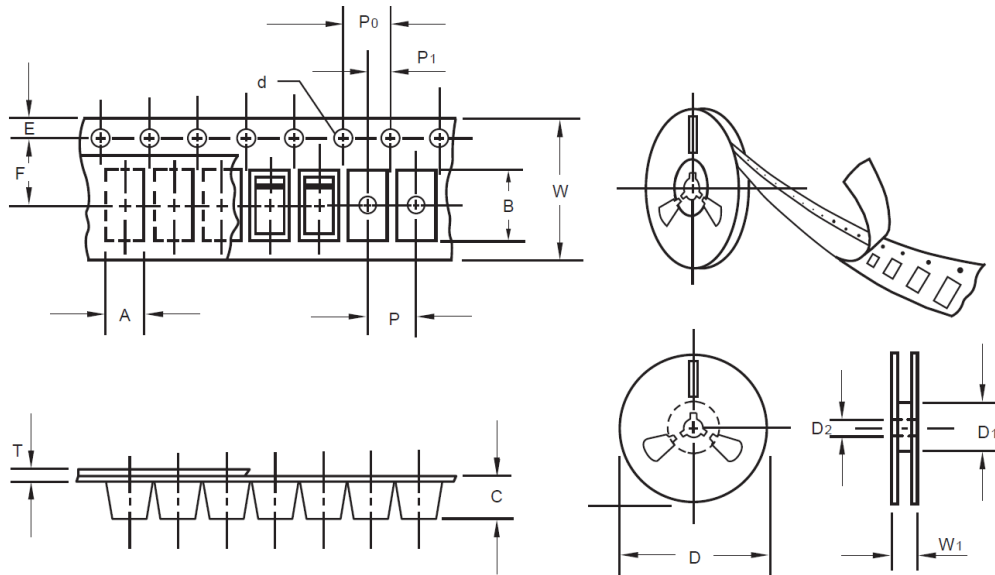

ITEM	SYMBOL	TOLERANCE	SMB/DO-214AA
Carrier width	A	0.1	3.81
Carrier Length	B	0.1	5.41
Carrier Depth	C	0.1	2.42
Sprocket hole	d	0.05	1.50
13"Reel outside diameter	D	2.0	330.00
13"Reel inner diameter	D1	Min.	50.00
7"Reel outside diameter	-	-	-
7"Reel inner diameter	-	-	-
Feed hole diameter	D2	0.5	13.00
Sprocket hole position	E	0.1	1.75
Punch hole position	F	0.1	5.55
Punch hole pitch	P	0.1	8.00
Sprocket hole pitch	P0	0.1	4.00
Embossment center	P1	0.1	2.00
Overall tape thickness	T	0.1	0.30
Tape width	W	0.3	12.00
Reel width	W1	1.0	12.30
Qty. Per Reel (pcs)	3000		

SMD SCHOTTKY BARRIER RECTIFIER SMB SERIES

IMPORTANT NOTES AND DISCLAIMER

1. **ROHS COMPLIANCE:** The levels of RoHS restricted materials in this product are below the maximum concentration values (also referred to as the threshold limits) permitted for such substances, or are used in an exempted application, in accordance with EU RoHS Directive (EU) 2015/863 EC (RoHS3). RoHS Test Report for this product can be obtained at Download Center.
2. **REACH COMPLIANCE:** REACH substances of high concern (SVHCs) information is available for this product. Since the European Chemical Agency (ECHA) has published notice of their intent to frequently revise the SVHC listing for the foreseeable future, REACH Test Report for this product can be obtained at Download Center.
3. All Product parametric performance is indicated in the Electrical Characteristics for the listed herein test conditions, unless otherwise noted. Product performance may not be indicated by the Electrical Characteristics if operated under different conditions.
4. NextGen Component, Inc (*NextGen*) reserves the right to make changes to this document and its products and specifications at any time without notice. Customers should obtain and confirm the latest product information and specifications before final design, purchase or use.
5. *NextGen* makes no warranty, representation or guarantee regarding the suitability of its products for any particular purpose, not does *NextGen* assume any liability for application assistance or customer product design.
6. *NextGen* does not warrant or accept any liability with products which are purchased or used for any unintended or unauthorized application. No license is granted by implication or otherwise under any intellectual property rights of NextGen.
7. *NextGen* products are not authorized for use as critical components in life support devices or systems without express written approval by *NextGen*.
8. *NextGen* requires that customers first obtain an RMA (Returned Merchandise Authorization) number prior to returning any products. Returns must be made within 30 days of the date of invoice, be in the original packaging, unused and like-new condition. At the time of quoting or purchasing, a product may say that it is Non-Cancelable/ Non-Returnable (NCNR). These products are not returnable and not refundable.