

## 2J6C86MGFc

2× 5GNR MIMO, 2.4/5.0/6.0 GHz ISM and GNSS  
Magnetic Mount

### Key Features

#### Cable 1-2: 5GNR

- 617-960 MHz
- 1427-2690 MHz
- 3300-5000 MHz
- 5150-5925 MHz

#### Cable 3: 2.4/5.0/6.0 GHz ISM

- 2410-2490 MHz
- 4920-7125 MHz

#### Cable 4: GPS/GLONASS/QZSS/Galileo

- 1575-1606 MHz

Magnetic Mount

High Performance

Ground Plane Independent

Customizable Cable and Connector

Dimensions: 193 × 76.5 × 56.1 mm

Certificates: IP67, IP69

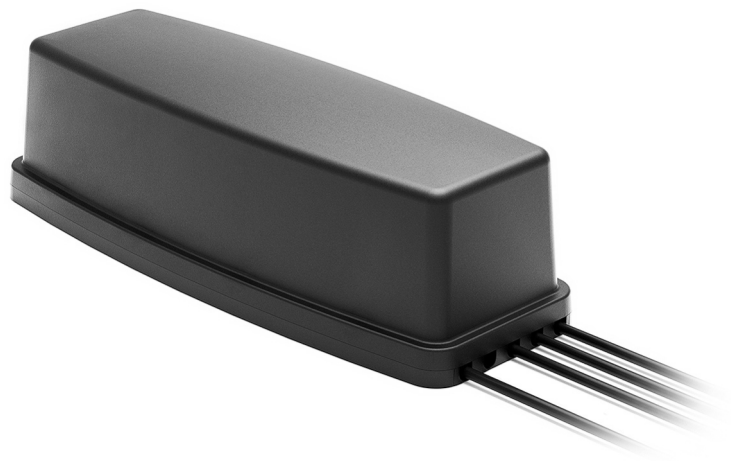

## 1. Antenna and electrical specifications

Cable 1

Parameters	5G NR Antenna			
Technologies	5G, 4G, 3G and 2G			
Standards	5G NR/4G LTE/FirstNet/CBRS/LPWA/CAT-X/CAT-Mx/CAT-NBx/NB-IoT/3G/2G			
Frequency (MHz)	617-960	1427-2690	3300-5000	5150-5925
Band (MHz)	600, 700, 850, 900	1500, 1600, 1700, 1800, 1900, 2000, 2100, 2300, 2500, 2600	3300, 3500, 3600, 3700, 4500	5200, 5500, 5800
5G NR Bands	n5, n8, 12, n20, n28, n71, n81, n82, n83,	n1, n2, n3, n7, n25, n34, n38, n39, n40, n41, n50, n51, n66, n70, n74, n75, n76, n80, n84, n86	n77, n78, n79	
4G LTE Bands	B5, B6, B8, B12, B13, B14, B17, B18, B19, B20, B26, B27, B28, B29, B44, B67, B68, B71, B85	B1, B2, B3, B4, B7, B9, B10, B11, B21, B23, B24, B25, B30, B32, B33, B34, B35, B36, B37, B38, B39, B40, B41, B45, B50, B51, B65, B66, B69, B70, B74, B75, B76	B22, B42, B43, B48, B49, B52	B46, B47, B252, B255
3G CELL Bands	B5, B6, B8, B12, B13, B14, B19, B20, B26	B1, B2, B3, B4, B7, B9, B10, B11, B21, B25, B32, B33, B34, B35, B36, B37, B38, B39, B40	B22	
2G CELL Bands	710, 750, 810T, 850, 900P, 900E, 900R	1800DCS, 1900PCS		
CDMA CELL Bands	BC0, BC2, BC3, BC7, BC9, BC10, BC12, BC18, BC19	BC1, BC4, BC6, BC8, BC13, BC14, BC15, BC16, BC20, BC21		
Return Loss (dB)	~-6.9	~-15.9	~-15.0	~-6.7
VSWR	~2.7:1	~1.5:1	~1.6:1	~2.8:1
Efficiency (%)	~40.2	~47.3	~35.3	~22.1
Peak Gain (dBi)	~2.5	~5.0	~4.8	~3.3
Average Gain (dB)	~-4.0	~-3.3	~-4.8	~-6.7
Impedance (Ohm)	50			
Polarisation	Linear			
Radiation Pattern	Omni-Directional			
Max. Input Power (W)	25			
Connector Type	SMA-Male Standard (Other Connectors Available)			
Cable Length	300 cm Standard (Any Cable Length Available)			
Cable Type	D302 Standard (Other Cables Available)			

**Cable 2**

Parameters	5GNR Antenna			
<b>Technologies</b>	5G, 4G, 3G and 2G			
<b>Standards</b>	5GNR/4GLTE/FirstNet/CBRS/LPWA/CAT-X/CAT-Mx/CAT-NBx/NB-IoT/3G/2G			
<b>Frequency (MHz)</b>	617-960	1427-2690	3300-5000	5150-5925
<b>Band (MHz)</b>	600, 700, 850, 900	1500, 1600, 1700, 1800, 1900, 2000, 2100, 2300, 2500, 2600	3300, 3500, 3600, 3700, 4500	5200, 5500, 5800
<b>5GNR Bands</b>	n5, n8 ,12, n20, n28, n71, n81, n82, n83,	n1, n2, n3, n7, n25, n34, n38, n39, n40, n41, n50, n51, n66, n70, n74, n75, n76, n80, n84, n86	n77, n78, n79	
<b>4GLTE Bands</b>	B5, B6, B8, B12, B13, B14, B17, B18, B19, B20, B26, B27, B28, B29, B44, B67, B68, B71, B85	B1, B2, B3, B4, B7, B9, B10, B11, B21, B23, B24, B25, B30, B32, B33, B34, B35, B36, B37, B38, B39, B40, B41, B45, B50, B51, B65, B66, B69, B70, B74, B75, B76	B22, B42, B43, B48, B49, B52	B46, B47, B252, B255
<b>3GCELL Bands</b>	B5, B6, B8, B12, B13, B14, B19, B20, B26	B1, B2, B3, B4, B7, B9, B10, B11, B21, B25, B32, B33, B34, B35, B36, B37, B38, B39, B40	B22	
<b>2GCELL Bands</b>	710, 750, 810T, 850, 900P, 900E, 900R	1800DCS, 1900PCS		
<b>CDMACELL Bands</b>	BC0, BC2, BC3, BC7, BC9, BC10, BC12, BC18, BC19	BC1, BC4, BC6, BC8, BC13, BC14, BC15, BC16, BC20, BC21		
<b>Return Loss (dB)</b>	~-7.1	~-15.4	~-18.1	~-9.2
<b>VSWR</b>	~2.7:1	~1.5:1	~1.4:1	~2.1:1
<b>Efficiency (%)</b>	~40.7	~46.9	~39.8	~33.8
<b>Peak Gain (dBi)</b>	~2.5	~5.0	~5.4	~4.4
<b>Average Gain (dB)</b>	~-4.0	~-3.3	~-4.1	~-4.8
<b>Impedance (Ohm)</b>	50			
<b>Polarisation</b>	Linear			
<b>Radiation Pattern</b>	Omni-Directional			
<b>Max. Input Power (W)</b>	25			
<b>Connector Type</b>	SMA-Male Standard (Other Connectors Available)			
<b>Cable Length</b>	300 cm Standard (Any Cable Length Available)			
<b>Cable Type</b>	D302 Standard (Other Cables Available)			

**Antenna Measurement Conditions:**

Mounted on Metal Plate of 30 x 30 cm  
 100 cm of Cable D302  
 Measured in Certified CTIA 3D Anechoic Chamber

**Cable 3**

Parameters	2.4/5.0/6.0 GHz ISM Antenna		
<b>Standards</b>	WiFi, BT, ZigBee, ISM, <b>Sigfox, LoRa</b>		
<b>Band (MHz)</b>	2.4GHz	5.0 GHz	6.0GHz
<b>Frequency (MHz)</b>	2410-2490	4920-5925	5925-7125
<b>Return Loss (dB)</b>	~-16.7	~-18.6	~-12.3
<b>VSWR</b>	~1.5:1	~1.3:1	~1.8:1
<b>Efficiency (%)</b>	~49.2	~48.2	~32.1
<b>Peak Gain (dBi)</b>	~4.2	~6.4	~5.3
<b>Average Gain (dB)</b>	~-3.1	~-3.2	~-3.8
<b>Impedance (Ohm)</b>	50		
<b>Polarisation</b>	Linear		
<b>Radiation Pattern</b>	Omni-Directional		
<b>Max. Input Power (W)</b>	25		
<b>Connector Type</b>	SMA-Male-RP Standard (Other Connectors Available)		
<b>Cable Length</b>	300 cm Standard (Any Cable Length Available)		
<b>Cable Type</b>	D302 Standard (Other Cables Available)		

**Cable 4**

Parameters	GPS/GLONASS Antenna	
<b>Standards</b>	GPS/QZSS/Galileo	GLONASS
<b>Band (MHz)</b>	1575	1602
<b>Frequency(MHz)</b>	1575.42	1598-1610
<b>Patch Size (mm)</b>	25 x 25 x 4	
<b>Return Loss (dB)</b>	<=-15.0 dB	
<b>VSWR</b>	<=1.4:1 dB	
<b>Impedance</b>	50	
<b>Radiation Pattern</b>	Hemispherical	
<b>Polarization</b>	RHCP	
<b>Saw Filter</b>	Pre-filter	
<b>Active Gain (dB)</b>	28 @ 2.7 V	
<b>Noise Figure (dB)</b>	1.5 Typ	
<b>Voltage (V)</b>	1.5 - 3.6	
<b>Current Consumption (mA)</b>	9 Typ	
<b>Power Consumption (mW)</b>	24.3 Typ	
<b>ESD Protection (kV)</b>	2kV	
<b>Connector Type</b>	SMA-Male Standard (Other Connectors Available)	
<b>Cable Length</b>	300 cm Standard (Any Cable Length Available)	
<b>Cable Type</b>	LL100 Standard (Other Cables Available)	

**Antenna Measurement Conditions:**

Mounted on Metal Plate of 30 x 30 cm  
 100 cm of Cable D302  
 Measured in Certified CTIA 3D Anechoic Chamber

## 2. Mechanical and environmental specifications

Specifications	2J6C86MGFc
<b>Mounting Type</b>	Magnetic Mount
<b>Dimensions (mm)</b>	193 × 76.5 × 56.1
<b>Radome Type</b>	ASA
<b>Radome color</b>	Black, White
<b>Operating Temperature (C)</b>	-40 to +85
<b>Storage Temperature (C)</b>	-40 to +85
<b>Substance Compliance</b>	RoHS
<b>Certificates</b>	IP67, IP69

### 3. Antenna parameters

**Cable 1: 5GNR**

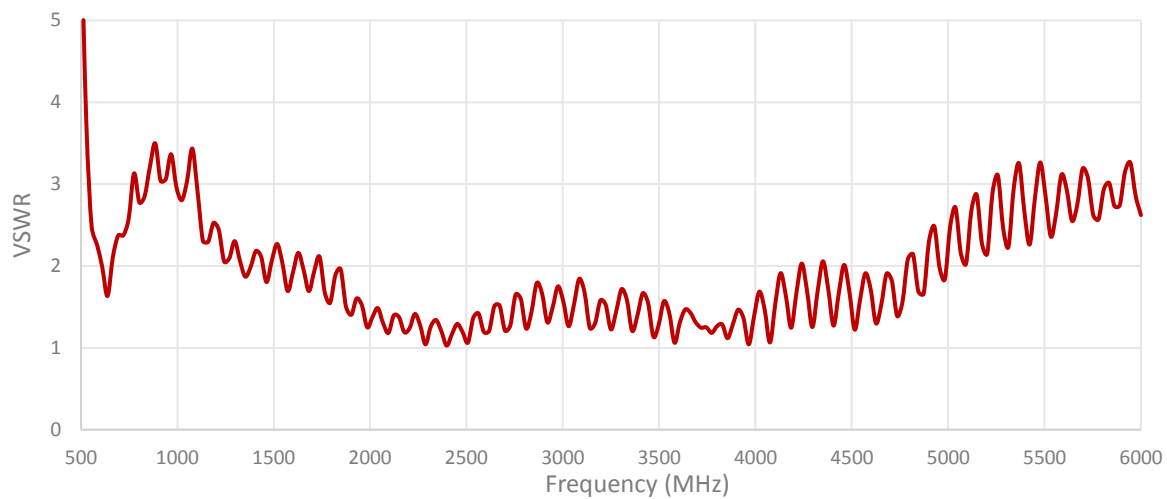
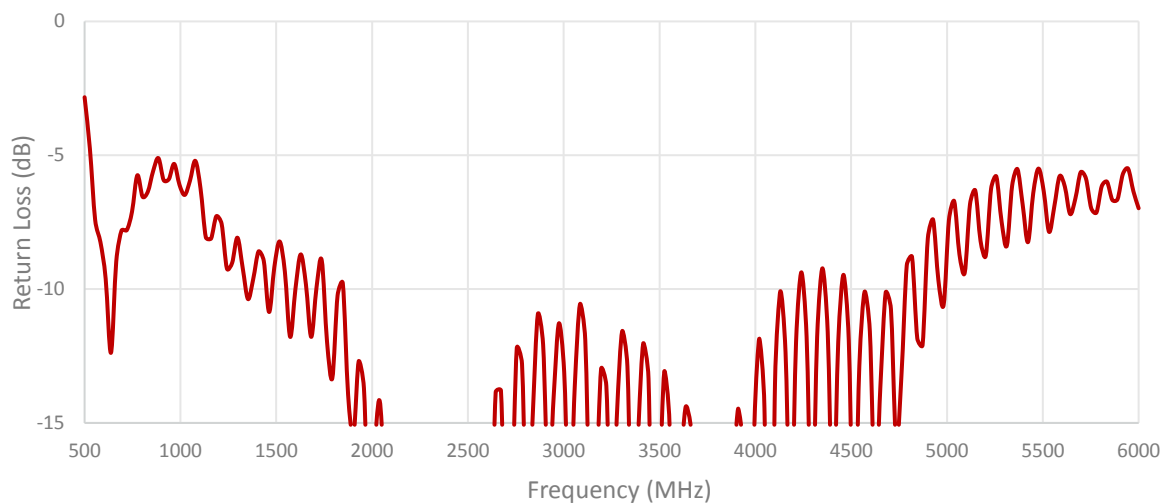

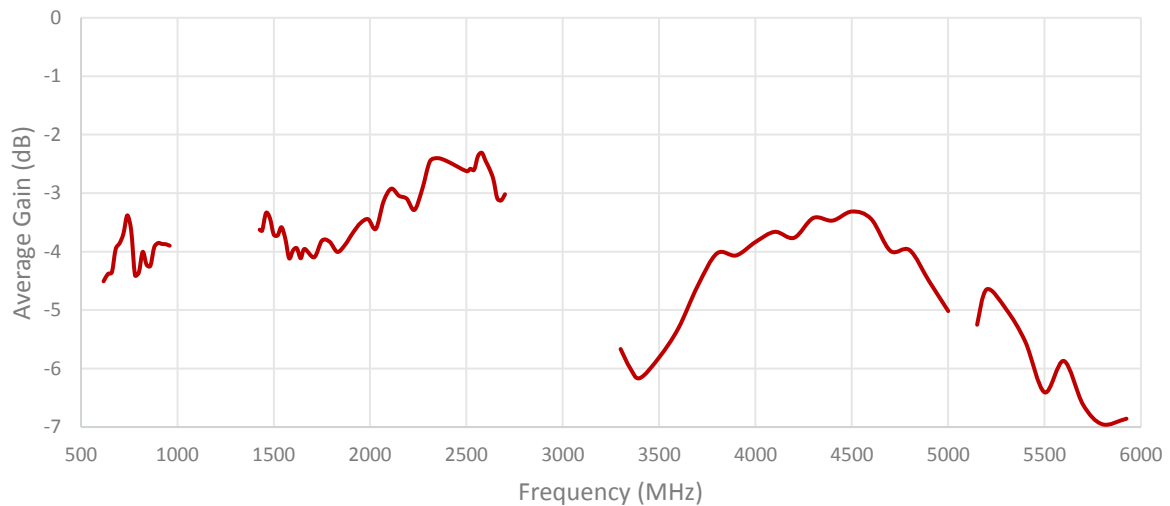
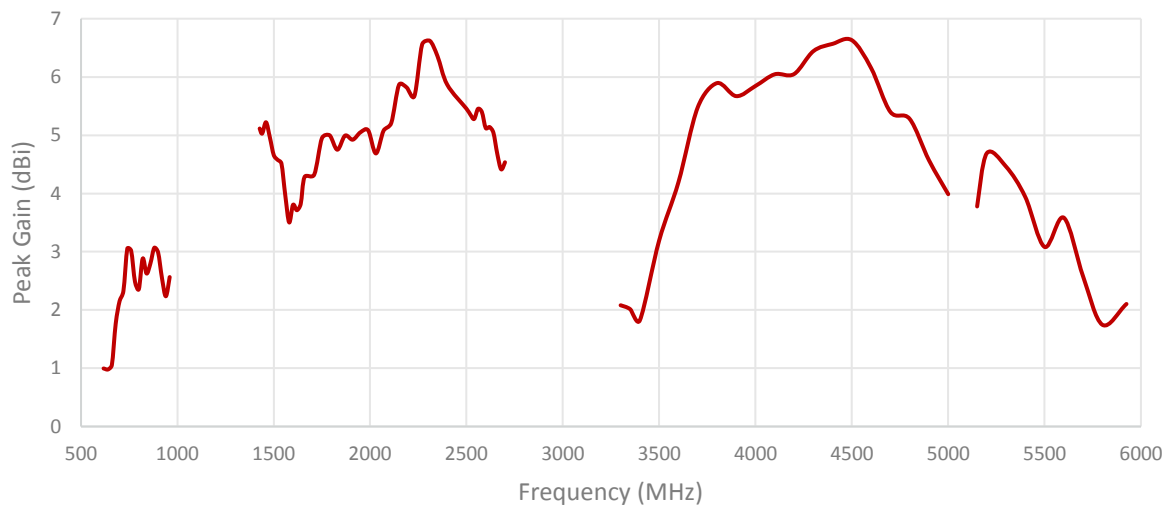
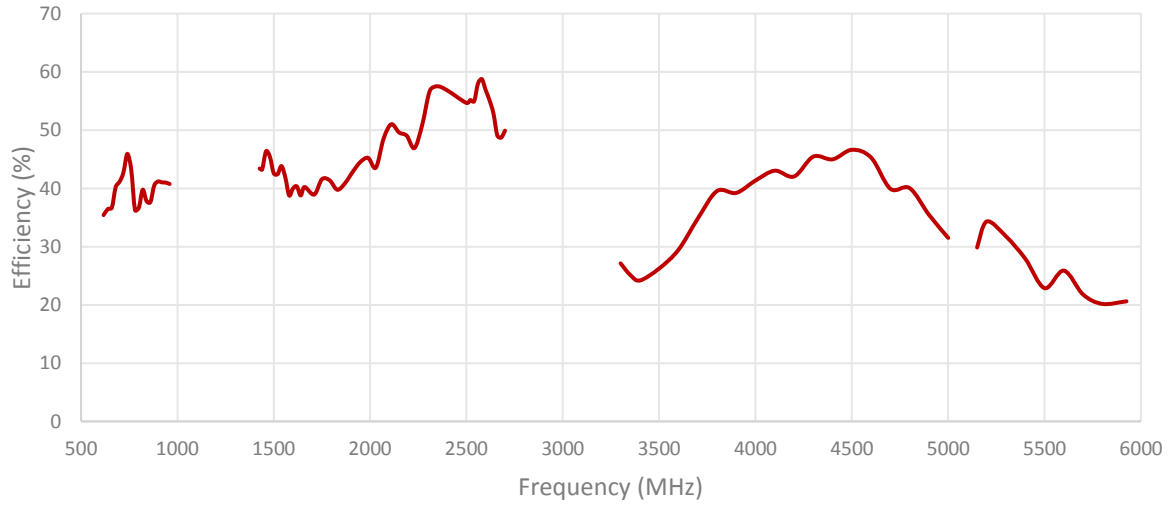

**Cable 2: 5G NR**

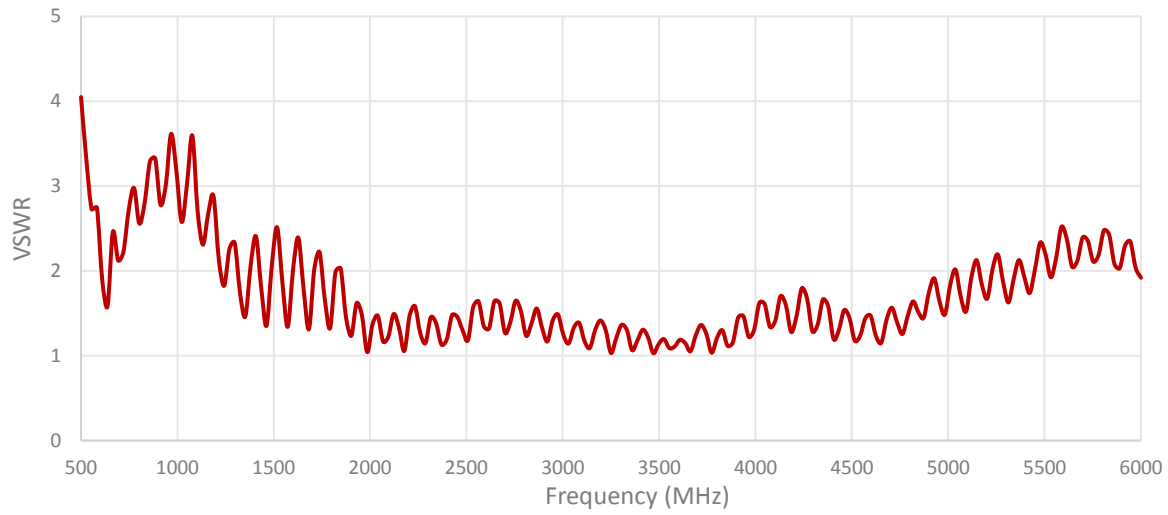
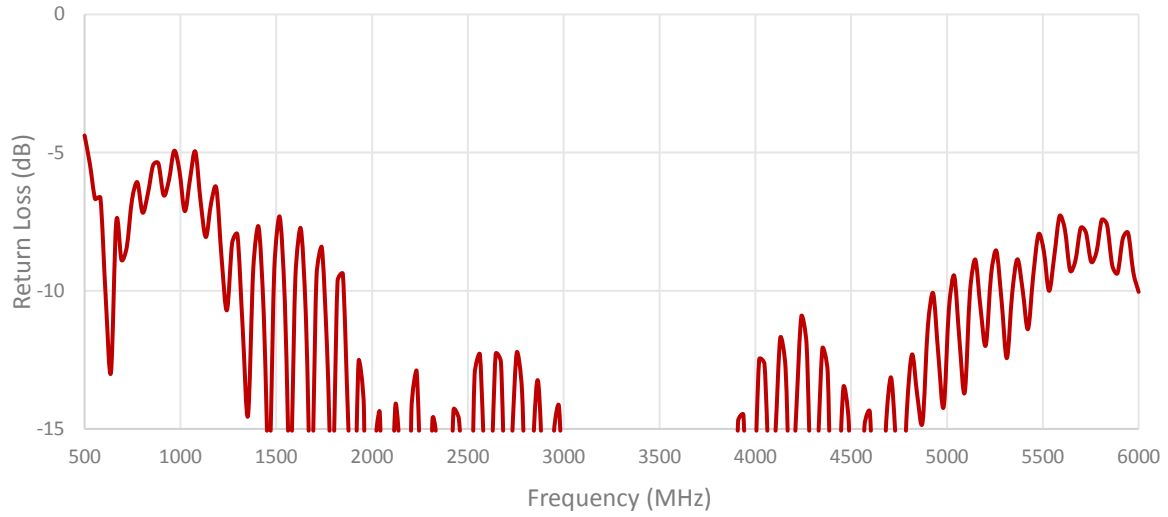



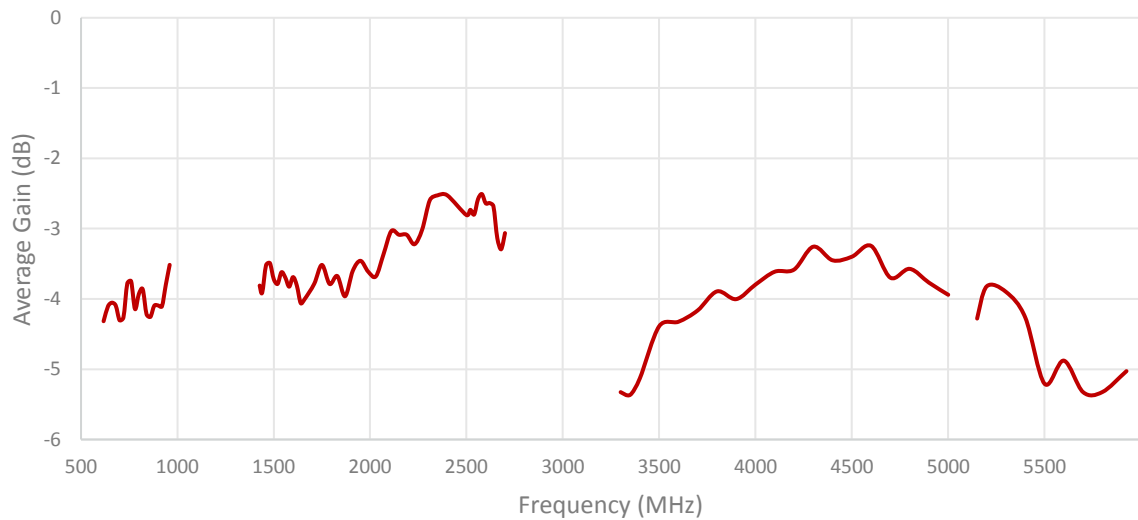
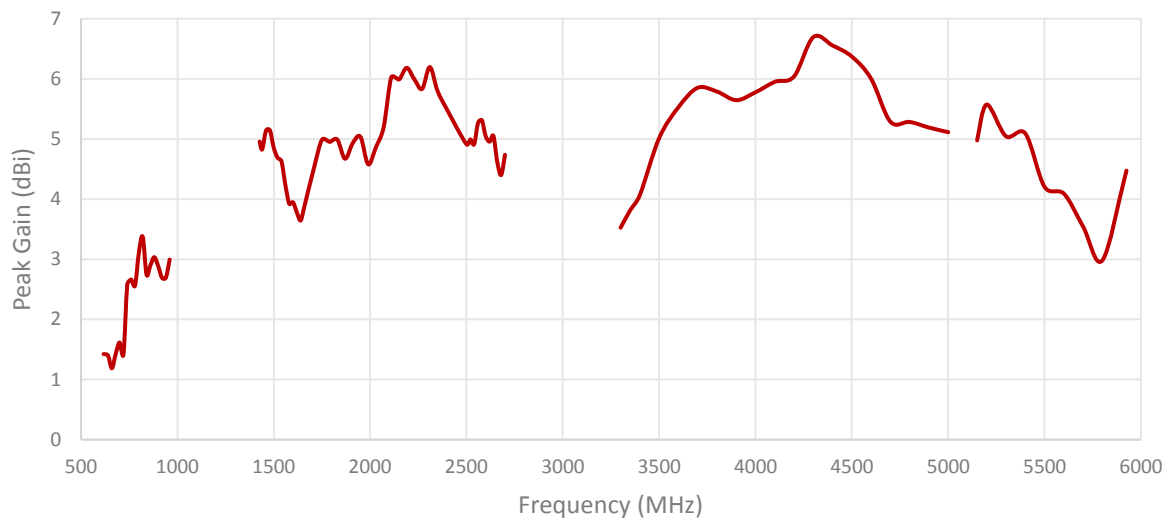
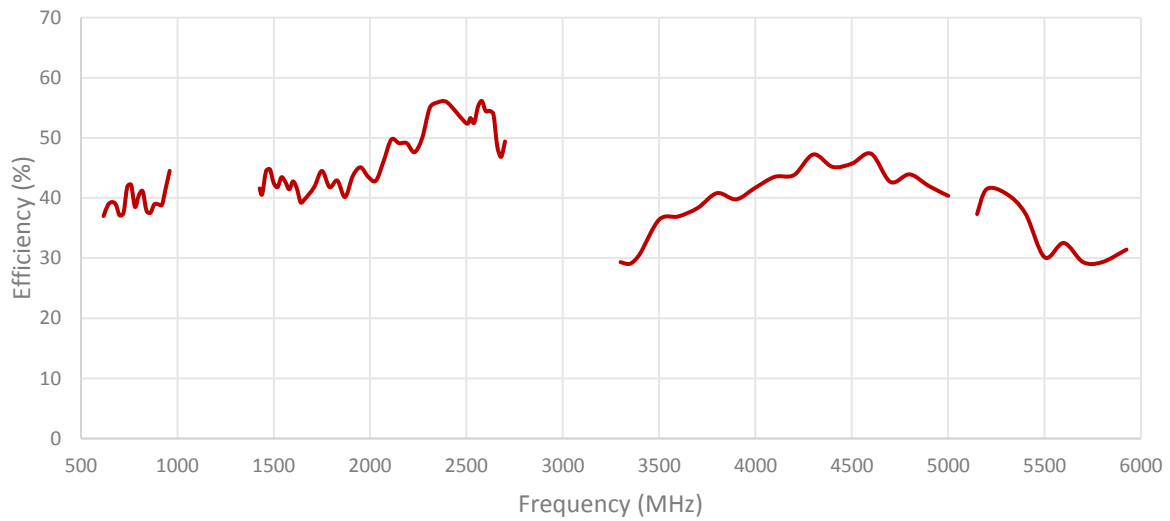

**ISOLATION FOR CABLES 1 AND 2**

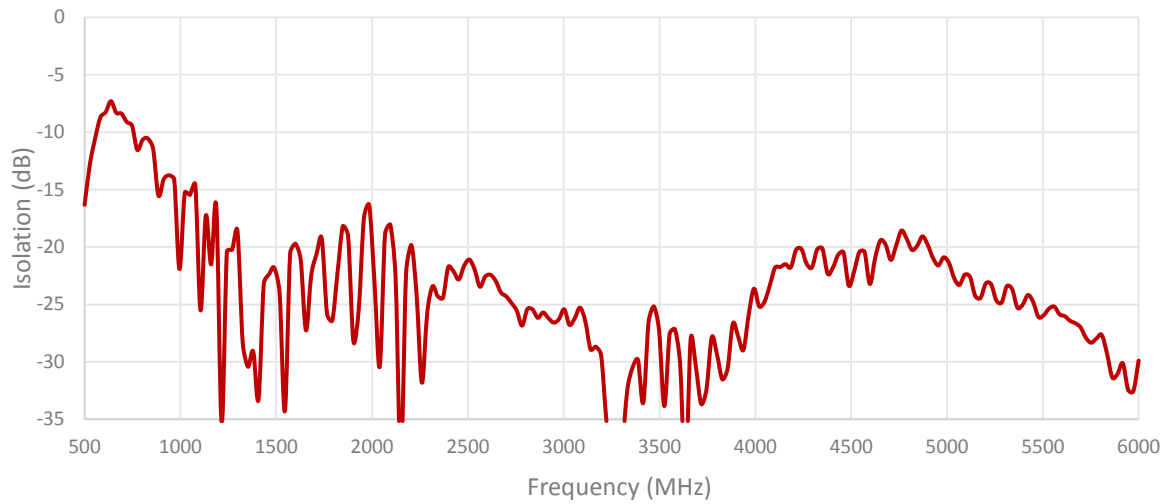

**ENVELOPE CORRELATION COEFFICIENT FOR CABLES 1 AND 2**

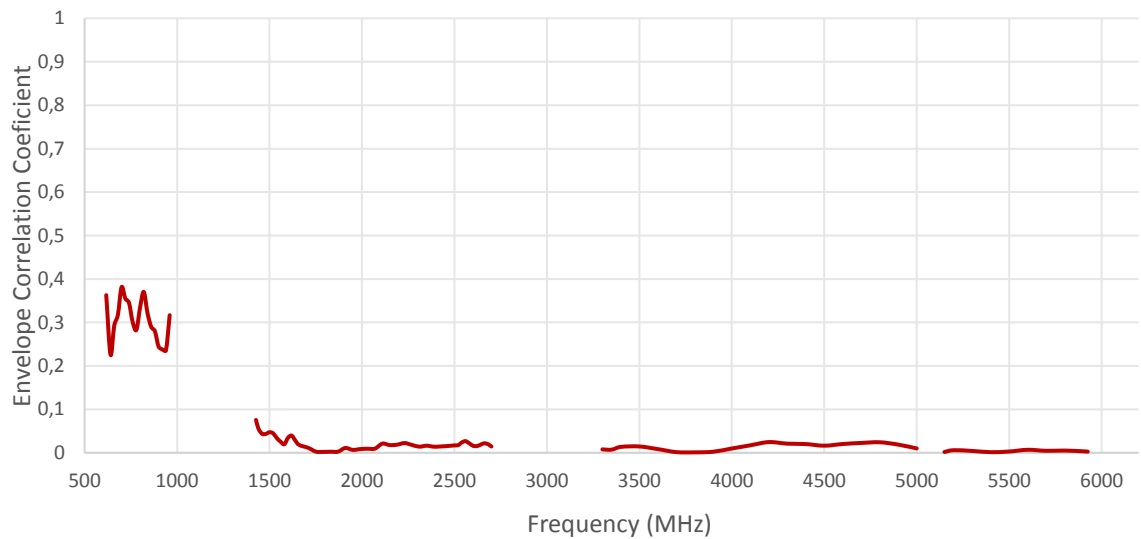

**Cable 3: 2.4/5.0/6.0 GHz ISM**

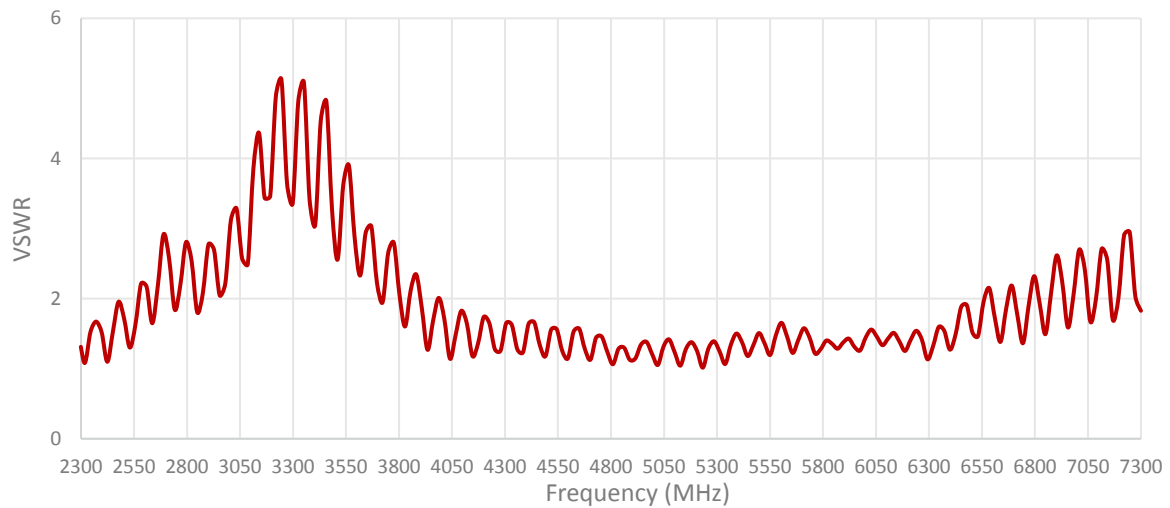
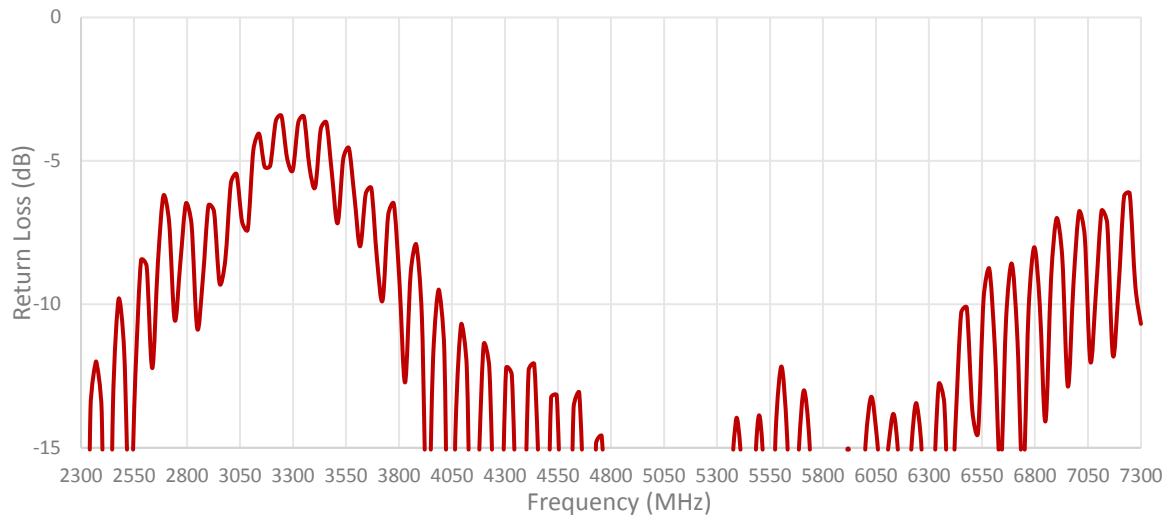

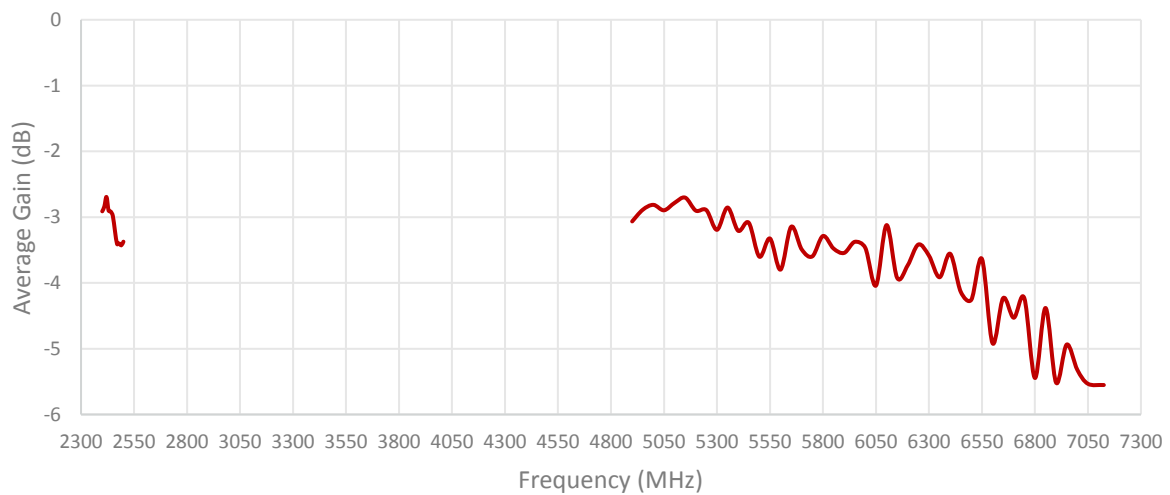
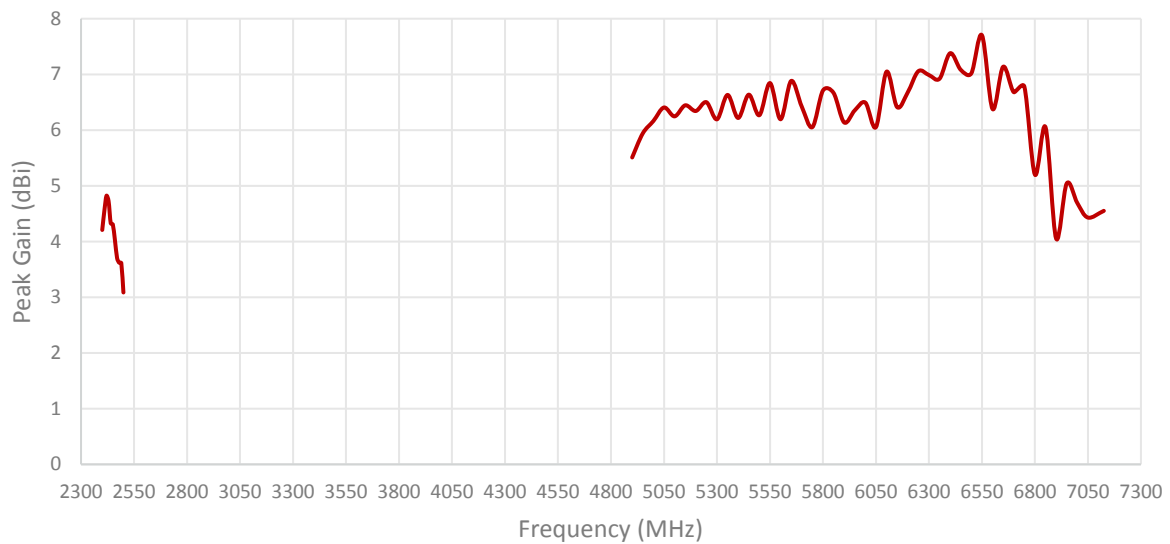
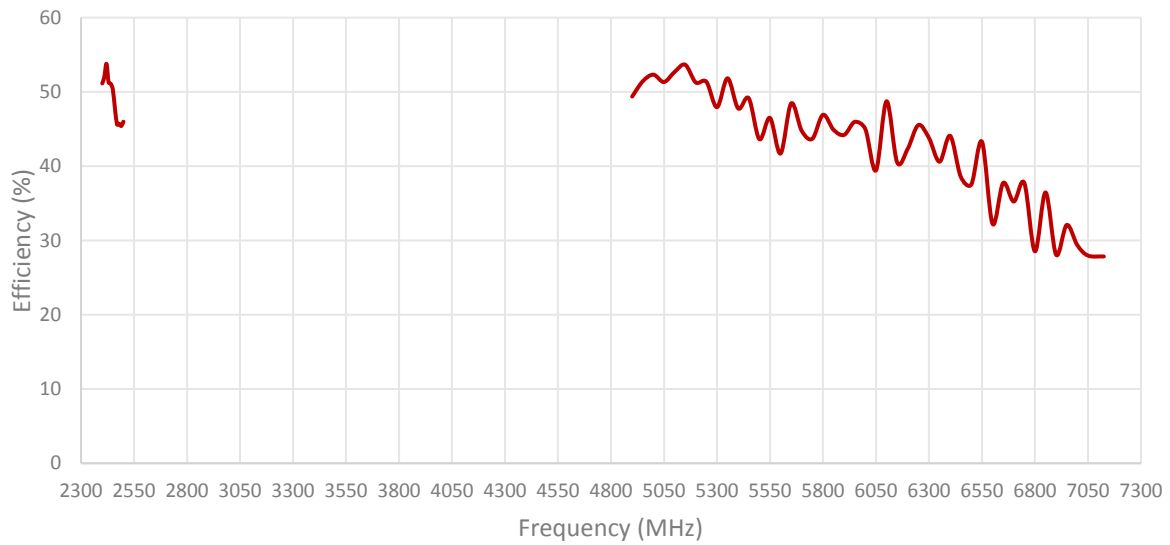

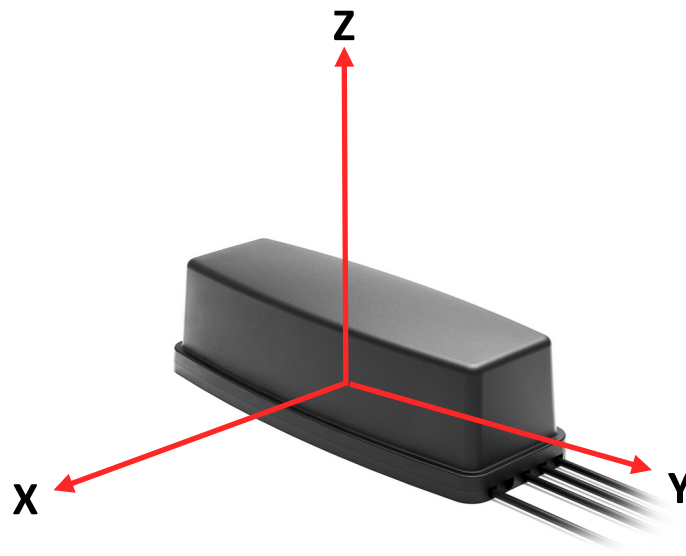

Radiation pattern reference

Cable 1: 5GNR

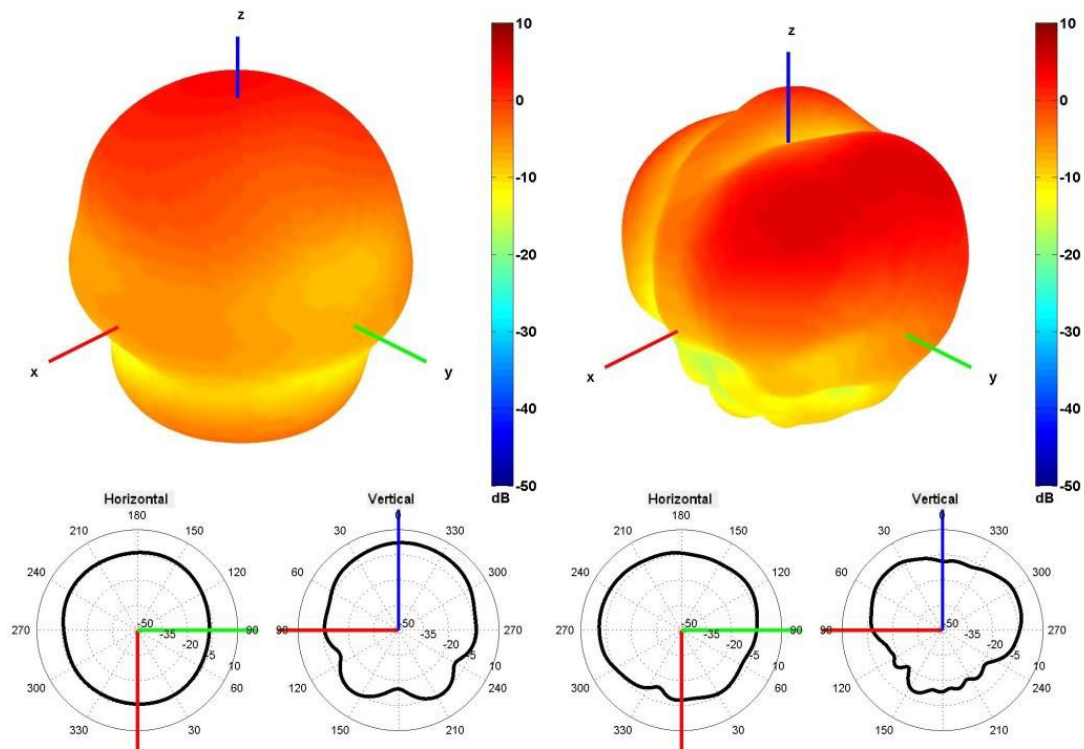

740 and 2500 MHz Radiation pattern

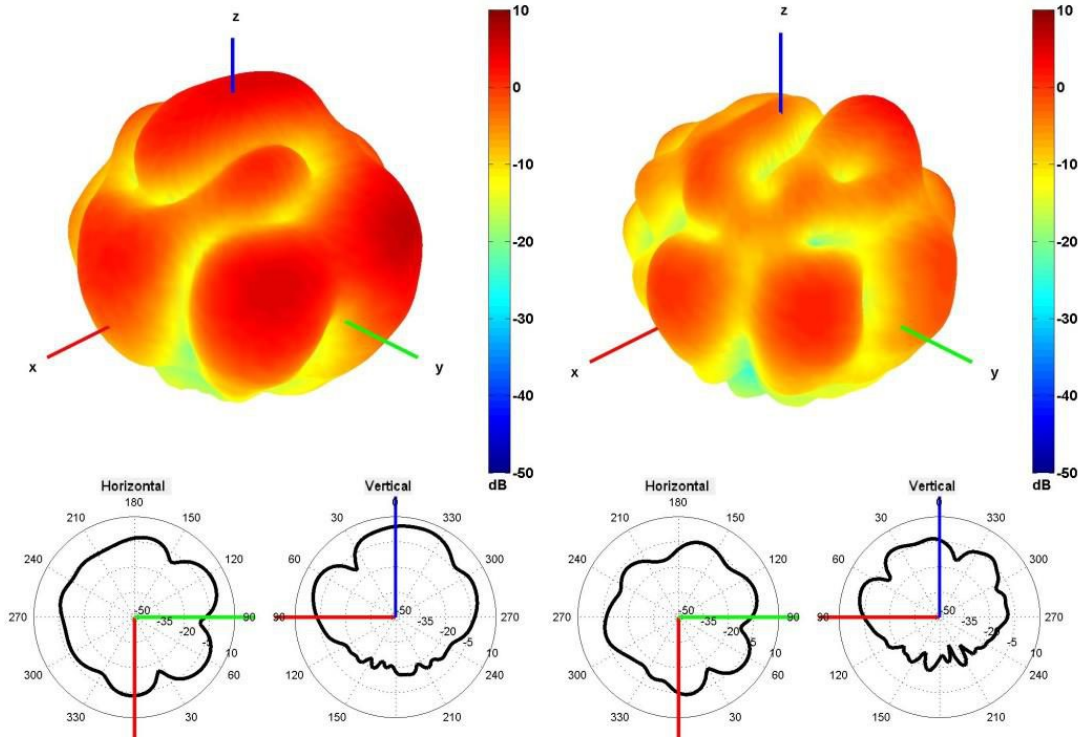

450 and 550 MHz Radiation pattern

Cable 2: 5GNR

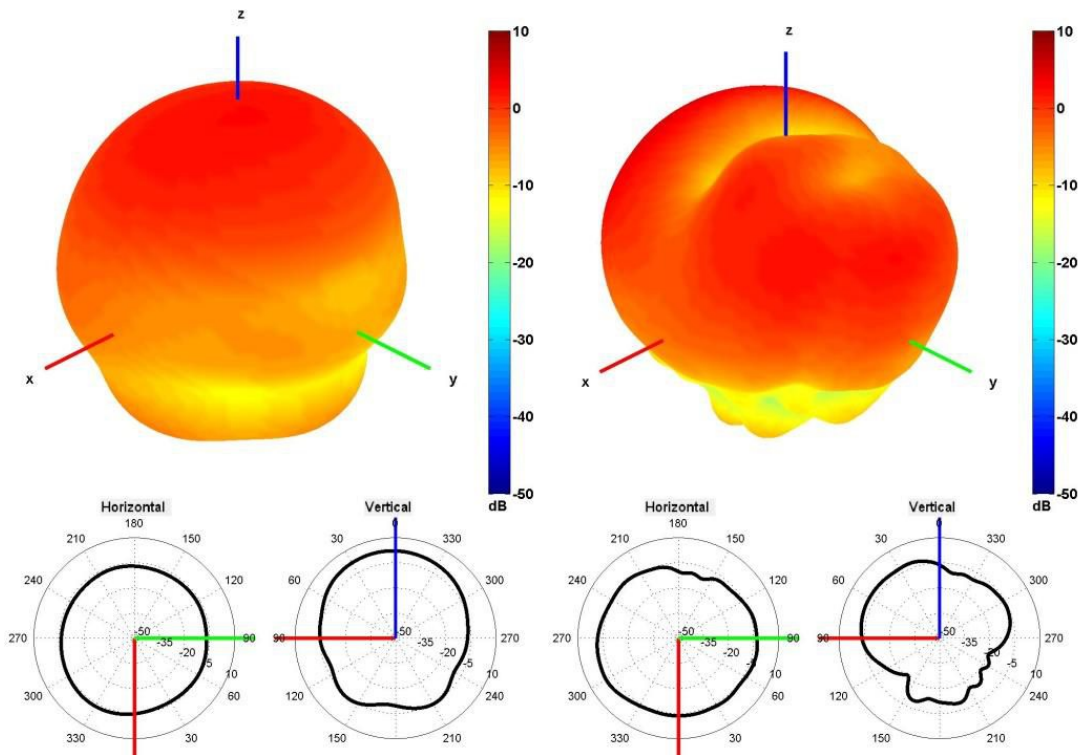

740 and 2500 MHz Radiation pattern

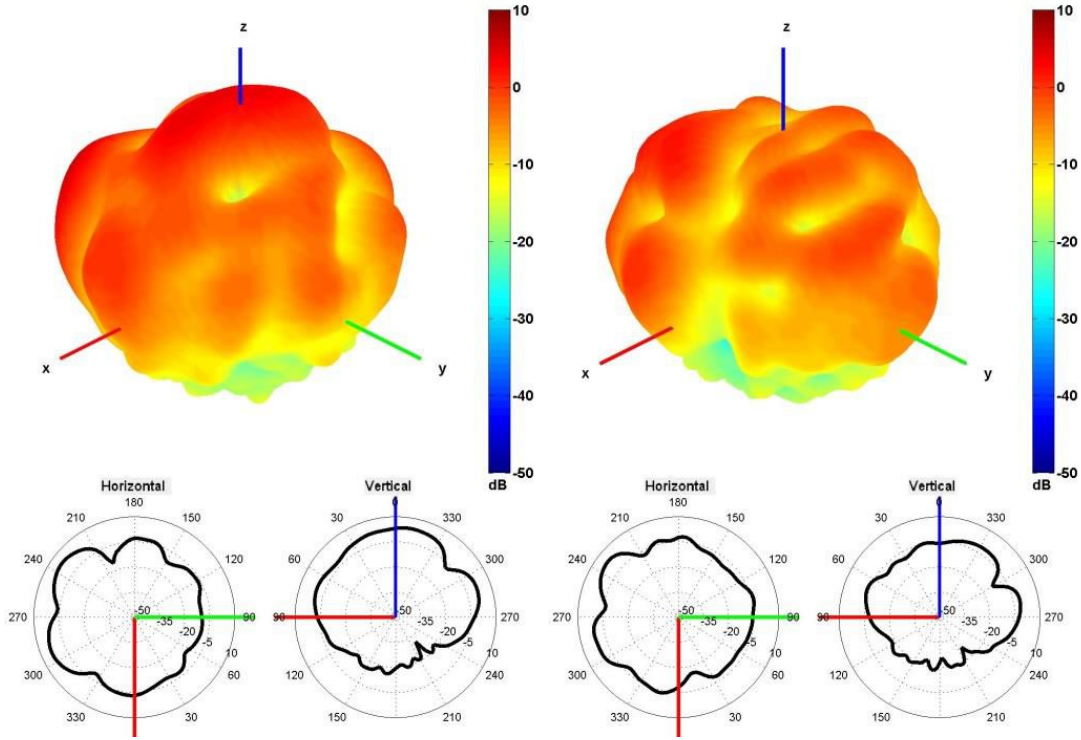

4500 and 5500 MHz Radiation pattern

Cable 3: 2.4/5.0/6.0 GHz ISM

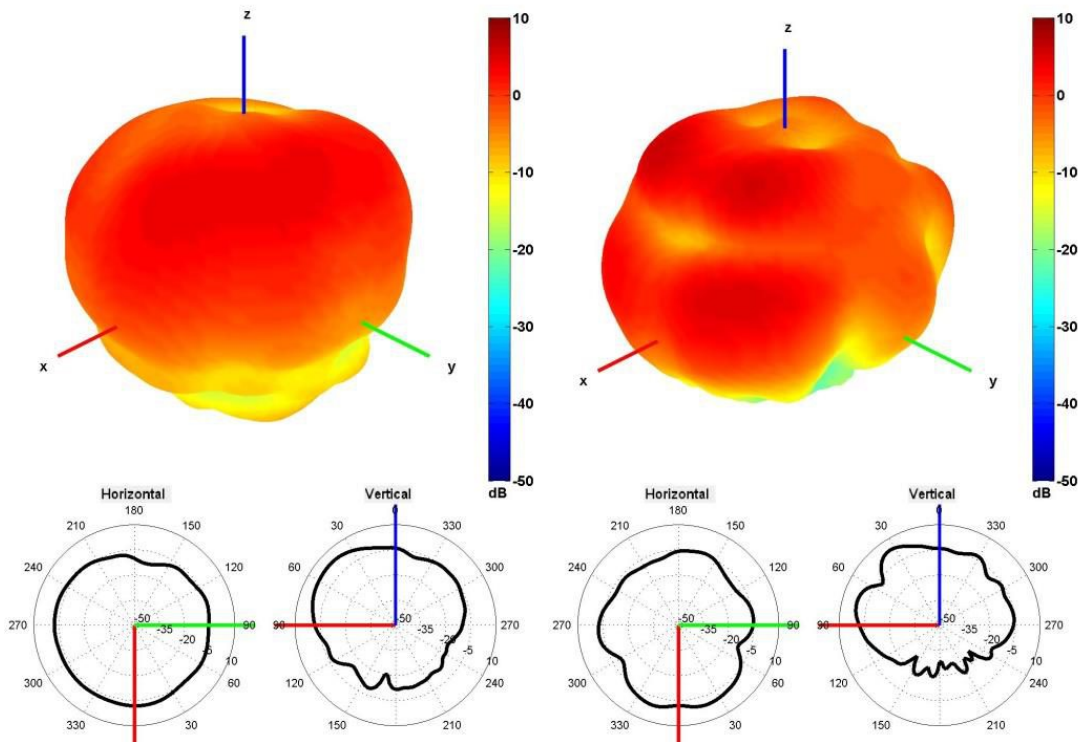

2450 and 5500 MHz Radiation pattern

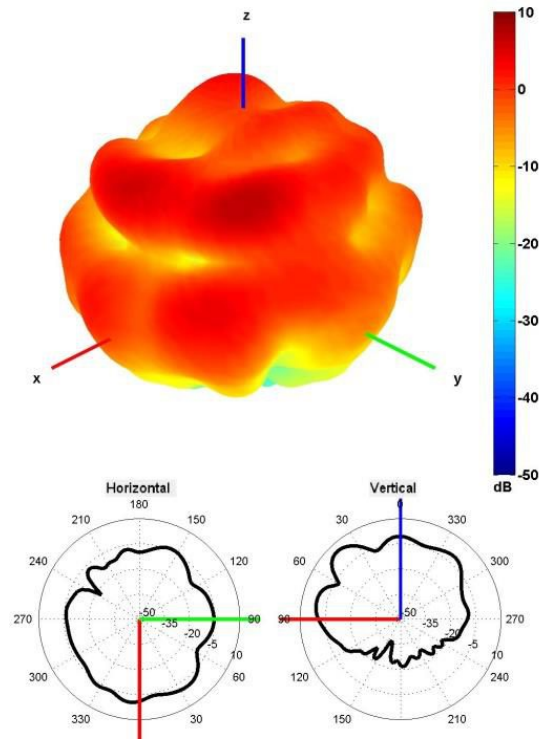

6500 MHz Radiation pattern



## 4. Antenna drawings

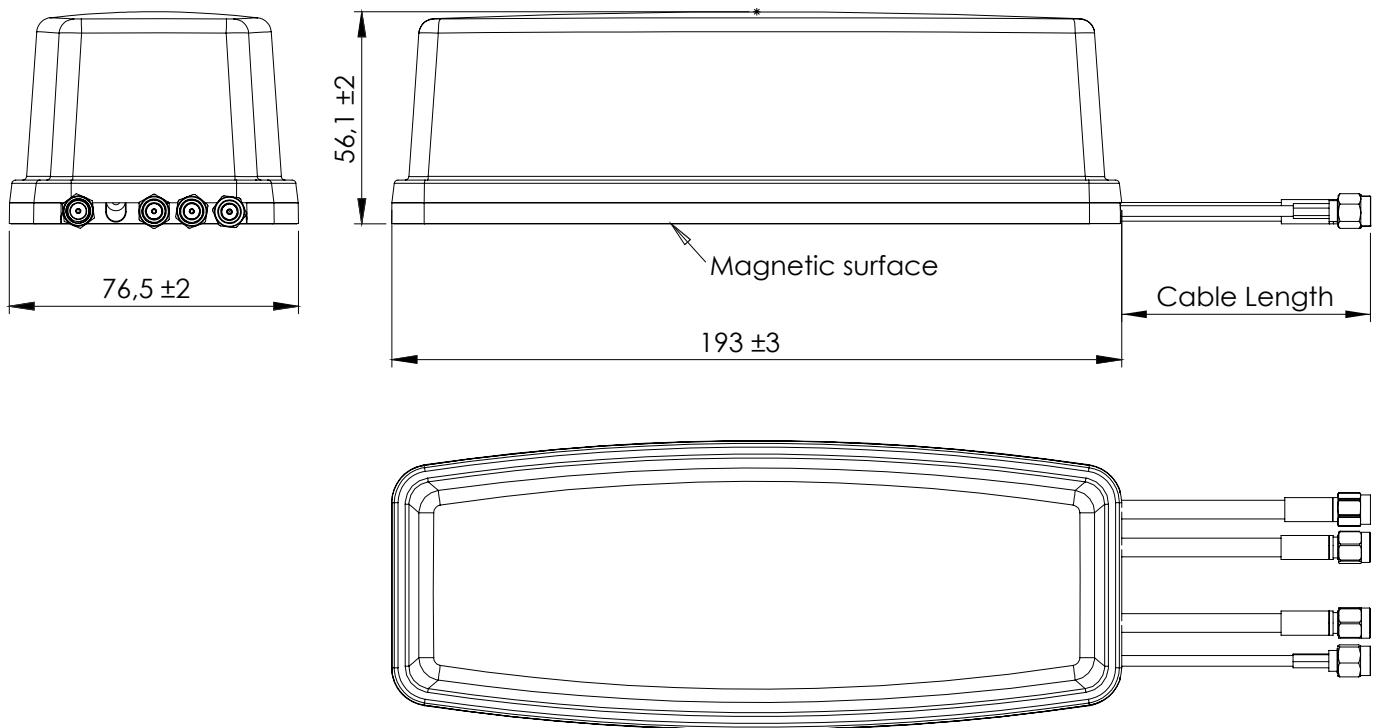

**Note: Dimensions are in millimeters**  
**\*Dimensions are after mounting**

## 5. Antenna Images

