

# SERPAC 2003, DB9 for A20

Electronic Enclosures

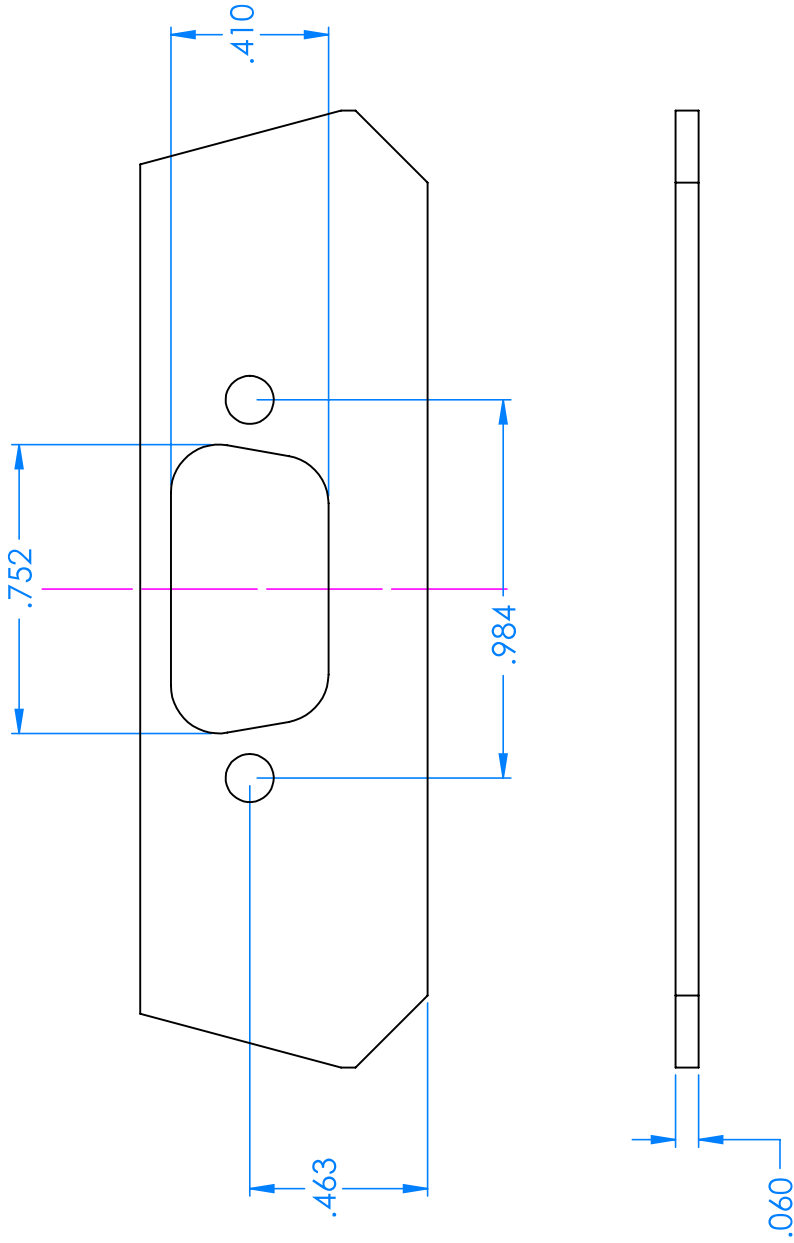

**NOTES:**  
Cutout located to accept a D-sub standard surface mount DB9 connector  
(male or female) using a .065" thick circuit board.