

# 10.0 x 3.2 x 0.5 (mm) ISM Ceramic Chip Antenna (AA066)

## Engineering Specification

### 1. Explanation of Product Number

H 2 U 6 4 6 M H L Q 0 2 0 0



### 2. Features

- \*Stable and reliable in performances
- \*Low temperature coefficient of frequency
- \*Low profile, compact size
- \*RoHS 2.0 compliance
- \*SMT processes compatible
- \*AEC-Q200 compliant

### 3. Applications

- \*ISM Band system.
- \*RFID system

### 4. Description

Unictron's chip antenna series are specially designed for ISM Band applications. Based on Unictron's proprietary design and processes, this chip antenna has excellent stability and sensitivity to consistently provide high signal reception efficiency.



詠業科技股份有限公司  
Unictron Technologies Corporation  
Website: www.unictron.com

THIS DRAWINGS AND SPECIFICATIONS ARE THE PROPERTY OF UNICTRON TECHNOLOGIES CORPORATION AND SHALL NOT BE REPRODUCED OR USED AS THE BASIS FOR THE MANUFACTURE OR SALE OF APPARATUS OR DEVICES WITHOUT PERMISSION

Prepared by : Betty

Designed by : Sam

Checked by : Mike

Approved by : Herbert

TITLE : 10.0 x 3.2 x 0.5 (mm) ISM Ceramic Chip Antenna (AA066) Engineering Specification

DOCUMENT NO.

H2U646MHLQ0200

REV. K

## 5. Electrical Specifications (80x40(mm) ground plane)

### 5-1. Electrical Table:

Characteristics		Specifications	Unit
Outline Dimensions		10x3.2x0.5	mm
Ground Plane		80x40	mm
Working Frequency		902~928	MHz
VSWR (@ center frequency)*		2 Max.	
Characteristic Impedance		50	$\Omega$
Polarization		Linear Polarization	
Peak Gain	(@915MHz)	0.9 (typical**)	dBi
Efficiency		69 (typical**)	%

\*Center frequency means the frequency with the lowest value in return loss of the chip antenna on the evaluation board..

\*\*A typical value is for reference only, not guaranteed.

### 5-2. Return Loss & VSWR

Return Loss ( $S_{11}$ )

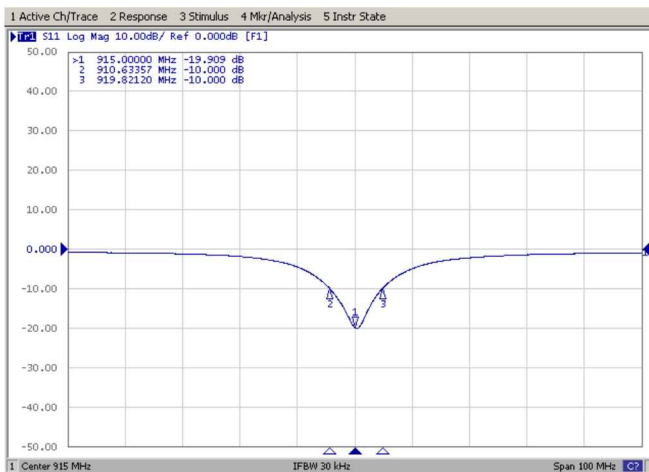

VSWR ( $S_{11}$ )

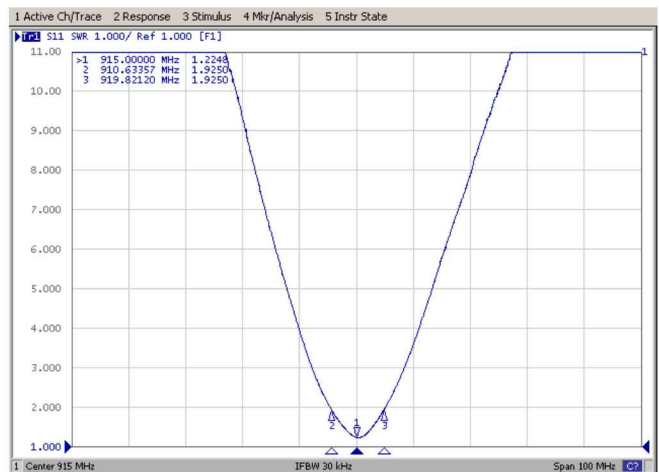

詠業科技股份有限公司  
Unictron Technologies Corporation  
Website: www.unictron.com

THIS DRAWINGS AND SPECIFICATIONS ARE THE PROPERTY OF UNICTRON TECHNOLOGIES CORPORATION AND SHALL NOT BE REPRODUCED OR USED AS THE BASIS FOR THE MANUFACTURE OR SALE OF APPARATUS OR DEVICES WITHOUT PERMISSION

Prepared by : Betty

Designed by : Sam

Checked by : Mike

Approved by : Herbert

TITLE : 10.0 x 3.2 x 0.5 (mm) ISM Ceramic Chip Antenna (AA066) Engineering Specification

DOCUMENT NO.

H2U646MHLQ0200

REV. K

## 6. Antenna Dimensions & Test Board (unit: mm)

### 6-1. Antenna Dimensions

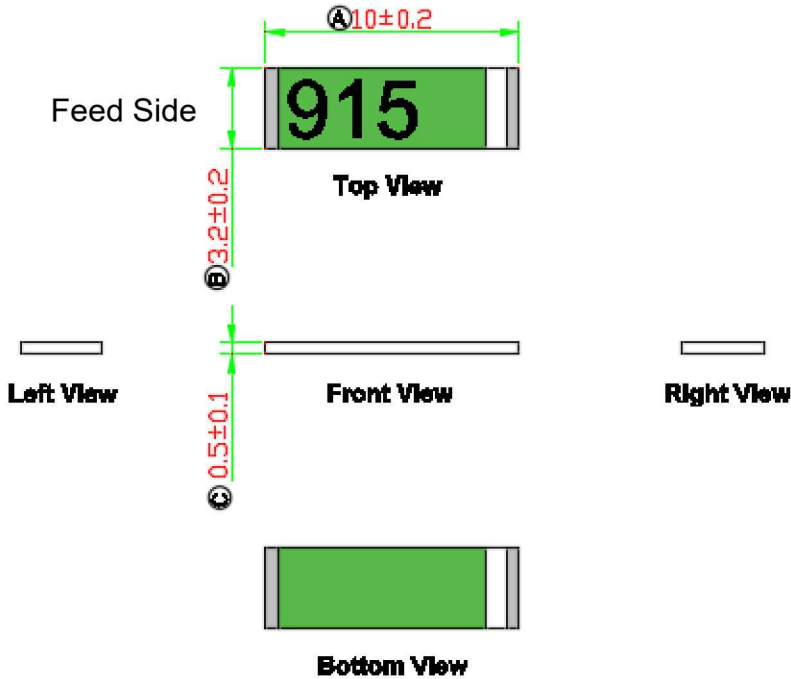

**NOTE:**

1. All materials are RoHS 2.0 compliant.
2. "A"~"C" Critical Dimensions.
3. "( )" Reference Dimensions.

### PIN Definitions



PIN	1	2
Soldering PAD	Signal	Tuning / Ground



詠業科技股份有限公司  
Unictron Technologies Corporation  
Website: www.unictron.com

THIS DRAWINGS AND SPECIFICATIONS ARE THE PROPERTY OF UNICTRON TECHNOLOGIES CORPORATION AND SHALL NOT BE REPRODUCED OR USED AS THE BASIS FOR THE MANUFACTURE OR SALE OF APPARATUS OR DEVICES WITHOUT PERMISSION

Prepared by : Betty

Designed by : Sam

Checked by : Mike

Approved by : Herbert

TITLE : 10.0 x 3.2 x 0.5 (mm) ISM Ceramic Chip  
Antenna (AA066) Engineering Specification

DOCUMENT  
NO.

H2U646MHLQ0200

REV.  
K

6-2. Test Board with Antenna

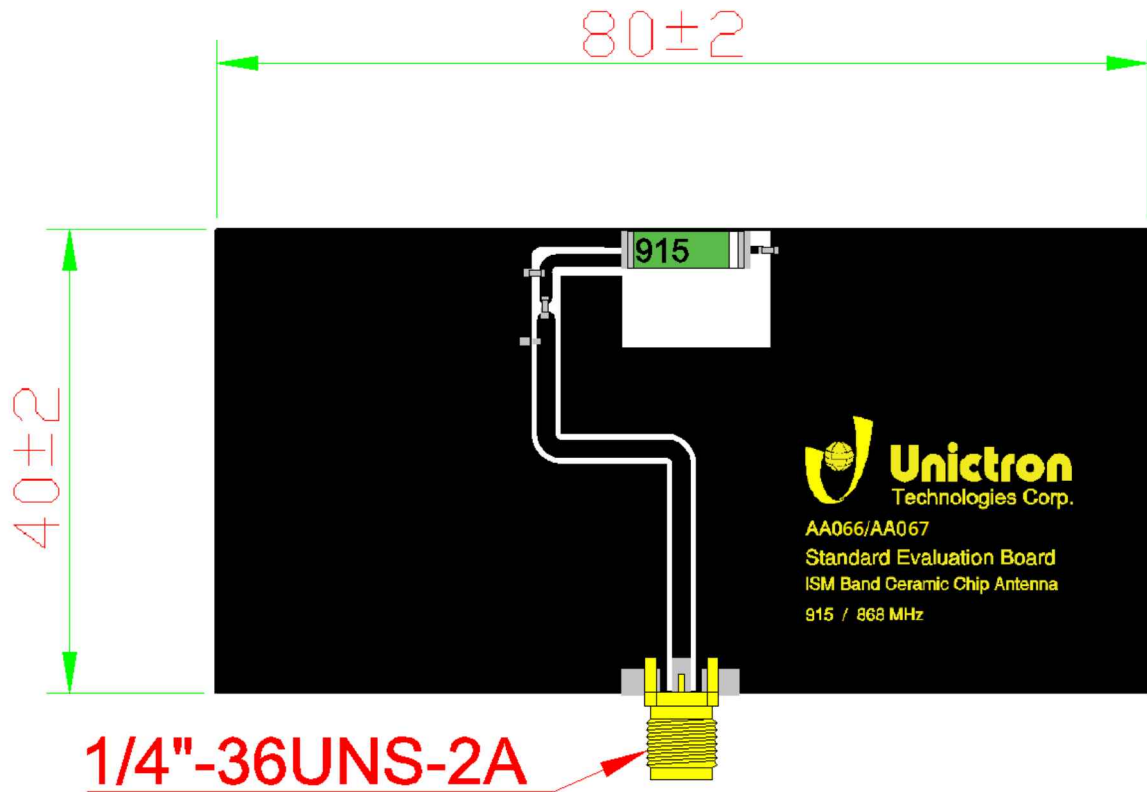

Unit : mm



詠業科技股份有限公司  
 Unictron Technologies Corporation  
 Website:www.unictron.com

THIS DRAWINGS AND SPECIFICATIONS ARE THE PROPERTY OF UNICTRON TECHNOLOGIES CORPORATION AND SHALL NOT BE REPRODUCED OR USED AS THE BASIS FOR THE MANUFACTURE OR SALE OF APPARATUS OR DEVICES WITHOUT PERMISSION

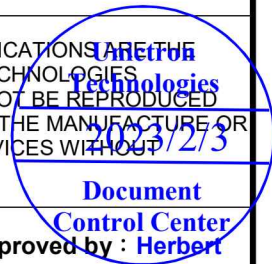

Prepared by : Betty      Designed by : Sam      Checked by : Mike      Approved by : Herbert

TITLE : 10.0 x 3.2 x 0.5 (mm) ISM Ceramic Chip Antenna (AA066) Engineering Specification	DOCUMENT NO.	H2U646MHLQ0200	REV.
			K

# 7. Radiation Pattern (80x40(mm) ground plane)

## 7-1. 3D Gain Pattern (Radiation Pattern at 915 MHz)

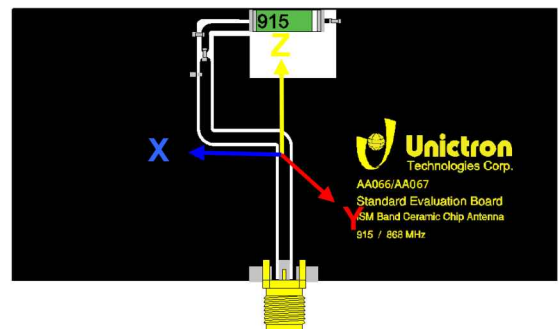
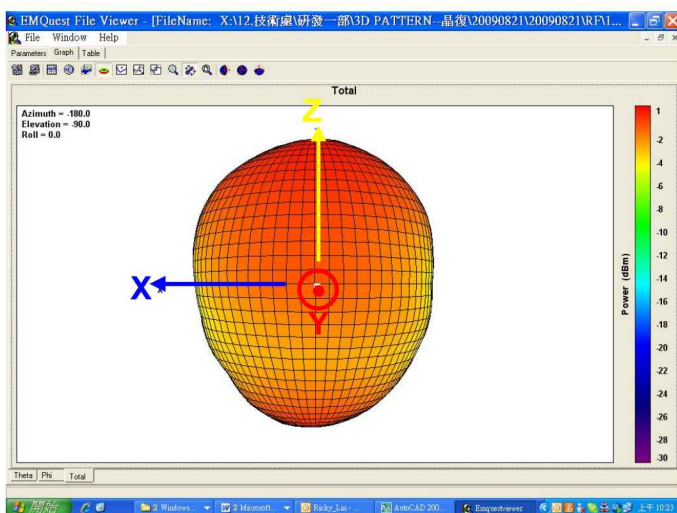
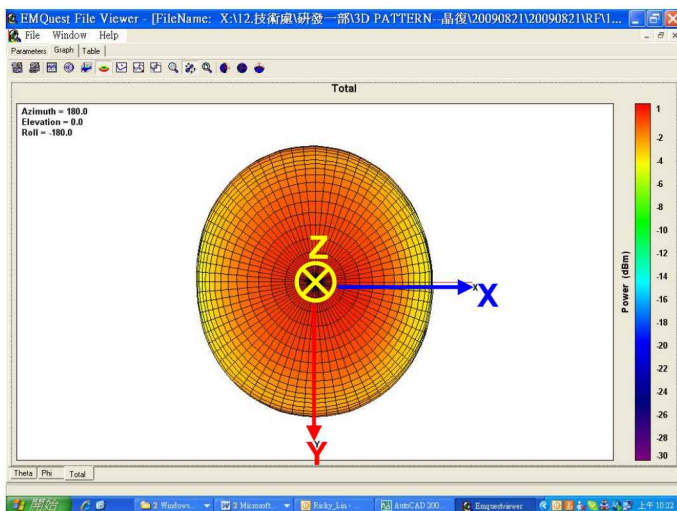
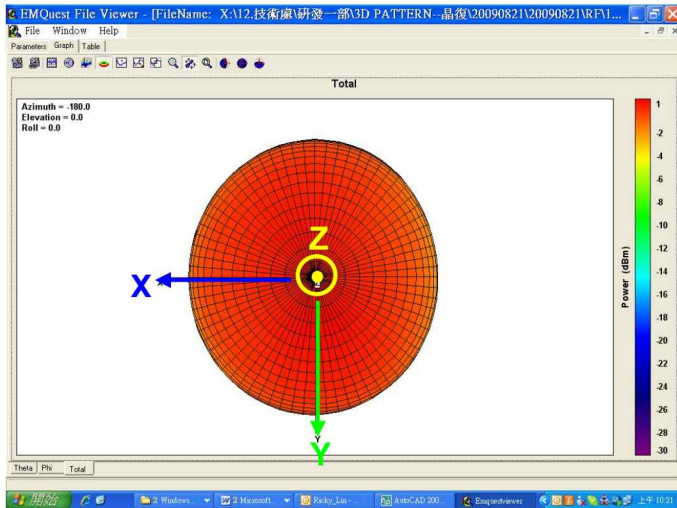

詠業科技股份有限公司  
Unictron Technologies Corporation  
Website: www.unictron.com

THIS DRAWINGS AND SPECIFICATIONS ARE THE PROPERTY OF UNICTRON TECHNOLOGIES CORPORATION AND SHALL NOT BE REPRODUCED OR USED AS THE BASIS FOR THE MANUFACTURE OR SALE OF APPARATUS OR DEVICES WITHOUT PERMISSION

Prepared by : Betty

Designed by : Sam

Checked by : Mike

Approved by : Herbert

TITLE : 10.0 x 3.2 x 0.5 (mm) ISM Ceramic Chip Antenna (AA066) Engineering Specification

DOCUMENT NO.

H2U646MHLQ0200

REV.

K

### 7-2. 3D Efficiency Table

Frequency(MHz)	902	903	904	905	906	907	908	909	910	911	912	913	914	915
Efficiency (dB)	-5.33	-4.96	-4.57	-4.17	-3.74	-3.33	-2.95	-2.61	-2.31	-2.08	-1.87	-1.73	-1.62	-1.56
Efficiency (%)	29.29	31.93	34.91	38.31	42.22	46.45	50.71	54.87	58.73	61.95	65.04	67.18	68.94	69.78
Gain (dBi)	-2.75	-2.35	-2	-1.62	-1.2	-0.77	-0.4	-0.07	0.21	0.43	0.63	0.77	0.87	0.92

Frequency(MHz)	916	917	918	919	920	921	922	923	924	925	926	927	928
Efficiency (dB)	-1.59	-1.68	-1.84	-2.06	-2.31	-2.58	-2.86	-3.16	-3.48	-3.82	-4.19	-4.56	-4.92
Efficiency (%)	69.33	67.94	65.48	62.29	58.73	55.18	51.79	48.33	44.85	41.5	38.08	34.98	32.21
Gain (dBi)	0.88	0.79	0.62	0.4	0.12	-0.16	-0.46	-0.75	-1.11	-1.46	-1.84	-2.24	-2.57

### 7-3. 3D Efficiency vs. Frequency

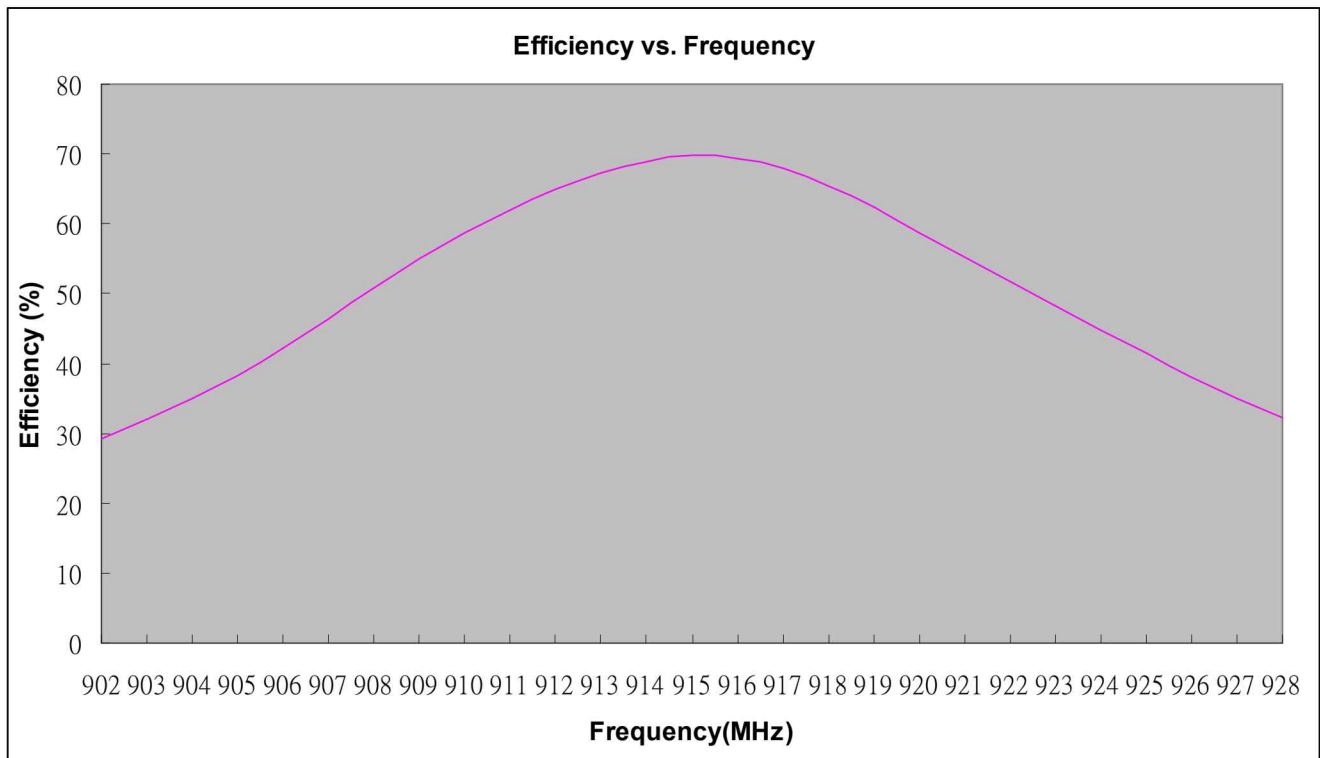

 <p>詠業科技股份有限公司 Unictron Technologies Corporation Website: www.unictron.com</p>	<p>THIS DRAWINGS AND SPECIFICATIONS ARE THE PROPERTY OF UNICTRON TECHNOLOGIES CORPORATION AND SHALL NOT BE REPRODUCED OR USED AS THE BASIS FOR THE MANUFACTURE OR SALE OF APPARATUS OR DEVICES WITHOUT PERMISSION</p>		
	<p>4023/273 Document Control Center</p>		
Prepared by : Betty	Designed by : Sam	Checked by : Mike	Approved by : Herbert
TITLE : 10.0 x 3.2 x 0.5 (mm) ISM Ceramic Chip Antenna (AA066) Engineering Specification	DOCUMENT NO.	H2U646MHLQ0200	REV. K

## 8. Layout Guide:

### a. Solder Land Pattern:

Land pattern for soldering (black marking areas) is as shown below. Matching circuit is needed for good performance, when customer's device is different.

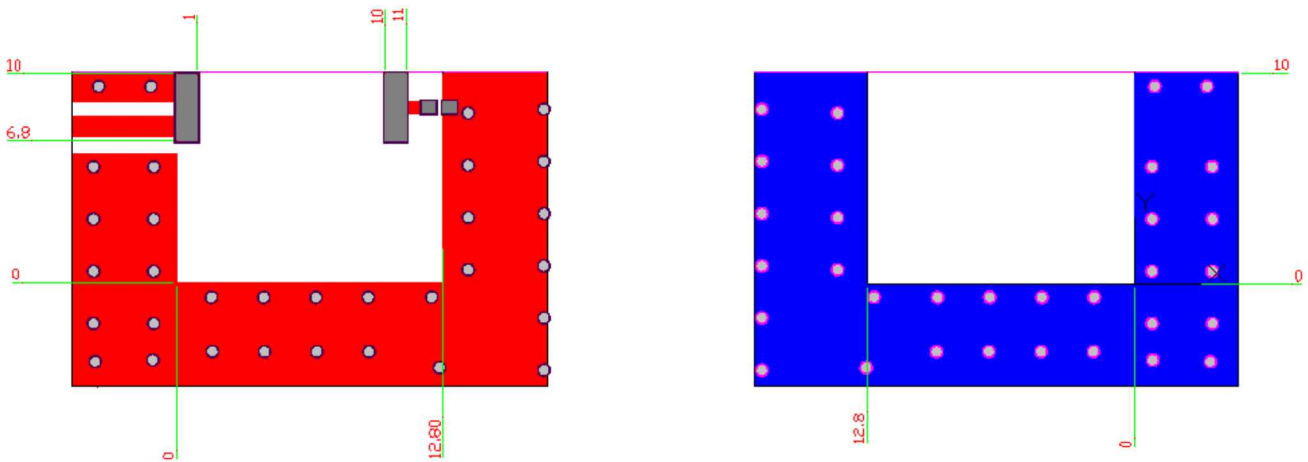

### b. Matching circuit :

(Center frequency is about 915 MHz @ 80 x 40 mm<sup>2</sup> Evaluation Board)

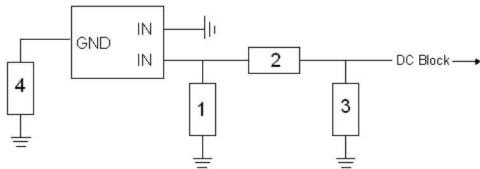

System Matching Circuit Component			
Location	Description	Vendor	Tolerance
1	N/A*	-	-
2	0Ω*	(0402)	-
3	5.0pF*	Murata (0402)	±0.05 pF
4	10pF*	Murata (0402)	±5 %

\*Typical reference values which may need to be changed when circuit boards or part vendors are different.



詠業科技股份有限公司  
Unictron Technologies Corporation  
Website: www.unictron.com

THIS DRAWINGS AND SPECIFICATIONS ARE THE PROPERTY OF UNICTRON TECHNOLOGIES CORPORATION AND SHALL NOT BE REPRODUCED OR USED AS THE BASIS FOR THE MANUFACTURE OR SALE OF APPARATUS OR DEVICES WITHOUT PERMISSION

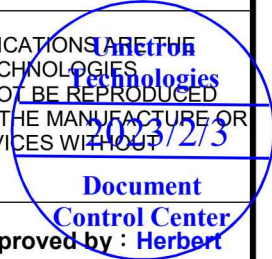

Prepared by : Betty

Designed by : Sam

Checked by : Mike

Approved by : Herbert

TITLE : 10.0 x 3.2 x 0.5 (mm) ISM Ceramic Chip Antenna (AA066) Engineering Specification

DOCUMENT NO.

H2U646MHLQ0200

REV. K

## 9. Soldering Conditions:

### a. Typical Soldering Profile for Lead-free Process

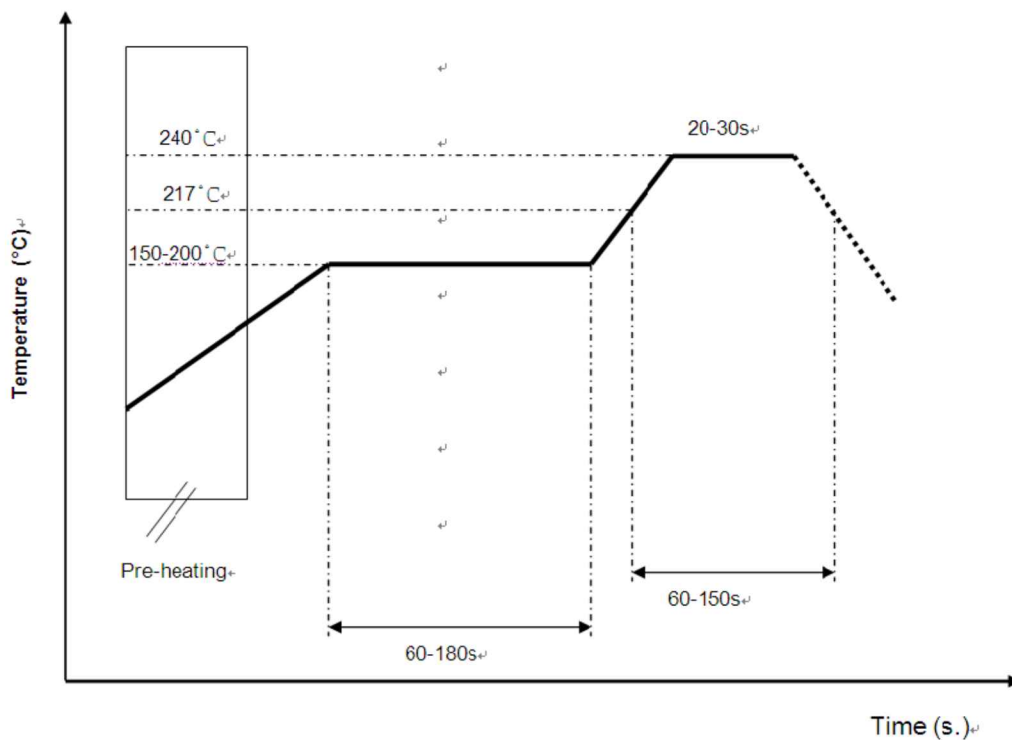

\*Recommended solder paste alloy: SAC305 (Sn96.5 /Ag3 /Cu0.5) Lead Free solder paste.

## 10. Reminders for users of Unictron's chip antennas

- Since Unictron's chip antennas are made of ceramic materials which show different rigidity than circuit board materials, bending of circuit board at the locations where chip antennas are mounted may cause the cracking of solder joints or antenna itself.
- Any connecting strip which will be cut off at PCB assembly process shall be located away from the installation site of chip antenna. Punching of the connecting strip may cause severe bending of the circuit board and cracking of solder joint or chip antenna itself may occur.
- Be cautious when ultrasonic welding process needs to be used near the locations where chip antennas are installed. Strong ultrasonic vibration may cause the cracking of chip antenna solder joints.



詠業科技股份有限公司  
Unictron Technologies Corporation  
Website: www.unictron.com

THIS DRAWINGS AND SPECIFICATIONS ARE THE PROPERTY OF UNICTRON TECHNOLOGIES CORPORATION AND SHALL NOT BE REPRODUCED OR USED AS THE BASIS FOR THE MANUFACTURE OR SALE OF APPARATUS OR DEVICES WITHOUT PERMISSION

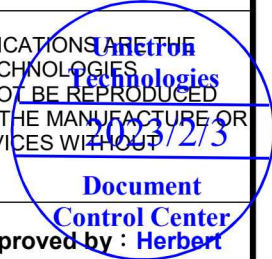

Prepared by : Betty

Designed by : Sam

Checked by : Mike

Approved by : Herbert

TITLE : 10.0 x 3.2 x 0.5 (mm) ISM Ceramic Chip Antenna (AA066) Engineering Specification

DOCUMENT NO.

H2U646MHLQ0200

REV. K



## 11. Packing:

- (1) Quantity/Reel: 6000pcs/Reel
- (2) Plastic tape: Black Conductive Polystyrene

a. Tape Drawing

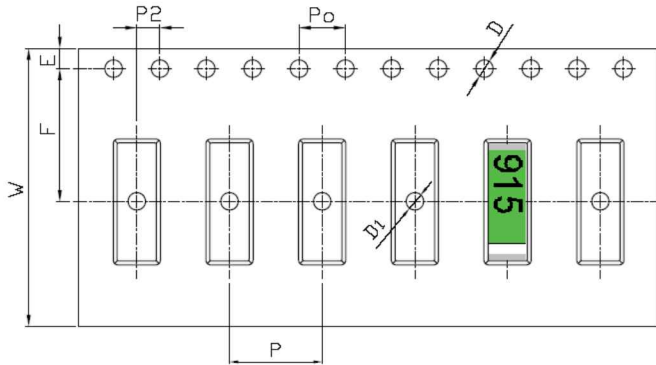

b. Tape Dimensions (unit: mm)

Feature	Specifications	Tolerances
W	24.00	±0.30
P	8.00	±0.10
E	1.75	±0.10
F	11.50	±0.10
P2	2.00	±0.10
D	1.50	+0.10 0.00
D1	1.50	±0.10
Po	4.00	±0.10
10Po	40.00	±0.20

## 12. Operating & Storage Conditions

### 12-1. Operating

- (1) Maximum Input Power: 2 W
- (2) Operating Temperature: -40°C to 85°C
- (3) Relative Humidity: 10% to 70%

### 12-2. Storage (sealed)

- (1) Storage Temperature: -5°C to 40°C
- (2) Relative Humidity: 20% to 70%
- (3) Shelf Life: 1 year

### 12-3. Storage (After mounted on customer's PCB with SMT process)

- (1) Storage Temperature: -40°C to 85°C
- (2) Relative Humidity: 10% to 70%

## 13. Notice

- (1) Installation Guide:

Please refer to Unictron's application note "General guidelines for the installation of Unictron's chip antennas" for further information.

- (2) All specifications are subject to change without notice.



詠業科技股份有限公司  
Unictron Technologies Corporation  
Website: www.unictron.com

THIS DRAWINGS AND SPECIFICATIONS ARE THE PROPERTY OF UNICTRON TECHNOLOGIES CORPORATION AND SHALL NOT BE REPRODUCED OR USED AS THE BASIS FOR THE MANUFACTURE OR SALE OF APPARATUS OR DEVICES WITHOUT PERMISSION

Prepared by : Betty

Designed by : Sam

Checked by : Mike

Approved by : Herbert

TITLE : 10.0 x 3.2 x 0.5 (mm) ISM Ceramic Chip Antenna (AA066) Engineering Specification

DOCUMENT NO.

H2U646MHLQ0200

REV. K