



SPECIFICATION SHEET

| | | |
|---|--|--|
| SPECIFICATION SHEET NO. | Q1208- BDBNCAV9WSFBS3 | |
| DATE | Dec. 08, 2023 | |
| REVISION | A0 | Updated With Most Recent Data - Official First Release |
| DESCRIPTION AND MAIN PARAMETRICS | <p>Automotive PLCC-2 TOP LED SMD 3528 L3.50*W2.80*H1.85mm Colorless and Clear Lens Transparency, 2.4mm Dia Lens Round with Flat Top Color Cyan 0.1W, Forward Voltage (V9) 3.2~3.4V Dominant Wavelength Rank (WS) 500~505nm Luminous Intensity Rank (FB) 1460~1890mcd Operating Temp. Range -40°C ~+105°C Package in Tape/Reel, REACH/RoHS/RoHS III Compliant</p> | |
| CUSTOMER | | |
| CUSTOMER PART NO. | | |
| CROSS REF. PART NO. | | |
| ORIGINAL MFG/PART NO. | BNDLight/BDB-NCA-V9WSFB | |
| PART CODE | BDBNCAV9WSFBS3 | |

| | | | |
|-------------------------|---|--|---|
| VENDOR APPROVE | | | |
| Issued/Checked/Approved |  |  |  |
| DATE: Dec. 08, 2023 | | | |

| | |
|-------------------------|--|
| CUSTOMER APPROVE | |
| | |
| DATE: | |

AUTOMOTIVE SMD TOP LED PLCC-2 3528 BDB-NCA SERIES

MAIN FEATURE

- Cyan Color PLCC-2 Package
- Emitting Material: InGaAlP Chip
- Low Light Attenuation and High Brightness
- Luminous Intensity@20mA: 910~2290mcd
- View Angle at 50% Iv of 120°
- 100% Pure Gold Wire
- Excellent Stability and Thermostability
- Corrosion Robustness: Excellent Corrosion Robustness
- Suitable for SMT process
- Cross Competitors Parts
- REACH/RoHS/RoHS III Compliant



APPLICATION

- Auto Signaling
- Auto Lighting Interior and Exterior
- Signal and Symbol Luminary

RFQ
Request For Quotation

PART CODE GUIDE

| BDB | NCA | V9 | WS | FB | S3 |
|-----|-----|----|----|----|----|
| 1 | 2 | 3 | 4 | 5 | 6 |

1. BDB: PLCC-2 Package TOP LED SMD 3528 Dimension L3.50*W2.80*H1.85mm
2. NCA: 0.1W Color Cyan
3. V9: Bin Code, Forward Voltage: 3.2~3.4V, see Page 5
4. WS: Bin Code Dominant Wavelength Rank: 500~505nm, see Page 5
5. FB: Bin Code, Luminous Intensity Rank: 1460~1890mcd, see Page 5
6. S3: Internal Control Code or special Parameters code letter A~Z or digits (1-9)

ELECTRICAL CHARACTERISTICS

See Page 6 ~Page 7 For Different Part Code

HOW TO ORDER

Please follow up Part Code Guide and indicate pat code when you order or RFQ.

AUTOMOTIVE SMD TOP LED PLCC-2 3528 BDB-NCA SERIES

DIMENSION – (Unit: mm, Tol.: +/-0.1mm)

Image For Reference

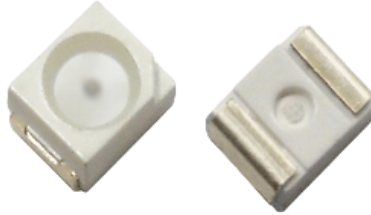

BDB Series

Size Code 3528

Dimension

L3.50*W2.80*H1.85mm

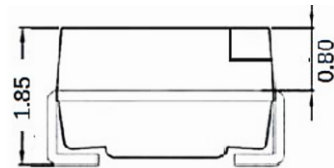
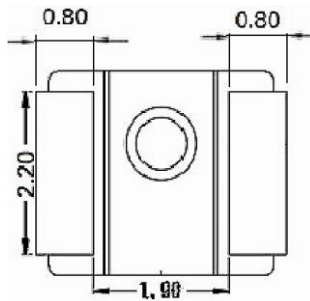
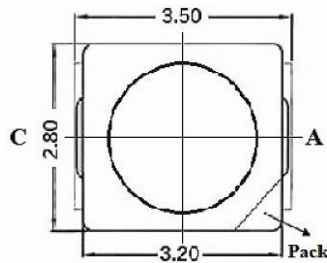

Recommend

Pad Layout

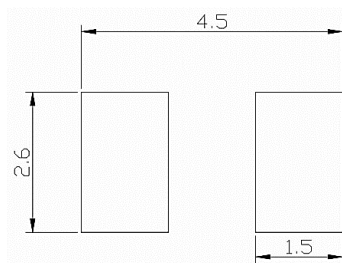

AUTOMOTIVE SMD TOP LED PLCC-2 3528 BDB-NCA SERIES
MAXIMUM RATINGS $T_s=25^{\circ}\text{C}$, RH60%

| Parameters | Symbol | Values | Unit |
|--|--------|----------|--------------------|
| Operating Temperature | Top | -40~+105 | $^{\circ}\text{C}$ |
| Storage Temperature | Tstg | -40~+105 | $^{\circ}\text{C}$ |
| Junction Temperature | Tj | 110 | $^{\circ}\text{C}$ |
| Forward Current ($T_s=25^{\circ}\text{C}$) | IF | 30 | mA |
| Surge Current ($t \leq 10\mu\text{s}$; $D=0.005$; $T_s=25^{\circ}\text{C}$) | IFS | 100 | mA |
| Reverse Voltage ($T_s=25^{\circ}\text{C}$) | VR | 5 | V |
| Electrostatic Discharge (acc.to ANSI/ESDA/JEDEC JS-001-2017) | VESD | ≥ 2 | kV |

OPTICAL & ELECTRICAL CHARACTERISTICS $I_f=20\text{mA}$, $T_s=25^{\circ}\text{C}$, RH60%

| Parameters | Symbol | Values | | | Unit |
|---|---------------------------|--------|------|------|---------------|
| | | Min. | Typ. | Max. | |
| Peak Wavelength | λ_{peak} | - | 503 | - | nm |
| Dominant wavelength | λ_{dom} | 495 | - | 510 | nm |
| Spectral bandwidth at 50% IV | $\Delta\lambda$ | - | 26 | - | nm |
| Viewing Angle | $2\theta_{1/2}$ | - | 120 | - | Deg |
| Forward Voltage | V_F | 2.8 | 3.0 | 3.4 | V |
| Reverse Current | I_R ($V_R=5\text{V}$) | - | 0.2 | 10 | μA |
| Thermal Resistance junction/solder point | $R_{\text{th(j-sp)real}}$ | - | 111 | 134 | K/W |
| Electrical Thermal Resistance junction/solder point with efficiency $\eta=31\%$ | $R_{\text{th(j-sp)elec}}$ | - | 73 | 88 | K/W |

AUTOMOTIVE SMD TOP LED PLCC-2 3528 BDB-NCA SERIES
BIN CODE LIST

| Parameters | Symbol | Values | Tolerance | Unit |
|--|--------|-----------|-----------|------|
| Forward Voltage Rank (VF) @IF=20mA, Ts=25°C, RH60% | V7 | 2.8~3.0 | ±0.05 | V |
| | V8 | 3.0~3.2 | | |
| | V9 | 3.2~3.4 | | |
| | | | | |
| Dominant Wavelength Rank (DWL) @IF=20mA, Ts=25°C, RH60% | WR | 495~500 | ±1.0 | nm |
| | WS | 500~505 | | |
| | WT | 505~510 | | |
| Luminous Intensity Rank (IV) @IF=20mA, Ts=25°C, RH60% | Fd | 910~1170 | ±5.0% | mcd |
| | FA | 1170~1460 | | |
| | FB | 1460~1890 | | |
| | FC | 1890~2290 | | |
| | | | | |

AUTOMOTIVE SMD TOP LED PLCC-2 3528 BDB-NCA SERIES
ELECTRICAL CHARACTERISTICS IF=20mA, Ts=25°C, RH60%, Tol. :±0.05V

| Part Code | Forward Voltage - VF (V) | Dominant Wavelength- DWL (nm) | Luminous Intensity- IV (mcd) |
|----------------|-----------------------------|----------------------------------|---------------------------------|
| BDBNCAV7WRFdS1 | 2.8~3.0 | 495~500 | 910~1170 |
| BDBNCAV7WRFAS2 | 2.8~3.0 | 495~500 | 1170~1460 |
| BDBNCAV7WRFBS3 | 2.8~3.0 | 495~500 | 1460~1890 |
| BDBNCAV7WRFCS4 | 2.8~3.0 | 495~500 | 1890~2290 |
| BDBNCAV8WRFdS1 | 3.0~3.2 | 495~500 | 910~1170 |
| BDBNCAV8WRFAS2 | 3.0~3.2 | 495~500 | 1170~1460 |
| BDBNCAV8WRFBS3 | 3.0~3.2 | 495~500 | 1460~1890 |
| BDBNCAV8WRFCS4 | 3.0~3.2 | 495~500 | 1890~2290 |
| BDBNCAV9WRFdS1 | 3.2~3.4 | 495~500 | 910~1170 |
| BDBNCAV9WRFAS2 | 3.2~3.4 | 495~500 | 1170~1460 |
| BDBNCAV9WRFBS3 | 3.2~3.4 | 495~500 | 1460~1890 |
| BDBNCAV9WRFCS4 | 3.2~3.4 | 495~500 | 1890~2290 |
| BDBNCAV7WSFdS1 | 2.8~3.0 | 500~505 | 910~1170 |
| BDBNCAV7WSFAS2 | 2.8~3.0 | 500~505 | 1170~1460 |
| BDBNCAV7WSFBS3 | 2.8~3.0 | 500~505 | 1460~1890 |
| BDBNCAV7WSFCS4 | 2.8~3.0 | 500~505 | 1890~2290 |
| BDBNCAV8WSFdS1 | 3.0~3.2 | 500~505 | 910~1170 |
| BDBNCAV8WSFAS2 | 3.0~3.2 | 500~505 | 1170~1460 |
| BDBNCAV8WSFBS3 | 3.0~3.2 | 500~505 | 1460~1890 |
| BDBNCAV8WSFCS4 | 3.0~3.2 | 500~505 | 1890~2290 |

AUTOMOTIVE SMD TOP LED PLCC-2 3528 BDB-NCA SERIES
ELECTRICAL CHARACTERISTICS IF=20mA, Ts=25°C, RH60%, Tol. :±0.05V

| Part Code | Forward Voltage - VF (V) | Dominant Wavelength- DWL (nm) | Luminous Intensity- IV (mcd) |
|-----------------------|-----------------------------|----------------------------------|---------------------------------|
| BDBNCAV9WSFdS1 | 3.2~3.4 | 500~505 | 910~1170 |
| BDBNCAV9WSFAS2 | 3.2~3.4 | 500~505 | 1170~1460 |
| BDBNCAV9WSFBS3 | 3.2~3.4 | 500~505 | 1460~1890 |
| BDBNCAV9WSFCS4 | 3.2~3.4 | 500~505 | 1890~2290 |
| BDBNCAV7WTFdS1 | 2.8~3.0 | 505~510 | 910~1170 |
| BDBNCAV7WTFAS2 | 2.8~3.0 | 505~510 | 1170~1460 |
| BDBNCAV7WTFBS3 | 2.8~3.0 | 505~510 | 1460~1890 |
| BDBNCAV7WTFCS4 | 2.8~3.0 | 505~510 | 1890~2290 |
| BDBNCAV8WTFdS1 | 3.0~3.2 | 505~510 | 910~1170 |
| BDBNCAV8WTFAS2 | 3.0~3.2 | 505~510 | 1170~1460 |
| BDBNCAV8WTFBS3 | 3.0~3.2 | 505~510 | 1460~1890 |
| BDBNCAV8WTFCS4 | 3.0~3.2 | 505~510 | 1890~2290 |
| BDBNCAV9WTFdS1 | 3.2~3.4 | 505~510 | 910~1170 |
| BDBNCAV9WTFAS2 | 3.2~3.4 | 505~510 | 1170~1460 |
| BDBNCAV9WTFBS3 | 3.2~3.4 | 505~510 | 1460~1890 |
| BDBNCAV9WTFCS4 | 3.2~3.4 | 505~510 | 1890~2290 |

AUTOMOTIVE SMD TOP LED PLCC-2 3528 BDB-NCA SERIES

REFLOW SOLDERING CHARACTERISTICS

Product complies to MSL Level 2a acc. To JEDEC J-STD-020 D.01

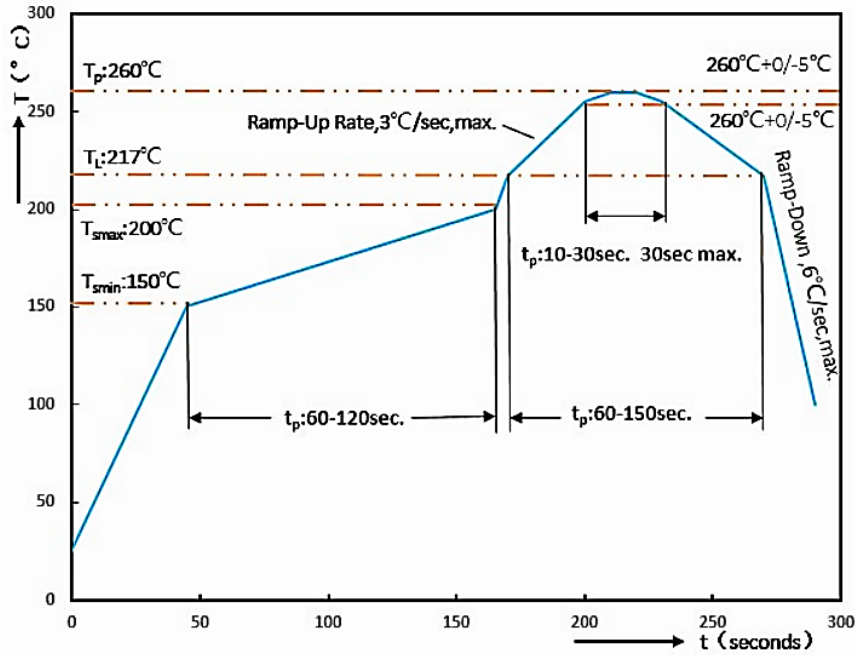

| | | |
|---|---------------------------|-------------------|
| Profile Feature | | Pb-Free Assembly |
| Average Ramp-up Rate (Ts Max to Tp) | | 3°C/second Max |
| Preheat | Temperature Min (Ts Min.) | 150°C |
| | Temperature Max (Ts Max.) | 200°C |
| | Time (ts Min. to ts Max.) | 60 ~ 120 seconds |
| Time maintained above | Temperature (Tl) | 217°C |
| | Time (tl) | 60 ~ 150 seconds |
| Peak/Classification Temperature (Tp) | | 260 °C |
| Time within 5°C of actual Peak Temperature (tp) | | 30 seconds Max |
| Ramp-down rate | | 6 °C /Second Max. |
| Time 25 °C to Peak Temperature | | 8 minutes Max. |
| Suggest reflow times | | 3 Times Max. |

AUTOMOTIVE SMD TOP LED PLCC-2 3528 BDB-NCA SERIES

OPTICAL & ELECTRICAL CHARACTERISTICS CURVES -IF=20mA, Ts=25°C, RH60%

Figure 1. Relative Intensity vs. Wavelength

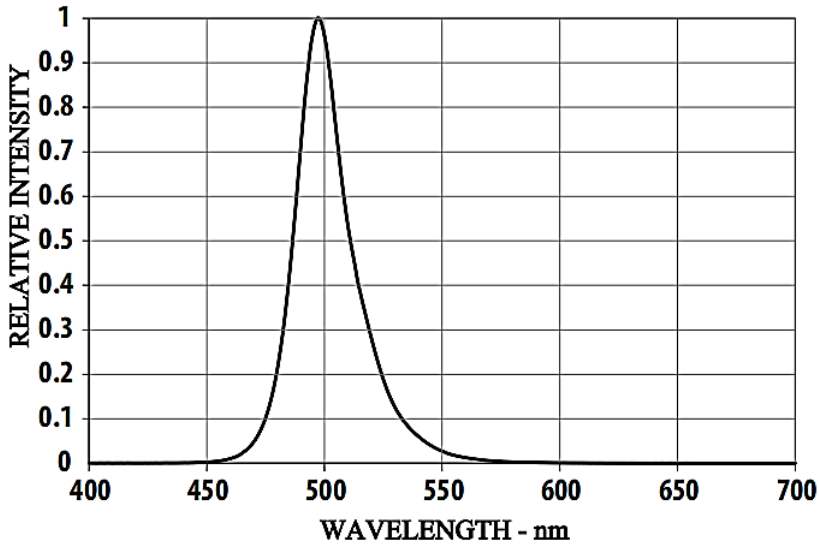
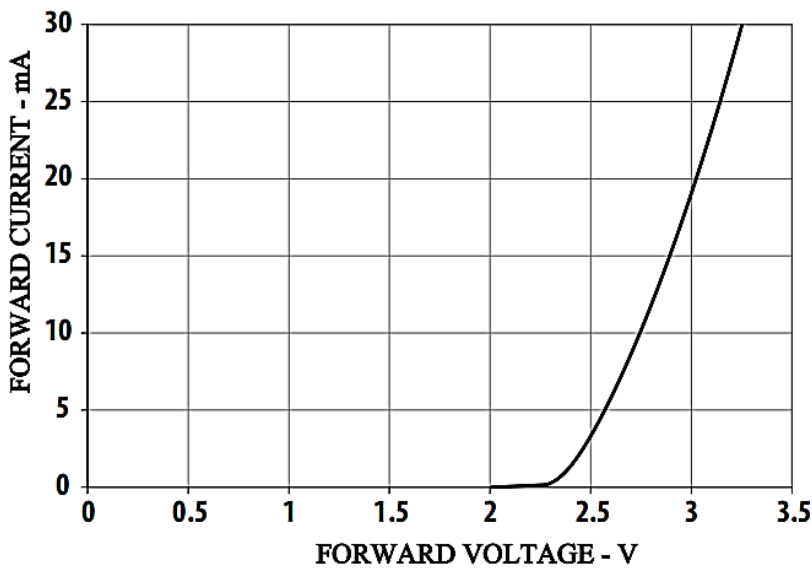

Figure 2. Forward Current vs. Forward Voltage



AUTOMOTIVE SMD TOP LED PLCC-2 3528 BDB-NCA SERIES

OPTICAL & ELECTRICAL CHARACTERISTICS CURVES -IF=20mA, Ts=25°C, RH60%

Figure 3. Relative Intensity vs. Forward Current

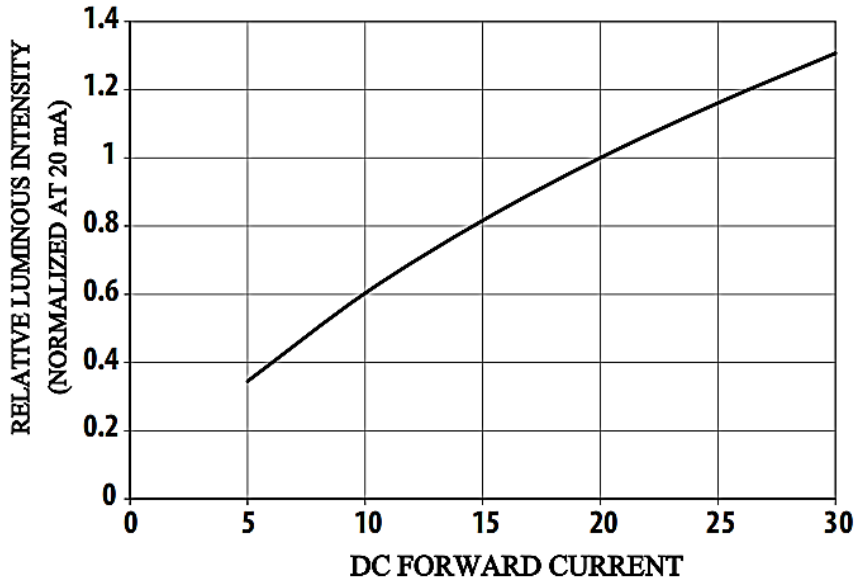
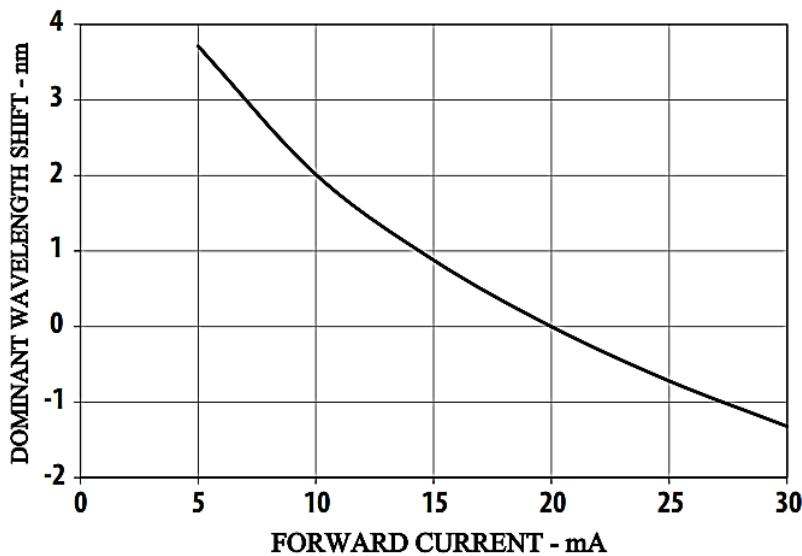

Figure 4. Relative Dominant Wavelength vs. Forward Current



AUTOMOTIVE SMD TOP LED PLCC-2 3528 BDB-NCA SERIES

OPTICAL & ELECTRICAL CHARACTERISTICS CURVES -IF=20mA, Ts=25°C, RH60%

Figure 5. Maximum Forward Current vs. Ambient Temperature

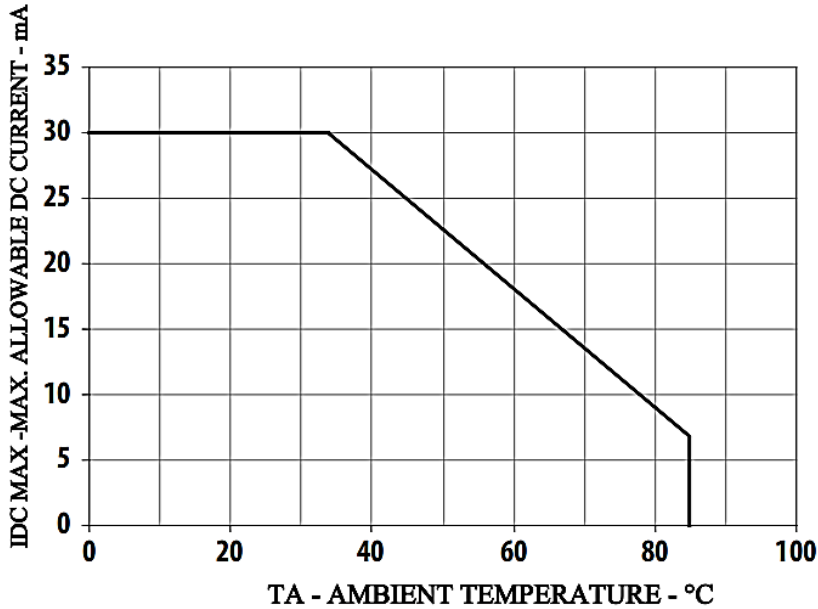
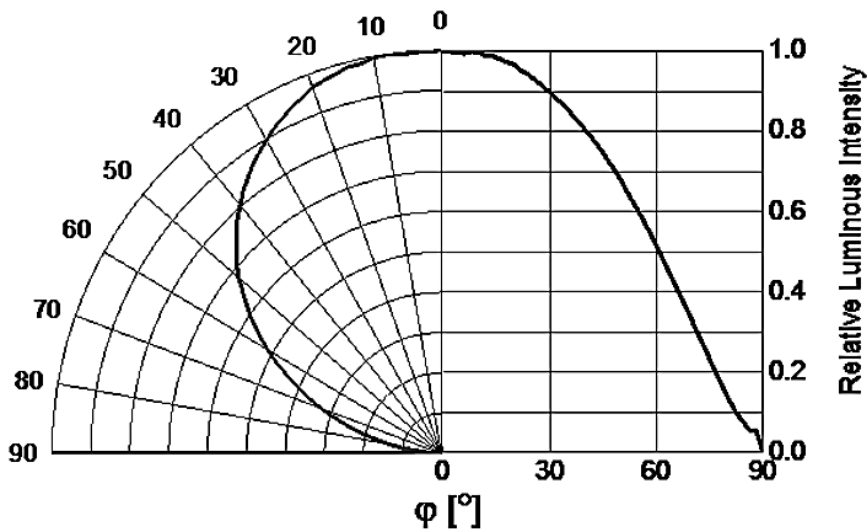

Figure 6. Representative Spatial Radiation Pattern 120°Lamps



AUTOMOTIVE SMD TOP LED PLCC-2 3528 BDB-NCA SERIES

OPTICAL & ELECTRICAL CHARACTERISTICS CURVES -IF=20mA, Ts=25°C, RH60%

Figure 7. Relative Light Output vs. Junction Temperature

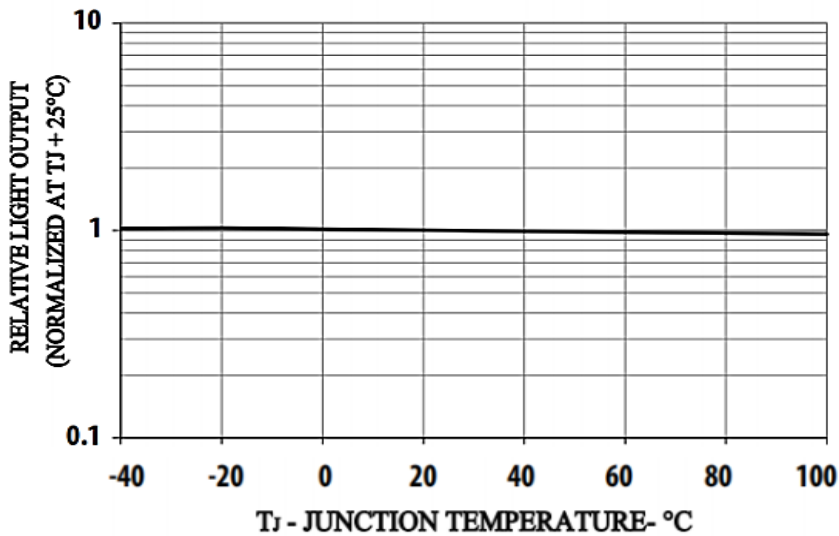
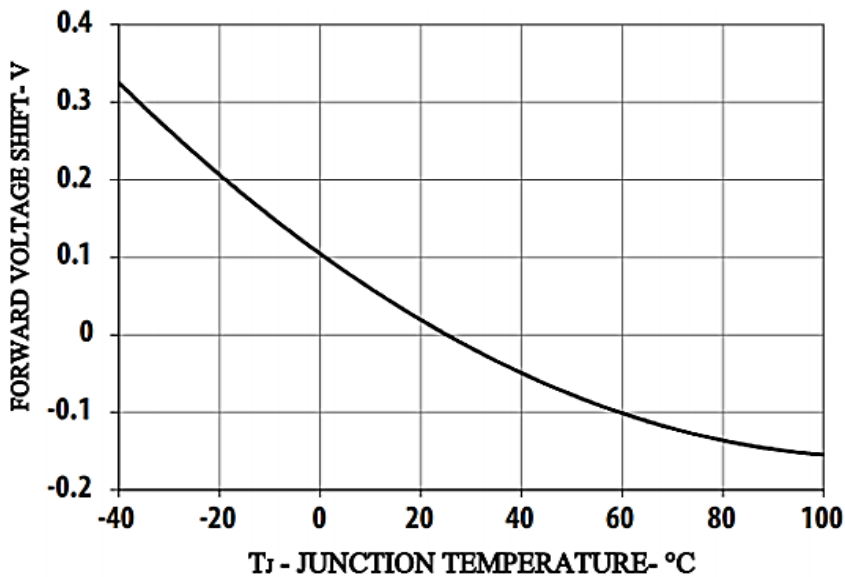

Figure 8. Forward Voltage Shift vs. Junction Temperature



AUTOMOTIVE SMD TOP LED PLCC-2 3528 BDB-NCA SERIES

TAPE/REEL, 2000pcs/Reel (Unit: mm)

- All Devices are packed in accordance with EIA standard RS-481-A
- Cumulative Tolerance : Cumulative Tolerance/10 pitches to be $\pm 0.2\text{mm}$
- Adhesion Strength of Cover Tape Adhesion strength to be 0.1-0.7N when the cover tape is turned off from the carrier tape at the angle of 10° to the carrier tape.
- Moisture Resistant Package

Tape

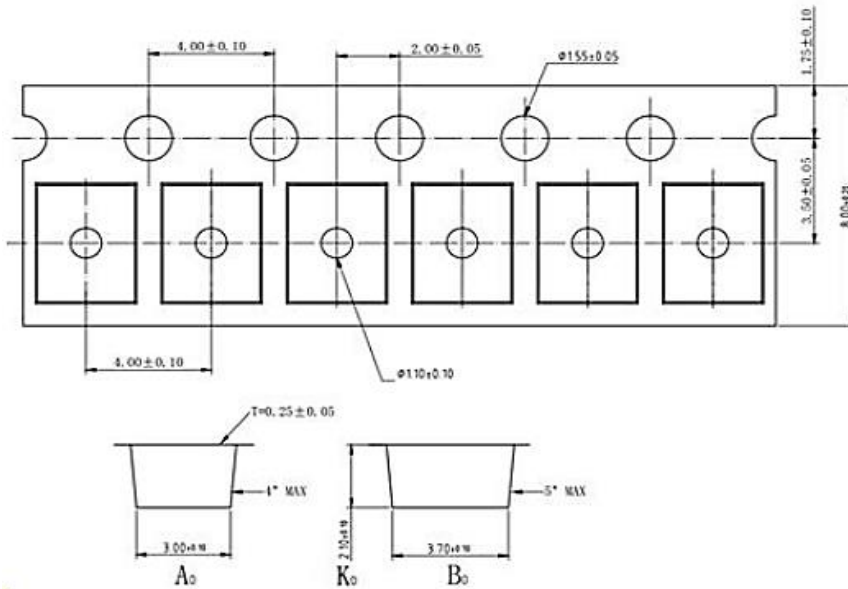

Reel

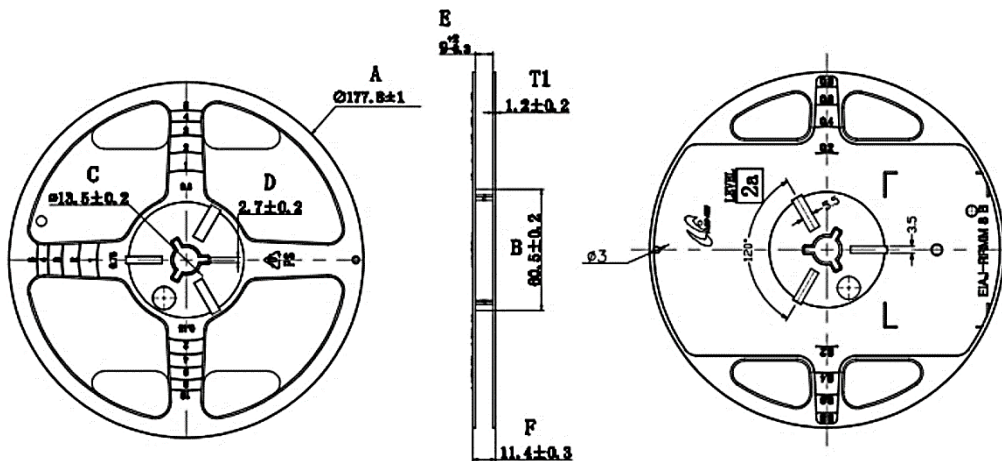

AUTOMOTIVE SMD TOP LED PLCC-2 3528 BDB-NCA SERIES

APPLICATION NOTES - Part I

- Storage: To avoid the moisture penetration, we recommend store in a dry box with a desiccant, The maximum storage temperature range is 40°C and a maximum humidity of RH60%.
- Use Precaution after Opening the Packaging: Recommend conditions after opening the package
 - a) Sealing b) Temperature : 30°C Humidity: Less than RH50% c) Recommend to use up before 72hrs after opening the package.
- If the package has been opened more than 4 weeks(MSL_2a) or the color desiccant changes, LED Components should be dried for 12hrs at 60±5°C. .
- Do not apply mechanical force or excess vibration during the cooling process to normal temperature after soldering.
- Do not rapidly cool device after soldering.
- The LED should not be mounted on warped portion of PCB.
- The LED should not be used in any type of fluid such as water, oil, organic solvent and etc. When washing is required, IPA (Isopropyl Alcohol) should be used.
- When the LEDs are in operation the maximum current should be decided after measuring the package temperature.
- Long time exposure of sunlight or occasional UV exposure will cause lens discoloration.
- The driving circuit must be designed to allow forward voltage only when it is ON or OFF. If the reverse voltage is applied to LED, migration can be generated resulting in LED damage.
- LEDs are sensitive to Electro-Static Discharge (ESD). Below is a list of suggestions that BND purposes to minimize these effects.
- The products are sensitive to static electricity or surge voltage. ESD can damage a die and it's Reliability. When handing the products, the following measures against electrostatic discharge are strongly recommended:
 - a) Increase in reverse leakage current lowered turn-on voltage
 - b) Abnormal emissions from the LED at low current LED

AUTOMOTIVE SMD TOP LED PLCC-2 3528 BDB-NCA SERIES

APPLICATION NOTES - Part II

The following recommendations are suggested to help minimize the potential for an ESD event.

- One or more recommended work area suggestions:
 - a) Dissipating static charge with conductive materials
 - b) Preventing charge generation with moisture
 - c) ESD safe storage containers ESD
- One or more personnel suggestion options:
 - a) Antistatic wrist-strap
 - b) Antistatic material shoes
 - c) Antistatic clothes
- Environmental controls: Humidity control (ESD gets worse in a dry environment)
- Handling Precautions: During processing, mechanical stress on the surface should be minimized as much as possible. Sharp objects of all types should not be used to pierce the sealing compound. In general, LEDs should only be handled from the side. By the way, this also applies to LEDs Without a silicone sealant, since the surface can also become scratched.
- NextGen suggests using isopropyl alcohol for cleaning. In case other solvents are used, it must be assured that these solvents do not dissolve the package or resin. Please do not mold this products into another resin (epoxy, urethane, etc.) and do not handle this Product with acid or sulfur material in sealed space.

AUTOMOTIVE SMD TOP LED PLCC-2 3528 BDB-NCA SERIES

APPLICATION NOTES - Part III

- The evaluation of eye safety occurs according to the standard IEC 62471:2006 (photo biological safety of lamps and lamp systems). Within the risk grouping system of this IEC standard, the device specified in this data sheet falls into the class exempt group (exposure time 10000 s). Under real circumstances (for exposure time, conditions of the eye pupils, observation distance), it is assumed that no endangerment to the eye exists from these devices. As a matter of principle, however, it should be mentioned that intense light sources have a high secondary exposure potential due to their blinding effect. When looking at bright light sources (e.g. headlights), temporary reduction in visual acuity and afterimages can occur, leading to irritation, annoyance, visual impairment, and even accidents, depending on the situation.
- Subcomponents of this device contain, in addition to other substances, metal filed materials including silver. Metal filed materials can be affected by environments that contain traces of aggressive substances. Therefore, we recommend that customers minimize device exposure to aggressive substances during storage, production, and use. Devices that showed visible discoloration when tested using the described tests above did show no performance deviations within failure limits during the stated test duration. Respective failure limits Notes are described in the IEC60810.

AUTOMOTIVE SMD TOP LED PLCC-2 3528 BDB-NCA SERIES

GLOSSARY

- **Brightness:** Brightness values are measured during a current pulse of typically 20ms, with an internal reproducibility of $\pm 5\%$.
- **Wavelength:** The wavelength is measured at a current pulse of typically 20ms, with an internal reproducibility of ± 1.5 nm.
- **Forward Voltage:** The forward voltage is measured during a current pulse of typically 20ms, with an internal reproducibility of ± 0.05 V.
- **Reverse Operation:** Continuous reverse operation is not allowed
- **Thermal Resistance:** RthJA results from mounting on PC board.
- **Typical Values:** Due to the special conditions of the manufacturing processes of semiconductor devices, the typical data or calculated correlations of technical parameters can only reflect statistical figures. These do not necessarily correspond to the actual parameters of each single product, which could differ from the typical data and calculated correlations or the typical characteristic line. If requested, e.g. because of technical improvements, these typ. data will be changed without any further notice.
- **Characteristic curve:** In the range where the line of the graph is broken, you must expect higher differences between single devices within one packing unit.

ROHS COMPLIANCE

- The levels of RoHS restricted materials in this product are below the maximum concentration values (also referred to as the threshold limits) permitted for such substances, or are used in an exempted application, in accordance with EU RoHS Directive (EU) 2015/863 EC (RoHS3). RoHS Test Report for this product can be obtained can be obtained at Download Center.

REACH COMPLIANCE

- REACH substances of high concern (SVHCs) information is available for this product. Since the European Chemical Agency (ECHA) has published notice of their intent to frequently revise the SVHC listing for the foreseeable future, REACH Test Report for this product can be obtained can be obtained at Download Center.

AUTOMOTIVE SMD TOP LED PLCC-2 3528 BDB-NCA SERIES

IMPORTANT NOTES AND DISCLAIMER

- All Product parametric performance is indicated in the Electrical Characteristics for the listed herein test conditions, unless otherwise noted. Product performance may not be indicated by the Electrical Characteristics if operated under different conditions.
- NextGen Component, Inc (*NextGen*) reserves the right to make changes to this document and its products and specifications at any time without notice. Customers should obtain and confirm the latest product information and specifications before final design, purchase or use.
- *NextGen* makes no warranty, representation or guarantee regarding the suitability of its products for any particular purpose, nor does NextGen assume any liability for application assistance or customer product design.
- *NextGen* does not warrant or accept any liability with products which are purchased or used for any unintended or unauthorized application. No license is granted by implication or otherwise under any intellectual property rights of NextGen.
- *NextGen* products are not authorized for use as critical components in life support devices or systems without express written approval by *NextGen*.
- *NextGen* requires that customers first obtain an RMA (Returned Merchandise Authorization) number prior to returning any products. Returns must be made within 30 days of the date of invoice, be in the original packaging, unused and like-new condition. At the time of quoting or purchasing, a product may say that it is Non-Cancelable/ Non-Returnable (NCNR). These products are not returnable and not refundable.