

MOT-BL-DRV-300

Brushless dc motor driver



Brief introduction

MOT-BL-DRV-300 is mainly for BLDC motors of 48v less 440w or 24V less 300w.

1.1 Features

- Acc/Dec time setting
- Pole-pairs selection
- Open/closed loop control
- Max output current P-sv setting
- Restart
- Alarm indication
- Built-in RV speed setting
- External potentiometer speed setting
- External analog signal speed setting
- PWM speed setting

2 Electrical properties and environmental indicators

2.1 Electrical properties

Driver parameter	Min Value	Typical Value	Max Value
Voltage input DC (V)	12	48	56
Current output(A)	-	-	15
Motor speed range(rpm)	-	-	20000
Hall signal voltage(V)	-	-	5
Hall drive current (mA)	12	-	-
External potentiometer(K Ω)	-	10	-

2.2 Environmental indicators

Heat Sinking Method	Natural cooling or fan-forced cooling
Atmosphere	Avoid dust, oily mist and corrosive air
Operating Temperature	0 ~ +40°C
Ambient Humidity	90% or less (non-condensing)
Vibration Resistance	5.7m/s ² maximum
Storage Temperature	0 ~ +50t

3 Dimension(Unit: mm)

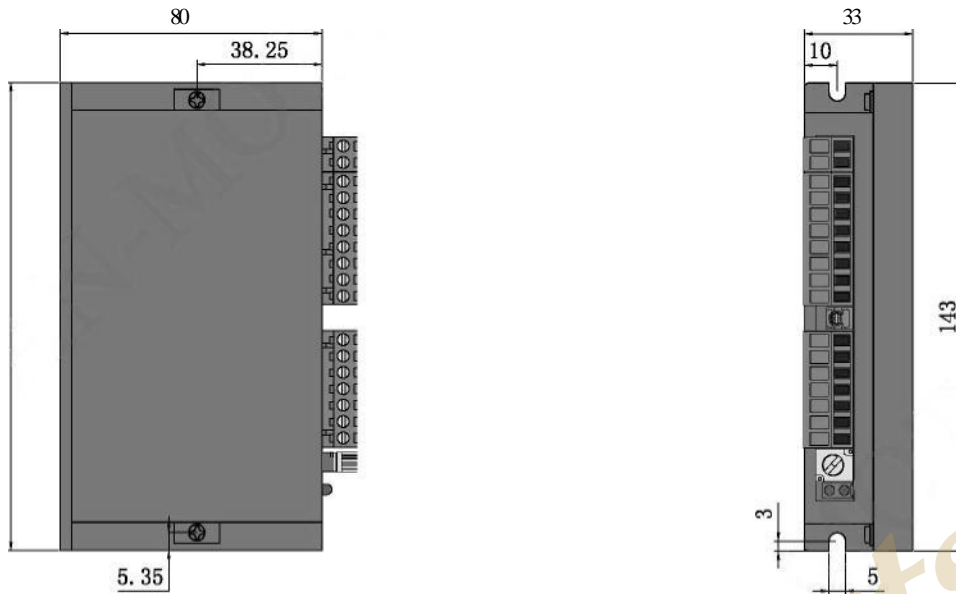

4 Driver interface and wiring diagram

4.1 Driver interface

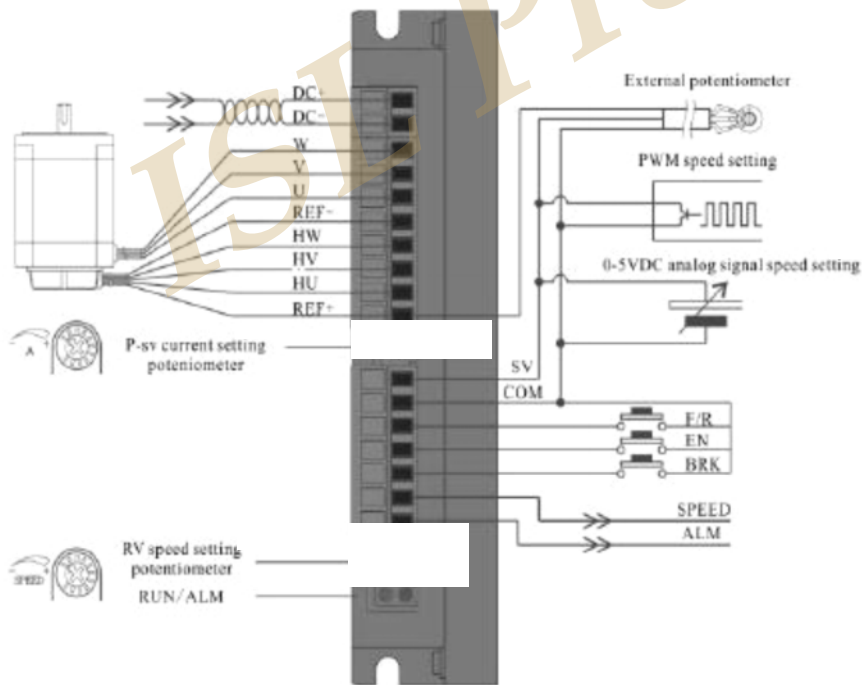

4.2 Port Signal Description

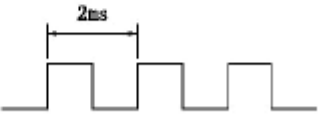
Signal category	Terminal	Functional Description
Power connection	DC+	Power supply positive electrode (12-30VDC)
	DC-	Power supply negative electrode
Motor connection	W	Motor line W phase
	V	Motor line V phase
	U	Motor line U phase
Hall signal	REF-	Hall sensor signal-
	HW	Hall sensor signal Hw
	HV	Hall sensor signal Hv
	HU	Hall sensor signal Hu
	REF+	Hall sensor signal power supply+
Control signal	SV	① External potentiometer speed setting input; ② External analog voltage input terminal ③ PWM speed setting input
	COM	Common port(0V)
	F/R	Motor direction control terminal; F/R and COM disconnect, motor will rotates clockwise, and otherwise, motor will rotate anticlockwise.
	EN	Stop signal terminal;EN connects COM, motor runs, otherwise motor stops.
	BRK	Motor brake stop control signal; BRK and COM connect in default, motor brake stops when BRK and COM disconnect.
Output signal	SPEED	Output pulse frequency corresponded with running speed. Speed can be figured out according: $N(\text{rpm}) = (F/P) \times 60/3$ F: Output pulse frequency P: Motor pole pairs N: Motor speed For example: Motor has 4 pole pairs, $F = 1\text{sec}/2\text{ms} = 500\text{Hz}$ $N(\text{rpm}) = (500/4) \times 60/3 = 2500$ 
	ALM	Motor or driver fault signal output. It is 5v in normal situation and 0V when fault occurs.

4.3 Output signal connection diagram

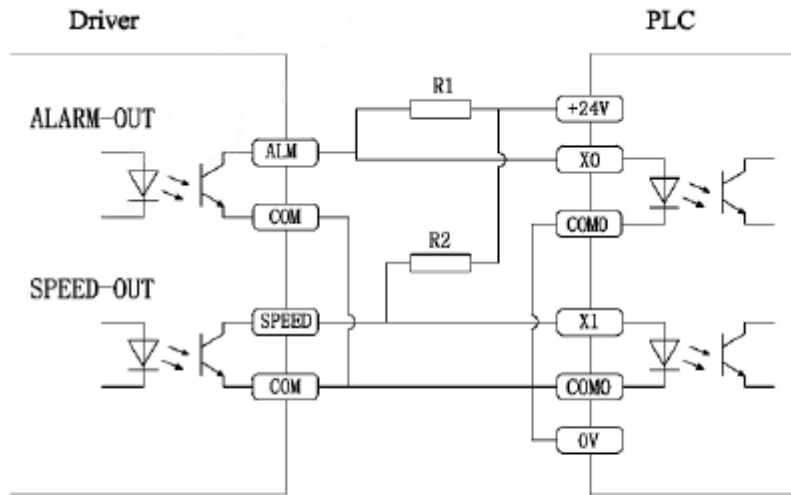

Notice  R1,R2=1KΩ 12V
R1, R2=2KΩ 24V

5 Function setting

5.1 ACC/DEC time setting

Set acceleration time and deceleration time by ACC/DEC, range is 0.3-15s. Acceleration time is time needed from 0 to rated speed. Deceleration time is time needed from rated speed to 0. Ti

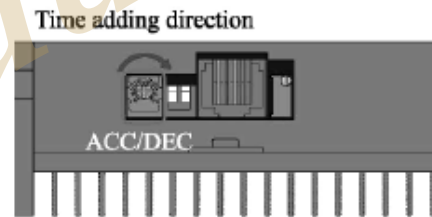

5.2 Motor poles pair selection

SW1 is for motor poles pair selection to match different BLDC motor. ON=2P; OFF=4P

Notice  When closed-loop mode is selected, poles pair should be set rightly.

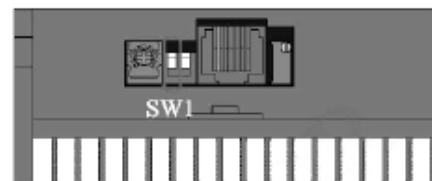

5.3 Open/Closed loop setting

SW2 ON—Closed loop setting; SW2 OFF—Open loop setting

Notice  When closed-loop mode is selected, poles pair should be set rightly.

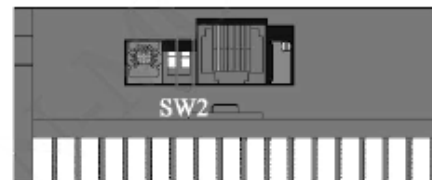

5.4 Peak current setting

Use P-sv to set the output peak current. When load is increased suddenly, the output current will be limited by the setting value, which reduces motor speed and protects the motor. Current setting ranges: 3-15A.

Please set as the right.

As the admissible error of real current and setting value is $\pm 10\%$, to ensure safety, set current lower accordingly.



Notice

The duration of peak current is 3s when load increases suddenly. After 3s, if load is not reduced, driver will stop working. After 5s, it restarts automatically.



P-sv



5.5 Stalling output current limitation

When motor is stalled, the output current is limited to 3A, which protects driver and motor from damage.

5.6 Stalling torque holding

When motor stalls, torque will be kept in short time.



Notice

This feature can't be used for brake stalling.

5.7 Restart function

When stalling occurs, driver stops working, after 5s, it restarts. If fault occurs again, alarm signal will be sent out and driver stop working.

5.8 Motor start and stop

EN and COM terminal is short circuit in default. When power is on, driver will drive motor automatically. If EN disconnects with COM, motor stops.

- ◆ To add a switch or PLC between COM and EN can control the motor start and stop.

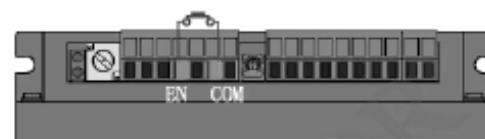

Brake

BRK and COM terminal disconnect in default. Motor will brake stop if BRK and COM are in short circuit.

- ◆ To add a switch or PLC between COM and BRK can control the motor start and stop.



Notice

Difference between EN and BRK

1. EN is for stop naturally, BRK is for stop suddenly.
2. EN and BRK have the same startup state
3. When selecting one of the modes, another mode must be kept as default setting.

5.9 Direction control

F/R and COM disconnect in default, when power is on, motor will start to run clockwise.

Connect F/R and COM, the motor will rotate anticlockwise, otherwise, the motor will rotate clockwise



Notice

The direction is judged from the quarter view of the axle.

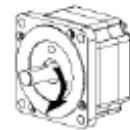
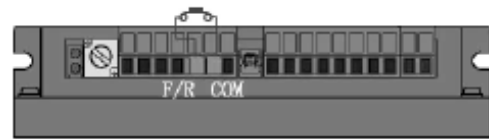

6 Speed setting methods and settings

6.1 Speed setting via built-in potentiometer

Motor speed increases when RV knobs is rotated clockwise, when anticlockwise, motor speed decreases.



Notice

If customers use other speed modes, RV should be rotated anticlockwise to limit position.



Built-in speed potentiometer and motor speed diagram (open-loop no-load)

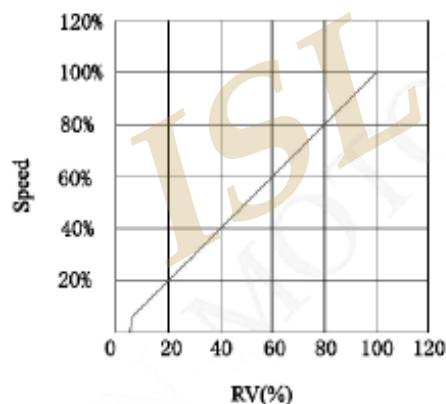

Built-in speed potentiometer and motor speed diagram (closed-loop no-load)

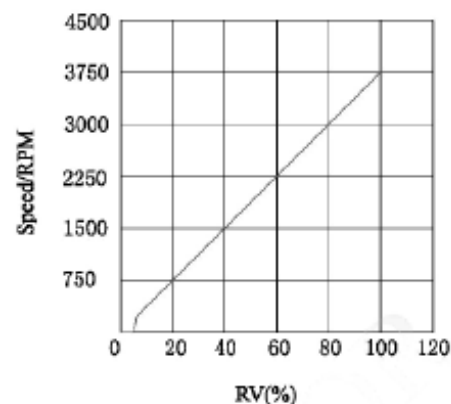

6.2 Speed setting via external potentiometer

Use a suitable potentiometer with a resistance value of 10K Ω ; when connect external potentiometer, the middle terminal connects to SV; the other two terminals connect to REF+ and COM.



Notice

- RV should be rotated anticlockwise to limit position.
- Notice the order of connection of potentiometer.

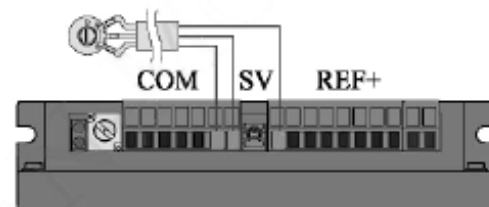

6.3 Speed setting via external analog signal 0-5V



Notice RV should be rotated anticlockwise to limit position.

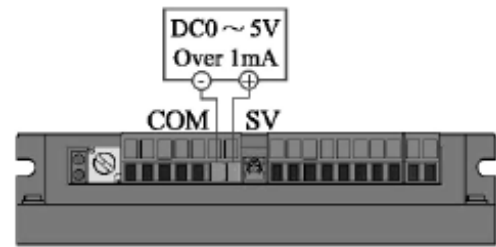

Relational graph between duty ratio and the motor speed (open loop no load)

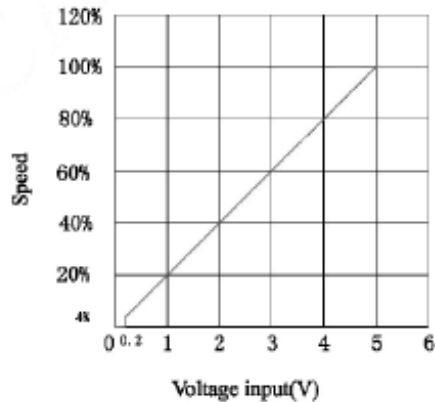

When analog voltage is 0.2V, motor speed is 4% of max speed, when analog voltage is 5V, motor reaches max speed. The max speed also depends on the motor specification and power voltage.

Relational graph between duty ratio and the motor speed (closed loop no load)

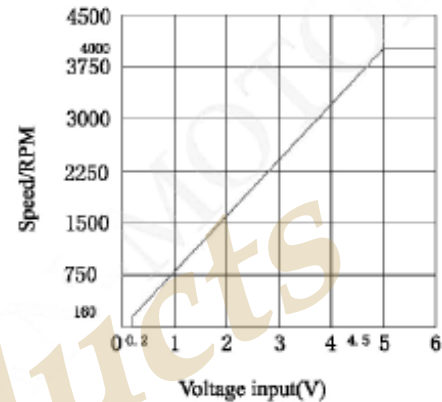

When analog voltage is 0.2V, motor speed is about 160rpm; when analog voltage is 5V, motor reaches max speed 4000rpm.

6.4 PWM Speed setting

 **RV** should be rotated anticlockwise to limit position.
Notice

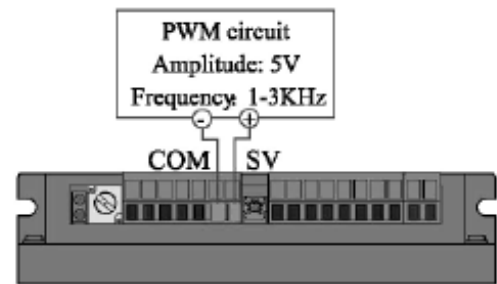

Relational graph between duty ratio and the motor speed (open loop no load)

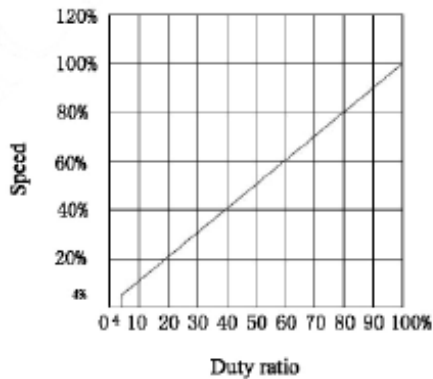

When duty ratio of pulse is 4%, motor speed is 4% of max speed, when duty ratio is 100%, motor reaches max speed. The max speed also depends on the motor specification and power voltage.

Relational graph between duty ratio and the motor speed (closed loop no load)

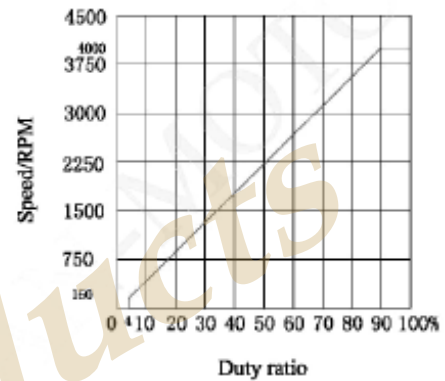

When duty ratio of pulse is 4%, motor speed is 160rpm, when duty ratio is 100%, motor reaches max speed 4000rpm.

7 Status indicator. Exceptional handling

7.1 Status indicator

When over-current, Hall fault, over-temperature, and over voltage occurs, driver will give an alarm signal, and ALM terminal and COM will be in short circuit, ALM terminal will be changed to low level. Motor driver stop working, alarm LED flashes.

Led error display	Status statements	LED display
Red Led flashes twice	Over voltage	<p>ON 1S OFF 1S 5S</p>
Red Led flashes three times	Tube over current	<p>ON 1S OFF 1S 5S</p>
Red Led flashes four times	Over current	<p>ON 1S OFF 1S 5S</p>
Red Led flashes five times	Low voltage	<p>ON 1S OFF 1S 5S</p>
Red Led flashes six times	Hall error	<p>ON 1S OFF 1S 5S</p>
Red Led flashes seven times	Locked-rotor	<p>ON 1S OFF 1S 5S</p>
Red Led flashes eight times	Over two errors	<p>ON 1S OFF 1S 5S</p>

7.2 Exceptional handing

Led error display	Status statements	Solution
Red Led flashes twice	Over voltage	Check the bus voltage
Red Led flashes three times	Tube over current	Ensure model selection is right
Red Led flashes four times	Over current	Check P-sv setting and motor parameter.
Red Led flashes five times	Low voltage	Increase the acceleration time Check power voltage, and ensure power supply is 1.5times of motor power.
Red Led flashes six times	Hall error	Ensure motor connection is well
Red Led flashes seven times	Locked-rotor	Check if motor is overload
Red Led flashes eight times	Over two errors	Hall error or locked-rotor. When speed setting is not available, set P-sv to max value