

2.45 GHz Patch Antenna Array for Direction Finding Applications (Bluetooth LE, AoA)

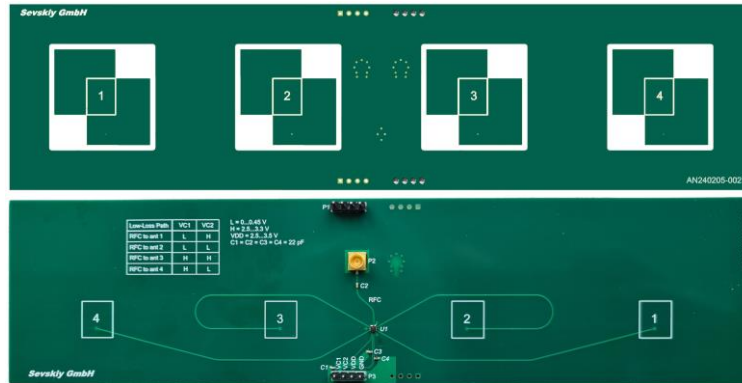

General information

This antenna array is intended to be used in direction finding systems applying Angle of Arrival (AoA) protocol implemented in Bluetooth 5.x. On request, the antenna geometry can be optimized for customer's housing design and material properties. RF switch is integrated on the antenna board.

Typical applications

Bluetooth Low Energy, direction finding systems based on Angle of Arrival (AoA) protocol.

Electrical data

Antenna type	4x1 patch antenna array
Frequency bands	BLE 2450 MHz
Frequency range [MHz]	2400...2500
Return loss [dB]	-15
Peak gain of single array element [dBi]	0.6
Radiation efficiency [%]	25...30
Nominal input impedance [Ohm]	50
Polarization	Circular (RHCP)
Radiation pattern	directional
Maximum input power [dBm]	+32

Mechanical data

Antenna PCB dimensions [mm]	220 x 55 x 1.6
Connector type ¹⁾	SMP or MHF1 ¹⁾
Recommended cable type and thickness ²⁾ [mm]	micro coax 1.13 ²⁾
Recommended cable length ³⁾ [mm]	150 ³⁾
PCB material	FR4

Environmental data

Operating temperature [°C]	-40...+85
Storage temperature [°C]	-40...+85
Ambient relative humidity [%]	0...95
RoHS / REACH compliant	yes / yes

Additional information

¹⁾ Other connector types can be offered on request.

²⁾ Following cable thicknesses can be used with MHF1 connector: 0.81 mm, 1.13 mm, 1.32 mm, 1.37 mm.

³⁾ Recommended length. Cable is not included. Other cable types and lengths can be used.

Other designs, geometries or materials are possible on request.

All information (including technical data and pictures) presented in this document is typical and subject to change without notice. Sevskiy is a registered trade mark of Sevskiy GmbH. Copyright © 2009 - 2023 Sevskiy GmbH. All rights reserved. No warranties.

2.45 GHz Patch Antenna Array for Direction Finding Applications (Bluetooth LE, AoA)

Angle of Arrival (AoA) principle

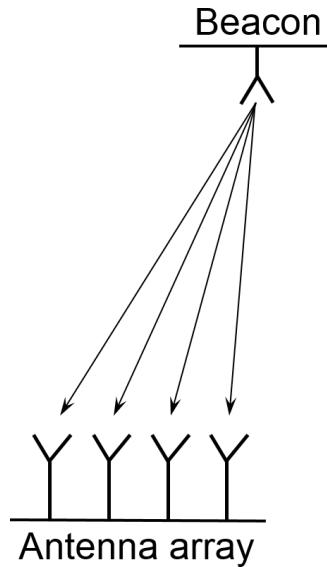

A single-antenna transmit beacon (not included) sends a special direction-finding signal to the antenna array. Angle calculation is based on phase information (phase differences) between the adjacent array antenna elements. The number of antennas in array affects the angle estimation accuracy.

Bluetooth 5.x direction finding Angle of Arrival (AoA) protocol is supported by the following chipsets (not included): nRF5340, nRF52833, nRF52820, nRF52811 (Nordic Semiconductor), EFR32MG13, EFR32BG13, EFR32BG22, EFR32MG22 (Silicon Labs), CC2642, CC2652 (Texas Instruments), CYW54591 (Cypress) and others.

Electrical Specifications of the RF Switch

Parameter	Symbol	Description	Min	Typ	Max
Supply voltage [V]	VDD		2.5	3.3	3.5
Control voltage high [V]	H		2.5	3.0	3.3
Control voltage low [V]	L			0	0.45
Supply current [µA]	IDD			8	10
Switching speed [ns]	SS	50 % CTL to 90 % RF 50 % CTL to 10 % RF		400	500
Rise/fall time [ns]	t _{ON} /t _{OFF}	10% RF to 90 % RF 90 % RF to 10 % RF			500
Startup time [ns]	t _{START}	From VDD off to VDD on		500	1000

All information (including technical data and pictures) presented in this document is typical and subject to change without notice. Sevskiy is a registered trade mark of Sevskiy GmbH. Copyright © 2009 - 2023 Sevskiy GmbH. All rights reserved. No warranties.

2.45 GHz Patch Antenna Array for Direction Finding Applications (Bluetooth LE, AoA)

Control pins description

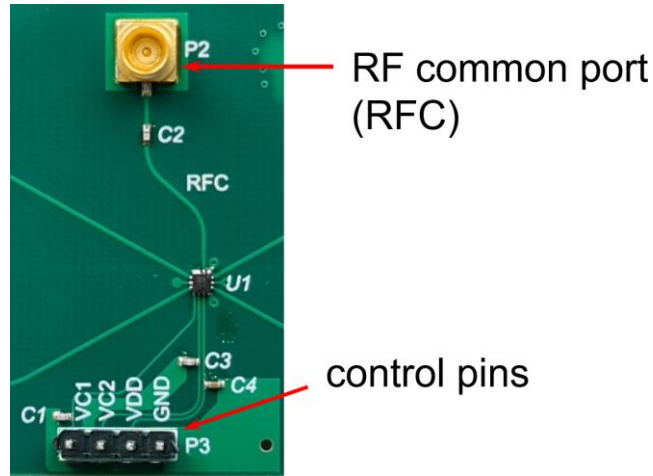

Pin	Name	Description
1	VC1	Control voltage 1
2	VC2	Control voltage 2
3	VDD	Supply voltage
4	GND	Ground

Control signals table for switching individual antennas in antenna array

Low-Loss Path	VC1	VC2
RFC to ant 1	L	H
RFC to ant 2	L	L
RFC to ant 3	H	H
RFC to ant 4	H	L

*H = 2.5...3.3 V, L = 0...0.45 V

All information (including technical data and pictures) presented in this document is typical and subject to change without notice. Sevskiy is a registered trade mark of Sevskiy GmbH. Copyright © 2009 - 2023 Sevskiy GmbH. All rights reserved. No warranties.

2.45 GHz Patch Antenna Array for Direction Finding Applications (Bluetooth LE, AoA)

Product dimensions

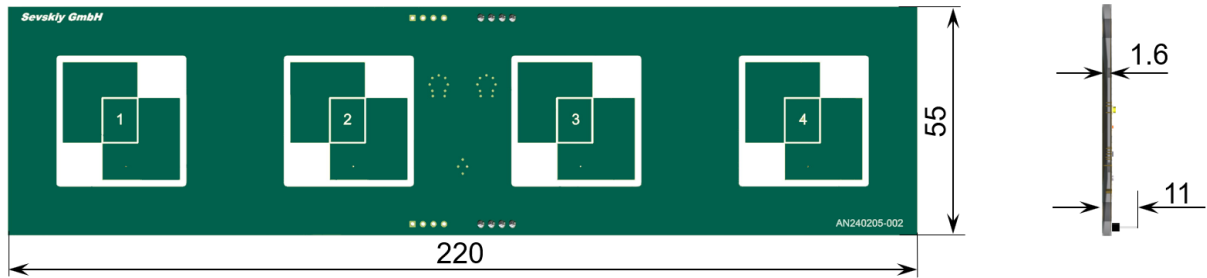

All dimensions are in mm

Measured input impedance matching (4 single elements)

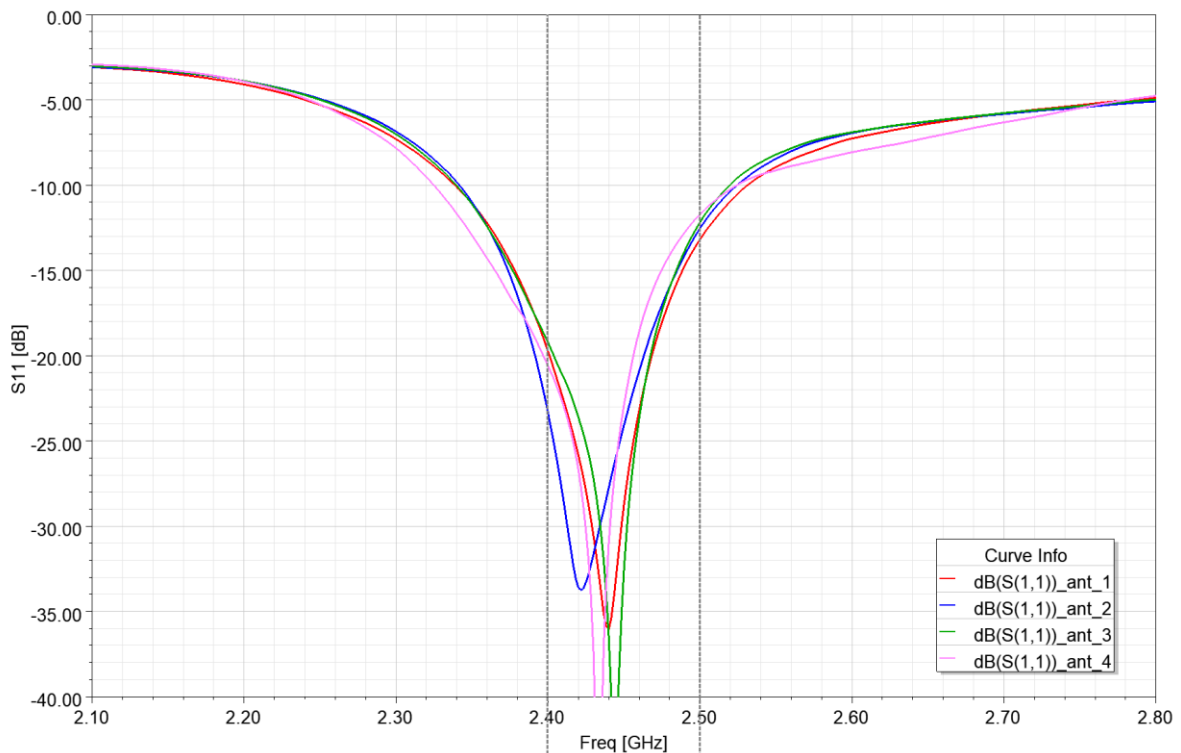

All information (including technical data and pictures) presented in this document is typical and subject to change without notice. Sevskiy is a registered trade mark of Sevskiy GmbH. Copyright © 2009 - 2023 Sevskiy GmbH. All rights reserved. No warranties.

2.45 GHz Patch Antenna Array for Direction Finding Applications (Bluetooth LE, AoA)

Measured radiation pattern (total realized gain) at 2450 MHz

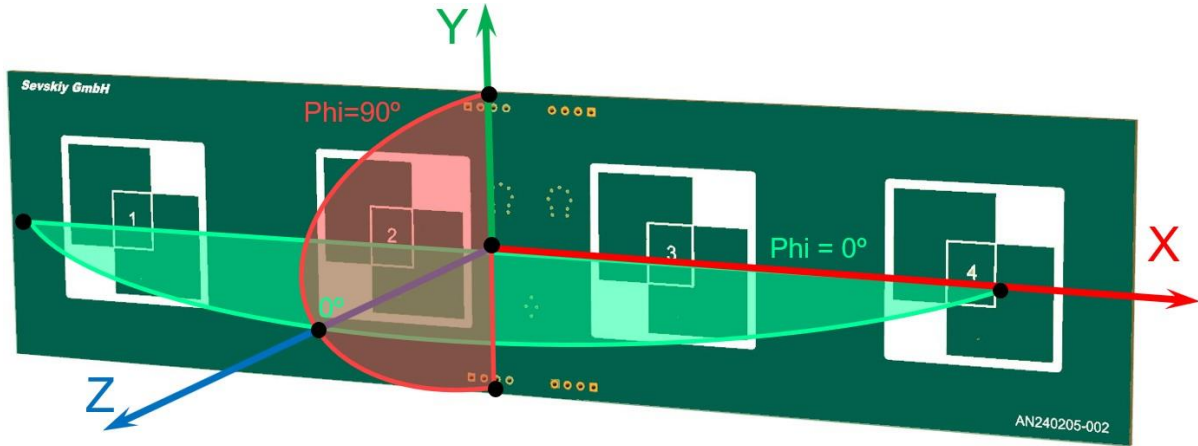

Phi=0°, plane XZ, green curve
Phi=90°, plane YZ, red curve

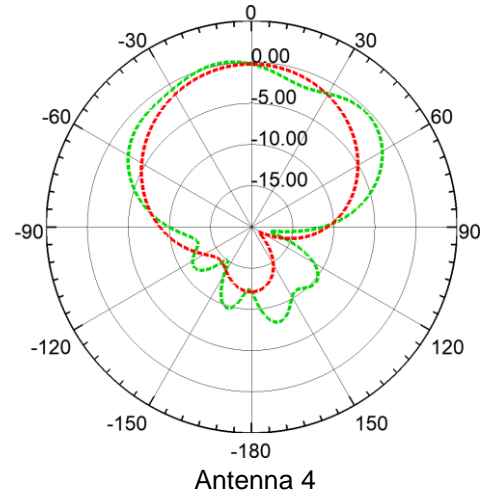
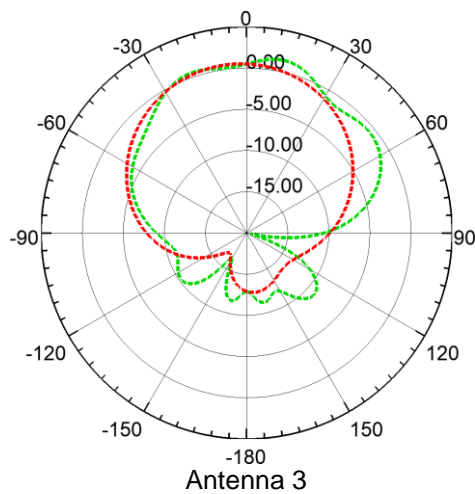
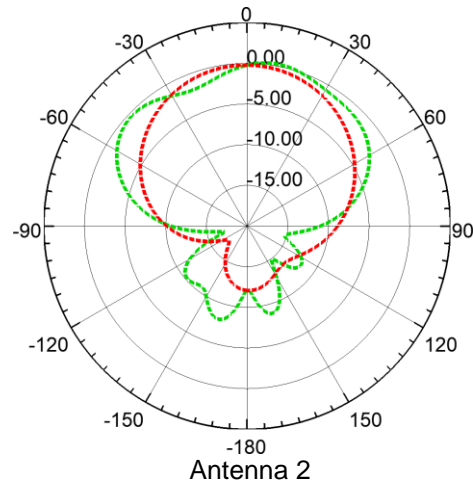
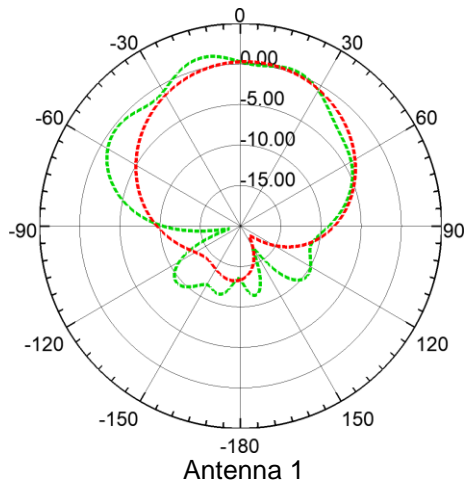

All information (including technical data and pictures) presented in this document is typical and subject to change without notice. Sevskiy is a registered trade mark of Sevskiy GmbH. Copyright © 2009 - 2023 Sevskiy GmbH. All rights reserved. No warranties.